

**METAR
RAIL
WINGLET
GATE
DOMOMAG**
OFFICE FURNITURE MANUFACTURER

metar

grey
oak



IT

rovere grigio,
profili cromati lucidi,
ante in laccato bianco lucido
e rovere grigio, credenza: ante in
laccato bianco lucido e rovere grigio,
armadi ante in vetro retrolaccato
bianco e rovere grigio.

EN

grey oak, glossy chromed profiles,
glossy white lacquered and wood
grey oak doors,
sideboard: glossy white lacquered
doors and wood grey oak,
cabinets white painted glass doors
and wood grey oak.

FR

chêne gris, profils chromés
brillant, portes en laqué blanc
brillant et chêne gris,
desserte: portes en laqué blanc
brillant et chêne gris,
armoires portes en verre laqué
blanc et chêne gris.

DE

Eiche grau, Verchromte Profile
in Hochglanz, Türen in weißer
Hochglanzlack-Ausführung und Eiche grau,
Sideboard: Türen in weißer
Hochglanzlack-Ausführung und Eiche grau,
Schränke: Türen in Glas, rückseitig weiß
lackiert, und Eiche grau.

NL

grijs eiken
hoogglans chroom profielen,
wit gelakte en grijs eiken deuren,
serviceunit: hoogglans wit
gelakte en grijs eiken deuren,
kastdeuren in wit gelakt glas en
grijs eiken.

ES

roble gris,
perfiles cromado brillo,
puertas en lacado blanco brillo
y roble gris, chinero: puertas en
lacado blanco brillo y roble gris,
armarios: puertas de vidrio
retrolacado blanco y roble gris.



IT_Ogni nostra scrivania abbina, al lato estetico, una serie di funzionalità pensate per la migliore ergonomia di lavoro. È il caso dell'elettificazione che rende disponibile l'energia là dove serve.

EN_Our desk combines a pleasing aesthetic with a wide range of features, designed to achieve better ergonomics. Such as the electrification, which makes the power available where needed.



01



02

01 IT_Il canale di salita cavi è dimensionato per il passaggio di una presa Schuko. Il tappo inferiore è removibile per facilitare l'inserimento dei cavi e si mantiene in posizione grazie a due semplici calamite. Il foro superiore, realizzato nella lamiera, è protetto da una ghiera in ABS per non lesionare i cavi nella loro movimentazione. EN_The cable channel is fit for a Schuko socket. The lower cap is detachable to facilitate the cable insertion and is locked into position thanks to two magnets. The upper hole, made in the sheet metal, is protected by an ABS ferrule in order to avoid any damage to the cables. FR_La goulotte verticale de passage des câbles est dimensionnée pour pouvoir accueillir une prise Schuko. Le bouchon inférieur est amovible pour faciliter l'entrée des câbles et reste en place grâce à deux aimants. Le trou supérieur, réalisé dans la tôle, est protégé par un anneau passe-câbles fileté en ABS pour éviter tout cisaillement des câbles dans leurs mouvements. DE_Der Kabelkanal ist auf die Größe einer Schuko-Steckdose ausgelegt. Der untere Deckel ist abnehmbar, um das Durchführen der Kabel zu erleichtern. Er wird durch zwei einfache Magnete in Position gehalten. Die obere Bohrung im Blech wird durch einen Ring aus ABS-Kunststoff geschützt, damit die Kabel bei der Durchführung nicht beschädigt werden. NL_De kabelgoot is aangepast aan de afmetingen van een Schuko-stekker. De onderste dop kan verwijderd worden, waardoor de kabels eenvoudig geplaatst kunnen worden. De dop wordt op zijn plaats gehouden met behulp van twee magneten. De bovenste opening wordt beschermd door een ring in ABS, om te vermijden dat de kabels beschadigd raken wanneer ze bewegen. ES_El conducto por donde suben los cables está dimensionado para el paso de un enchufe Schuko. La tapa inferior se puede quitar para facilitar la introducción de los cables y se mantiene en su sitio gracias a dos simples imanes. El orificio superior, realizado en la chapa, está protegido por una virola de ABS para no dañar los cables al moverlos.

02 IT_Nel decoro che caratterizza il piano di Metar, è realizzato il passaggio dei cavi che si rendono poi disponibili attraverso una piastrina zavorrata dimensionata per attacchi RJ, telefono e dati. EN_The cable guidance is achieved on the decorated Metar surface and the cables are available through a plate fit for RJ, phone and data connections. FR_Dans le décor qui caractérise le plan de travail de Metar, le passage des câbles s'effectue à travers à travers une platine lestée dimensionnée pour connecteurs RJ45, téléphone et données. DE_Bei der Metar-Tischplatte ist die Kabeldurchführung mit einer entsprechend dimensionierten Platte für RJ-Anschlüsse, Telefon und Datenkabel versehen. NL_Het tafelblad van Metar bevat een doorgang voor de kabels, die ter beschikking worden gesteld via een plaatje met de afmetingen voor RJ-aansluitingen, telefoon en gegevensverkeer. ES_En la decoración que caracteriza el sobre de Metar, está realizado el paso de los cables que pueden ser utilizados mediante una plaquita dimensionada para conexiones RJ, teléfono y datos.

FR_Chacun de nos bureaux associe au côté esthétique une série de fonctions pensées pour la meilleure ergonomie. C'est le cas de l'électrification amène l'énergie là où on en a besoin.

DE_Bei jedem unserer Schreibtische gesellt sich zur hohen Ästhetik eine Reihe von Funktionen, die auf eine maximale Ergonomie des Arbeitsplatzes ausgerichtet sind. Z.B. entsprechende Kabelschächte- und durchführungen, damit der Strom auch dort verfügbar ist, wo er benötigt wird.

NL_Onze schrijftafel combineert het esthetische met het functionele, met een verbeterde ergonomie tot gevolg. Stroomkabels kunnen naar elke punt gebracht worden waar ze nodig zijn.

ES_Cada una de nuestras mesas combina la parte estética con una serie de elementos funcionales concebidos para conseguir la mejor ergonomía a la hora de trabajar. Es el caso de la electrificación, para poner a disposición la energía donde haga falta.

IT
rovere grigio,
ante in laccato bianco
lucido e rovere grigio,
base cromata lucida.

EN
grey oak,
glossy white lacquered
and wood grey oak doors,
glossy chromed base.

FR
chêne gris,
portes en laqué blanc
brillant et chêne gris,
piètement chromé brillant.

DE
Eiche grau,
Türen in weißer Hochglanzlack-
Ausführung und Eiche grau,
Verchromtes Gestell in Hochglanz.

NL
grijs eiken,
hoogglans wit gelakte en
grijs eiken deuren,
hoogglans chroom onderstel.

ES
roble gris,
puertas en lacado blanco
brillo y roble gris,
base cromada brillo.



IT
rovere grigio_
ante in laccato bianco lucido
e piani rovere grigio_
base cromata lucida_

EN
grey oak_
glossy white lacquered and
wood grey oak doors_
glossy chromed base_

FR
chêne gris_
portes en laqué blanc brillant
et plateau en chêne gris_
piètement chromé brillant_

DE
Eiche grau_
Türen in weißer Hochglanzlack-
Ausführung und Eiche grau_
Verchromtes Gestell in Hochglanz_

NL
grijs eiken_
hoogglsans wit gelakte en
grijs eiken bladen_
hoogglsans chroom onderstel_

ES
roble gris_
puertas en lacado blanco
brillo y roble gris_
base cromada brillo_

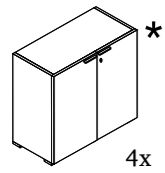

armadi · cabinets · armoires
Schränke · kasten · armarios

100 x 46 x 78,8 cm

I fianchi e i top sono obbligatori
*indicazioni tecniche a pag. 63
Closing sides and tops are compulsory
*see technical info on p. 63
Les côtés de fermeture et les tops sont obligatoires
*voyez les informations techniques sur p. 63
Ein Paar Seitenverkleidungen und eine
Schränkabdeckplatte sind obligatorisch
*siehe technische Informationen über p. 63
De verplichte en de toppen zijn verplicht
*zie technische info op p. 63
Los par de costados y las tapas son obligatorios
*ver información técnica en la pág. 63

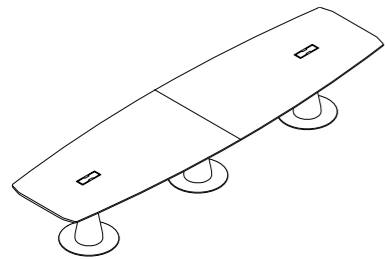

tavoli riunione · meeting tables
tables de reunion · konferenztische
conferentietafel · mesas reuniones

440 (2 x 220) x 90/120 x 75 cm



metar

hidden

qualities

IT_Metar è abbinato ad una serie di contenitori che permettono non solo di gestire l'archiviazione, ma di essere complementi di arredo coerenti, per finiture e materiali, con le scrivanie o i tavoli meeting.

EN_Metar matches a series of containers which allow to manage storage and which perfectly coordinate, for material and finish, to the desks and meeting tables.

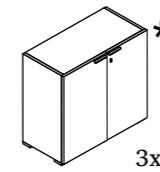

armadi · cabinets · armoires
Schränke · kasten · armarios

100 x 46 x 78,8 cm

I fianchi e i top sono obbligatori
*indicazioni tecniche a pag. 63
Closing sides and tops are compulsory
*see technical info on p. 63
Les côtés de fermeture et les tops sont obligatoires
*voyez les informations techniques sur p. 63
Ein Paar Seitenverkleidungen und eine Schrankabdeckplatte sind obligatorisch
*siehe technische Informationen über p. 63
De verplichte en de toppen zijn verplicht
*zie technische info op p. 63
Los par de costados y las tapas son obligatorios
*ver información técnica en la pág. 63

FR_Metar est associé à une série de meubles qui permettent non seulement de gérer l'archivage, mais aussi de constituer des compléments d'ameublement cohérents, quant aux finitions et aux matériaux, avec les bureaux ou les tables de réunion.

DE_Metar wird mit einer Reihe von Behälterelementen kombiniert, die nicht nur für jede Menge Stauraum sorgen, sondern im Hinblick auf Finish und Materialien auch optisch eine perfekte Ergänzung zu den Schreib- oder Besprechungstischen darstellen.

NL_Metar wordt gecombineerd met een reeks opbergvakken. Dankzij de afwerkingen en de materialen kunnen ze ook als accessoires gebruikt worden bij bureaus of vergadertafels.

ES_Metar combina con una serie de muebles contenedores que permiten tener ordenado el material archivado, pero al mismo tiempo son complementos de decoración conjuntados, por sus acabados y materiales, con las mesas de trabajo y de dirección.



01

01 IT_La finitura è in essenza rovere nel tono grigio che permette di esaltare la naturale vena del vero legno. Il top è in spessore da 13 mm, mentre le ante sono in spessore da 19 mm con cerniere con chiusura soft. EN_The grey oak essence of the finish enhances the real wood natural veining. The table top has a thickness of 13 mm, while the doors have a thickness of 19 mm and are equipped with soft-close hinges. FR_La finition est en essence de chêne teinté gris qui met en valeur le veinage naturel du bois. Le dessus a une épaisseur de 13 mm, tandis que les portes ont une épaisseur de 19 mm et sont équipées de charnières avec fermeture amortie. DE_Das Finish in massiver grauer Eiche sorgt dafür, dass die natürliche Maserung des Echtholzes optimal zur Geltung kommt. Die Oberseite weist eine Dicke von 13 mm auf, die Türen sind 19 mm dick und haben Scharniere mit Soft Close-System.

NL_De grijs eiken afwerking accentueert de natuurlijke nerven van het echte hout. Het bovenblad is 13 mm dik; de deuren zijn 19 mm dik en beschikken over scharnieren met zachte sluiting. ES_El acabado es en madera de roble en un tono gris que permite resaltar el veteadado natural de la autentica madera. La tapa del mueble tiene un espesor de 13 mm, mientras que las puertas tienen un espesor de 19 mm con bisagras de cierre lento.

02 IT_Nei moduli con larghezza 500 mm è possibile inserire il mini frigorifero 380x410x525 mm (LxPxH). Il vano è già predisposto con una presa d'aria fresata sulla schiena. EN_The 500 mm large modules can be equipped with a mini fridge 380x410x525 mm (WxLxH). The cabinet is already fitted with a milled grille on the back. FR_Dans les modules de 500 mm de largeur, il est possible d'encastrer le mini réfrigérateur 380x410x525 mm (LxPxH). Le compartiment prévoit déjà une prise d'air obtenue par fraisage du panneau arrière. DE_In den Modulen mit 500 mm Breite ist Platz für den Minikühlschrank 380x410x525 mm (LxPxH). Das Fach ist bereits mit einem in die Rückseite eingefrästen Lüftungsschacht versehen. NL_In modules die 50 cm breed zijn, kunt u de minikoelkast 380x410x525 mm (PxLxH) plaatsen. De desbetreffende ruimte beschikt reeds over een ventilatieopening aan de achterkant. ES_En los módulos con ancho de 50 cm se puede meter una nevera pequeña 380x410x525 mm (FxAxH). El hueco ya está preparado con una toma de aire fresada en la parte posterior.



02



01

01 *IT* Le ante vetro hanno uno spessore da 4 mm e sono laccate internamente con una verniciatura a caldo, particolarmente resistente. *EN* The glass doors have a thickness of 4 mm and are lacquered on the inside through a highly resistant hot varnishing. *FR* Les portes vitrées ont une épaisseur de 4 mm et sont laquées sur la face interne avec une peinture à chaud particulièrement résistante. *DE* Die Glastüren sind 4 mm dick und innen mit einem besonders widerstandsfähigen Heißlack überzogen. *NL* De glazen deuren zijn 4 mm dik en zijn intern behandeld met bijzonder duurzame warmgespoten verf. *ES* Las puertas de vidrio tienen un espesor de 4 mm y están lacadas internamente con una barnizado en caliente, particularmente resistente.

02 *IT* L'organizzazione interna dell'armadio può prevedere l'applicazione di un rigo appendiabiti. Le cerniere delle ante sono con chiusura soft. *EN* The cabinets can also be equipped with a coat pole. The doors are equipped with soft-close hinges. *FR* L'organisation interne de l'armoire peut prévoir l'application d'une tringle à vêtements. Les charnières des portes sont avec fermeture amortie. *DE* Im Inneren des Schrankes ist die Unterbringung einer Kleiderstange möglich. Die Scharniere der Türen sind mit Soft Close-System ausgestattet. *NL* De binnenkant van de kast is zodanig ingericht dat u een kapstok kunt aanbrengen. De scharnieren zijn uitgerust met zachte sluiting. *ES* La organización interna del armario puede llevar la aplicación de un listón para colgar ropa. Las bisagras de las puertas llevan un cierre lento.



02

03 *IT* Sempre le ante a vetro sono inserite in un telaio in alluminio con finitura ossidato brillante. *EN* The glass doors are inserted into an aluminium structure with glossy oxidised finish. *FR* Les portes vitrées sont munies d'un cadre en aluminium avec finition anodisée brillante. *DE* Die Glastüren sind in einen Aluminiumrahmen mit glanzeloxiertem Finish eingebaut. *NL* De glazen deuren zijn omgeven door een aluminium frame met geoxideerde glanzende afwerking. *ES* Las puertas de vidrio siempre van en un bastidor de aluminio con acabado óxido brillo.

04 *IT* La tenuta alla chiusura dell'anta, è garantita da un'asta in metallo che corre lungo tutta l'altezza dell'anta stessa. *EN* The perfect closing of the doors is ensured by a metal rod which extends for the entire length of the door. *FR* La tenue à la fermeture de la porte est garantie par une barre en métal sur toute la hauteur du vantaïl. *DE* Die Schließdichtigkeit der Türen wird durch eine Metallstange garantiert, die entlang der gesamten Türhöhe verläuft. *NL* De correcte sluiting van de deur wordt gegarandeerd door een metalen staaf die langs de volledige lengte van de deur loopt. *ES* La resistencia al cierre de la puerta, está garantizada por una varilla de metal que corre a lo largo de toda la altura de la puerta en cuestión.

IT Laddove servono grandi volumi di archiviazione, gli armadi Metar sono attrezzati per contenere in modo ordinato e razionale documenti e accessori.

EN Perfectly suitable for huge volumes of storage, Metar cabinets are fitted to contain documents and accessories in an orderly and rational manner.

FR Quand de grands volumes d'archivage sont nécessaires, les armoires Metar sont équipées pour accueillir de manière ordonnée et rationnelle les documents et les accessoires.

DE Die Metar-Schränke sind auf maximalen Stauraum ausgelegt und so ausgestattet, dass Dokumente und Büromaterialien ordentlich und übersichtlich untergebracht werden können.



04



03

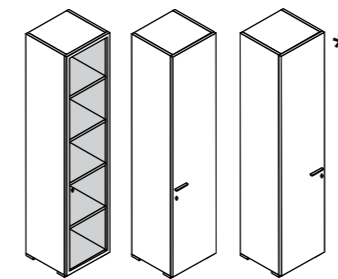
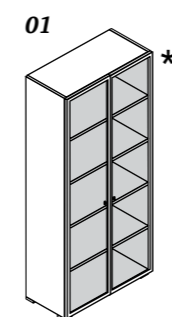

armadi · cabinets · armoires
Schränke · kasten · armarios

100 x 46 x 194 cm
50 x 46 x 194 cm

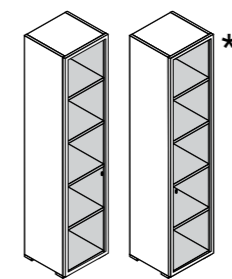
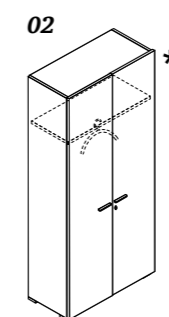

armadi · cabinets · armoires
Schränke · kasten · armarios

100 x 46 x 194 cm
50 x 46 x 194 cm

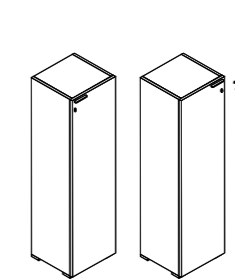
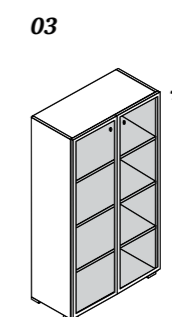

armadi · cabinets · armoires
Schränke · kasten · armarios

100 x 46 x 155,6 cm
50 x 46 x 155,6 cm

NL De kasten van Metar zijn ideaal om op ordelijke en logische wijze documenten en accessoires op te bergen als u behoefte heeft aan veel opslagruimte.

ES Allí donde sean necesarios grandes volúmenes de archivo, los armarios Metar están preparados para contener de manera ordenada y racional documentos y accesorios.

I fianchi e i top sono obbligatori
*indicazioni tecniche a pag. 63
Closing sides and tops are compulsory
*see technical info on p. 63
Les côtés de fermeture et les tops sont obligatoires
*voyez les informations techniques sur p. 63
Ein Paar Seitenverkleidungen und eine Schrankabdeckplatte sind obligatorisch
*siehe technische Informationen über p. 63
De verplichte en de toppen zijn verplicht
*zie technische info op p. 63
Los par de costados y las tapas son obligatorios
*ver información técnica en la pág. 63

metar

composition elements
& dimensions

grey oak

6/7

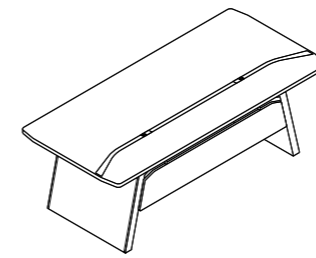

scrivania in legno · wooden desk
bureaux en bois · holz-schreibtische
houten bureaus · escritorio de madera

L x P x H

240 x 100 x 75 cm

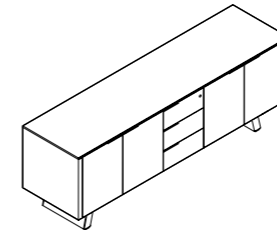

modesty panel · modesty panel
voile de fond · knieraublenden
bureauborden · panela para escritorio

160,6 x 1,9 x 41,3 cm

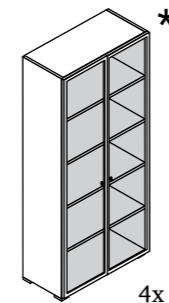

credenze · sideboards · dessert
glauben · geloof · creencia

216 x 57,4 x 75 cm

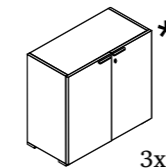

armadi · cabinets · armoires
Schränke · kasten · armarios

100 x 46 x 194 cm

armadi · cabinets · armoires
Schränke · kasten · armarios

50 x 46 x 78,8 cm

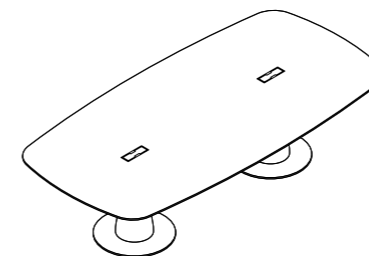

tavoli riunione · meeting tables
tables de reunion · konferenztische
conferentietafel · mesas reuniones

280 x 120 x 75 cm

10/11

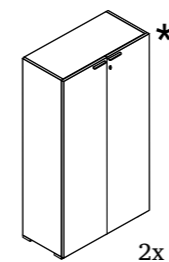

armadi · cabinets · armoires
Schränke · kasten · armarios

L x P x H

100 x 46 x 155,6 cm

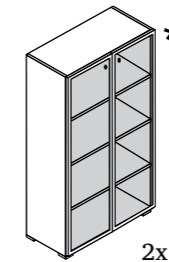

tavoli riunione · meeting tables
tables de reunion · konferenztische
conferentietafel · mesas reuniones

220 x 110 x 75 cm

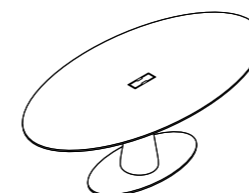

I fianchi e i top sono obbligatori *indicazioni tecniche a pag. 63 · Closing sides and tops are compulsory *see technical info on p. 63 · Les côtés de fermeture et les tops sont obligatoires *voyez les informations techniques sur p. 63 · Ein Paar Seitenverkleidungen und eine Schrankabdeckplatte sind obligatorisch *siehe technische Informationen über p. 63 · De verplichte en de toppen zijn verplicht *zie technische info op p. 63 · Los par de costados y las tapas son obligatorias *ver información técnica en la pág. 63

metar

white
lacquered
oak



IT

piani in rovere laccato bianco,
ante in laccato nebbia lucido
e rovere laccato bianco,
profili cromati lucidi,
base cromata lucida.

EN

white lacquered oak desk tops,
glossy light grey lacquered
and white oak doors,
glossy chromed profiles,
glossy chromed base.

FR

Plateau en chêne laqué blanc,
portes en laqué brouillard
brillant et chêne laqué blanc,
profils chromés brillants,
piètement chromé brillant.

DE

Tischplatten Eiche weiß lackiert,
Türen in nebelgrauer Hochglanzlack-
Ausführung und Eiche weiß lackiert,
Verchromte Profile in Hochglanz,
Verchromtes Gestell in Hochglanz.

NL

Bladen in wit gelakt eiken,
hoogglans mistgrijs en wit
gelakte eiken deuren,
hoogglans chroom profielen,
hoogglans chroom onderstel.

ES

roble lacado blanco,
puertas en lacado niebla
brillo y roble lacado blanco,
perfiles cromados brillo,
base cromada brillo.



IT
rovere laccato bianco,
profili cromati lucidi,
ante in vetro retrolaccato nero
e rovere laccato bianco.

EN
white lacquered oak desk tops,
glossy chromed profiles,
black painted glass and
white lacquered oak doors.

FR
chêne laqué blanc,
profils chromés brillants,
portes en verre laqué noir
et chêne laqué blanc.

DE
Eiche weiß lackiert,
Verchromte Profile in Hochglanz,
Türen in Glas, rückseitig schwarz
lackiert, und Eiche weiß lackiert.

NL
wit gelakt eiken,
hoogglans chroom profielen,
kastdeuren in zwart gelakt glas
en wit gelakt eiken.

ES
roble lacado blanco,
perfiles cromado brillo,
puertas de vidrio retrolacado
negro y roble lacado blanco.



IT_Il legno di rovere ha una particolare finitura che lo rende caldo e vellutato al tatto mentre la finitura bianca esalta il segno delle venature.

EN_The oak wood has a peculiar finish which makes it warm and velvety, while the white finish enhances the veining.

FR_Le bois de chêne a une finition particulière qui le rend chaud et velouté au toucher; la finition blanche met en valeur les veines.

DE_Eichenholz hat eine besondere Oberfläche mit einem warmen, samtigen Griff; das weiße Finish bringt die Maserung besonders zu Geltung.

NL_Eikenhout wordt gekenmerkt door een bijzondere afwerking die warm en zacht aanvoelt; de witte afwerking accentueert de houtnerf.

ES_la madera de roble tiene un particular acabado que le proporciona un tacto cálido y aterciopelado; el acabado blanco resalta el veteado.

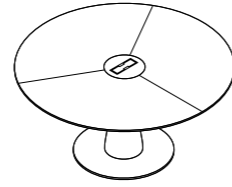

tavoli riunione · meeting tables
tables de reunion · konferenztische
conferentietafel · mesas reuniones

Ø 160 x 75 cm



01



02

01 IT_Il basamento è dimensionato per una perfetta stabilità alla quale concorre anche la solidità dell'acciaio presentato in finitura cromata. EN_The base dimensions allow a perfect stability, enhanced also by the soundness of the chromed steel. FR_Le piètement est dimensionné pour une stabilité parfaite à laquelle contribue aussi la solidité de l'acier dans la finition chromée. DE_Der Unterbau ist auf eine perfekte Stabilität ausgelegt, zu der auch die Robustheit des Stahls mit Chromfinish beiträgt. NL_De afmetingen van het onderstel en het stevige staal van de gechromeerde afwerking garanderen een perfecte stabiliteit. ES_El soporte está dimensionado por una perfecta estabilidad a la que contribuye la solidez del acero presentado en acabado cromado.

02 IT_Lo sportello in finitura permette un facile accesso alle connessioni di rete e ai cablaggi. EN_The surface flap allows an easy access to network connections and cables. FR_Le couvercle dans la même finition permet d'accéder facilement aux connexions de réseau et aux câblages. DE_Die Klappe oben in der Tischplatte ermöglicht einen einfachen Zugang zu den Netzanschlüssen und Kabeln. NL_Dankzij de afgewerkte deur zijn de netwerkaansluitingen en bekabelingen gemakkelijk toegankelijk. ES_La puerta con su acabado permite un fácil acceso a las conexiones de red y al cableado.

IT_La salita cavi avviene attraverso una feritoia ricavata nel basamento; ciò permette un facile accesso, una salita senza intoppi, diretta allo sportello presente sul piano.

EN_The cable channel is obtained through an opening on the base; this allows an easy access and a seamless passage to the surface flap.

FR_Le passage des câbles s'effectue à travers une fente ménagée dans le piètement; cela permet un accès aisé et une remontée sans obstacles jusqu'au couvercle présent sur le plan.

DE_Die Kabeldurchführung erfolgt über einen in den Unterbau integrierten Spalt; dies ermöglicht einen einfachen Zugang und ein ungehindertes Durchführen direkt zur Klappe auf der Tischfläche



03

NL_De kabels worden omhoog gebracht door een opening in het onderstel. Hierdoor zijn ze gemakkelijk toegankelijk en kunnen ze zonder problemen omhoog geduwd worden naar het luikje dat zich op de blad bevindt.

ES_Los cables suben por una ranura realizada en el soporte; esto permite un fácil acceso, una subida de los cables sin tropiezos, directa a la puerta presente en el sobre.

metar

composition elements
& dimensions

white
lacquered
oak

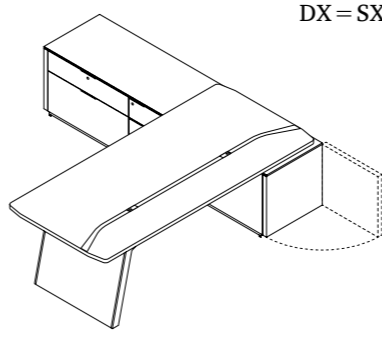
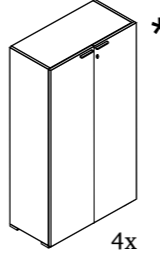
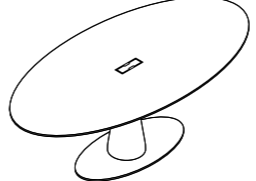
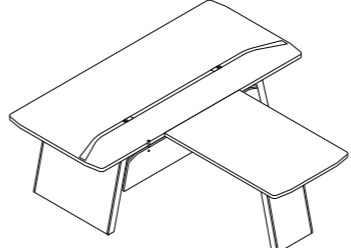
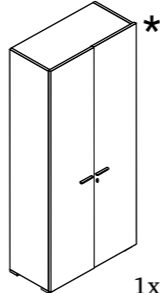
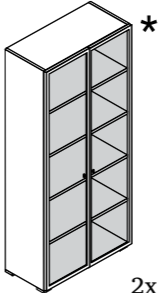
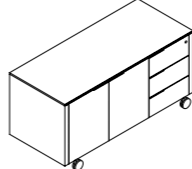
22/23		L x P x H
 <p>DX = SX</p>  <p>*</p> <p>4x</p> 	<p>scrivania in legno · wooden desk bureaux en bois · holz-schreibtische houten bureaus · escritorio de madera</p> <p>moduli di servizio · service modules elements de service · multifunktionscontainer servicemodulen · elementos de servicio</p> <p>armadi · cabinets · armoires Schränke · kasten · armarios</p> <p>tavoli riunione · meeting tables tables de reunion · konferenztische conferentietafel · mesas reuniones</p>	<p>240 x 100 x 75 cm</p> <p>229 x 57,4 x 58,3 cm</p> <p>100 x 46 x 155,6 cm</p> <p>220 x 110 x 75 cm</p>
24/25		L x P x H
  <p>*</p> <p>1x</p>  <p>*</p> <p>2x</p> 	<p>scrivania in legno · wooden desk bureaux en bois · holz-schreibtische houten bureaus · escritorio de madera</p> <p>piano conversazione · conversation top plan conversation · platte für gesprächstisch conferentiebladen · plano de conversación</p> <p>modesty panel · modesty panel voile de fond · knieraublenden bureauborden · panela para escritorio</p> <p>armadi · cabinets · armoires Schränke · kasten · armarios</p> <p>moduli di servizio · service modules elements de service · multifunktionscontainer servicemodulen · elementos de servicio</p>	<p>240 x 100 x 75 cm</p> <p>120 x 80 x 75 cm</p> <p>160,6 x 1,9 x 41,3 cm</p> <p>100 x 46 x 194 cm</p> <p>132,7 x 57,4 x 63,8 cm</p>

I fianchi e i top sono obbligatori *indicazioni tecniche a pag. 63 · Closing sides and tops are compulsory *see technical info on p. 63 · Les côtés de fermeture et les tops sont obligatoires *voyez les informations techniques sur p. 63 · Ein Paar Seitenverkleidungen und eine Schrankabdeckplatte sind obligatorisch *siehe technische Informationen über p. 63 · De verplichte en de toppen zijn verplicht *zie technische info op p. 63 · Los par de costados y las tapas son obligatorios *ver información técnica en la pág. 63

metar

black
lacquered
oak



metar

strong, personal
& decisive signature

IT_Questa immagine esalta l'esclusiva personalità di Metar, il suo segno inconfondibile che lo rende perfetto per sottolineare lo status dell'ufficio manageriale.

EN_This image enhances the exclusive personality of Metar, its unique style which makes it a perfect addition to highlight the managing office's status.

FR_Cette image exalte la personnalité exclusive de Metar, le signe unique qui le rend parfait pour souligner le statut du bureau de direction.

DE_Dieses Bild bringt die exklusive Persönlichkeit von Metar und seinen unverwechselbaren Charakter zum Ausdruck, der den Status des Managerbüros optimal unterstreicht.

NL_Deze afbeelding accentueert de exclusieve persoonlijkheid van Metar, die op een unieke wijze de status van een managerskantoor benadrukt.

ES_Esta imagen resalta la personalidad exclusiva de Metar, su marca inconfundible que la hace perfecta para subrayar el estatus de los despachos de dirección.



IT
rovere laccato nero_
profili cromati lucidi_
moduli di servizio ante in
laccato bianco lucido_ armadi
ante in vetro retrolaccato
bianco e rovere laccato nero_

EN
black lacquered oak_
glossy chromed profiles_
service modules glossy white
lacquered doors_
cabinets white painted glass
and black lacquered oak_

FR
chêne laqué noir_
profils chromés brillants_
éléments de service portes
en laqué blanc brillant_
armoires portes en verre laqué
blanc et chêne laqué noir_

DE
Eiche schwarz lackiert_
Verchromte Profile in Hochglanz_
Multifunktionscontainer Türen in weißer
Hochglanzlack-Ausführung und Eiche grau_
Schränke Türen in Glas, rückseitig weiß
lackiert, und schwarz lackierter Eiche_

NL
zwart gelakt eiken_
hoogglans chroom profielen_
serviceunit hoogglans wit
gelakte deuren_
kastdeuren in wit gelakt glas en
zwart gelakt eiken_

ES
roble lacado negro_
perfiles cromado brillo_
modulos de servicio puertas en lacado
blanco brillo_
armarios puertas de vidrio retrolacado
blanco y roble lacado negro_



metar

composition elements
& dimensions

black lacquered oak

32/33

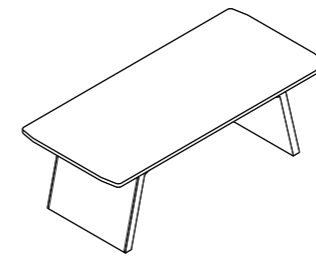

scrivania in legno · wooden desk
bureaux en bois · holz-schreibtische
houten bureaus · escritorio de madera

L x P x H

240 x 100 x 75 cm

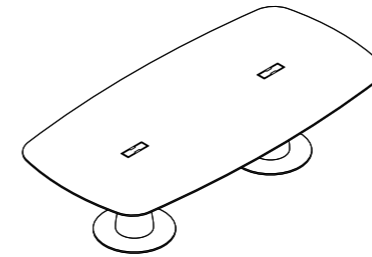

tavoli riunione · meeting tables
tables de reunion · konferenztische
conferentietafel · mesas reuniones

280 x 120 x 75 cm

34/35

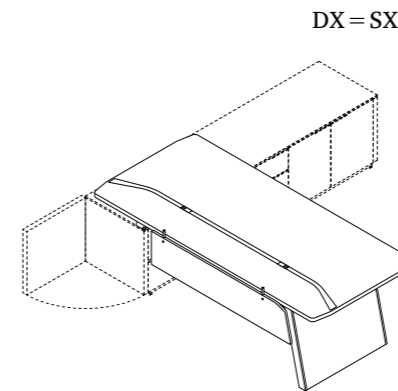

scrivania in legno · wooden desk
bureaux en bois · holz-schreibtische
houten bureaus · escritorio de madera

240 x 100 x 75 cm

modesty panel · modesty panel
voile de fond · knieraublenden
bureauborden · panela para escritorio

141,5 x 1,9 x 41,3 cm

moduli di servizio · service modules
elements de service · multifunktionscontainer
servicemodulen · elementos de servicio

229 x 57,4 x 58,3 cm

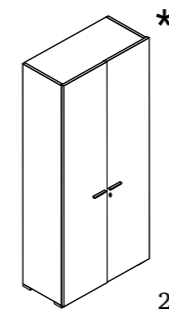

2x

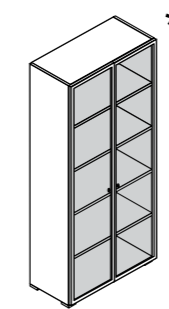

1x

armadi · cabinets · armoires
Schränke · kasten · armarios

100 x 46 x 194 cm

I fianchi e i top sono obbligatori *indicazioni tecniche a pag. 63 · Closing sides and tops are compulsory *see technical info on p. 63 · Les côtés de fermeture et les tops sont obligatoires *voyez les informations techniques sur p. 63 · Ein Paar Seitenverkleidungen und eine Schrankabdeckplatte sind obligatorisch *siehe technische Informationen über p. 63 · De verplichte en de toppen zijn verplicht *zie technische info op p. 63 · Los par de costados y las tapas son obligatorias *ver información técnica en la pág. 63

metar

tobacco
oak



IT

struttura in rovere tabacco,
ante in laccato nebbia lucido,
profili cromati lucidi,
base cromata lucida.

EN

tobacco oak structure,
glossy light grey lacquered
doors, glossy chromed
profiles, glossy chromed base.

FR

structure en chêne tabac,
portes en laqué brouillard brillant,
profils chromés brillants,
piètement chromé brillant.

DE

Korpus aus Eiche Tabak,
Türen in Nebelgrauer Hochglanzlack-Ausführung,
Verchromte Profile in Hochglanz,
Verchromtes Gestell in Hochglanz.

NL

Romp in tabakskleurig eiken,
deuren in hoogglans gelakte
mistkleur hoogglans chroom profielen,
hoogglans chroom onderstel.

ES

estructura en roble tabaco,
puertas en lacado niebla brillo,
perfiles cromados brillo,
base cromada brillo.



IT

struttura in rovere tabacco,
ante in laccato tortora lucido,
profili cromati lucidi,
base cromata lucida.

EN

tobacco oak structure,
glossy turtledove lacquered doors,
glossy chromed profiles,
glossy chromed base.

FR

structure en chêne tabac,
portes en laqué tourterelle brillant,
profils chromés brillants,
piètement chromé brillant.

DE

Korpus aus Eiche Tabak,
Türen in Taubengrauer Hochglanzlack-Ausführung,
Verchromte Profile mit in Hochglanz,
Verchromtes Gestell in Hochglanz.

NL

Romp in tabakskleurig eiken,
deuren in hoogglans gelakte tortelduif
kleur hoogglans chroom profielen,
hoogglans chroom onderstel.

ES

estructura en roble tabaco,
puertas en lacado tórtola brillo,
perfiles cromados brillo,
base cromada brillo.



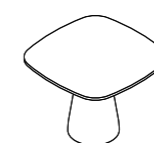

tavolini da caffè · coffee tables
table basse · couchtisch
salontafel · mesita para cortado

60 x 60 x 51 cm

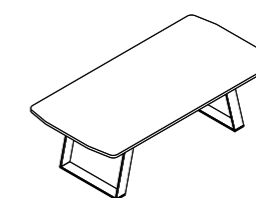

tavolini da caffè · coffee tables
table basse · couchtisch
salontafel · mesita para cortado

120 x 60 x 40 cm

metar

status,
function
& prestige

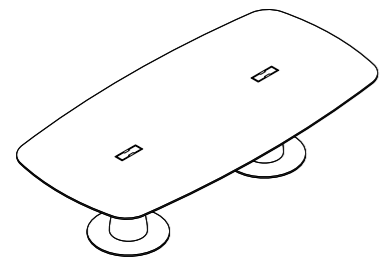

tavoli riunione · meeting tables
tables de reunion · konferenztische
conferentietafel · mesas reuniones

280 x 120 x 75 cm



metar

composition elements
& dimensions

tobacco oak

40/41

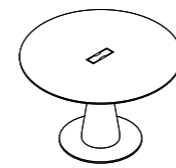
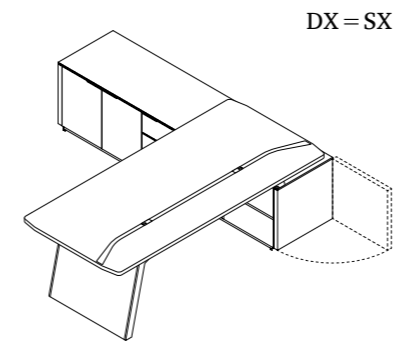

scrivania in legno · wooden desk
bureaux en bois · holzschreibtische
houten bureaus · escritorio de madera

moduli di servizio · service modules
elements de service · multifunktionscontainer
servicemodulen · elementos de servicio

tavoli riunione · meeting tables
tables de reunion · konferenztische
conferentietafel · mesas reuniones

L x P x H

240 x 100 x 75 cm
229 x 57,4 x 58,3 cm

Ø 120 x 75 cm

42/43

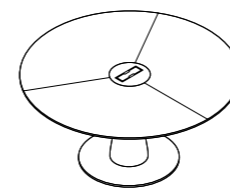
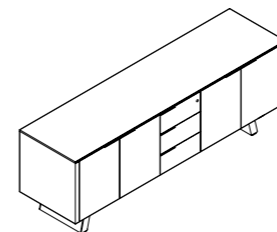
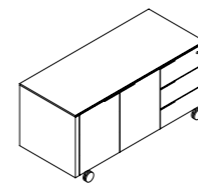
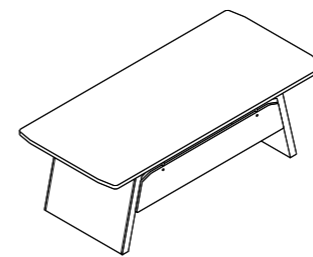

scrivania in legno · wooden desk
bureaux en bois · holzschreibtische
houten bureaus · escritorio de madera

modesty panel · modesty panel
voile de fond · knieraublenden
bureauborden · panela para escritorio

moduli di servizio · service modules
elements de service · multifunktionscontainer
servicemodulen · elementos de servicio

credenze · sideboards · dessert
glauben · geloof · creencia

tavoli riunione · meeting tables
tables de reunion · konferenztische
conferentietafel · mesas reuniones

L x P x H

240 x 100 x 75 cm
160,6 x 1,9 x 41,3 cm

132,7 x 57,4 x 63,8 cm

216 x 57,4 x 75 cm

Ø 160 x 75 cm

metar

natural
oak

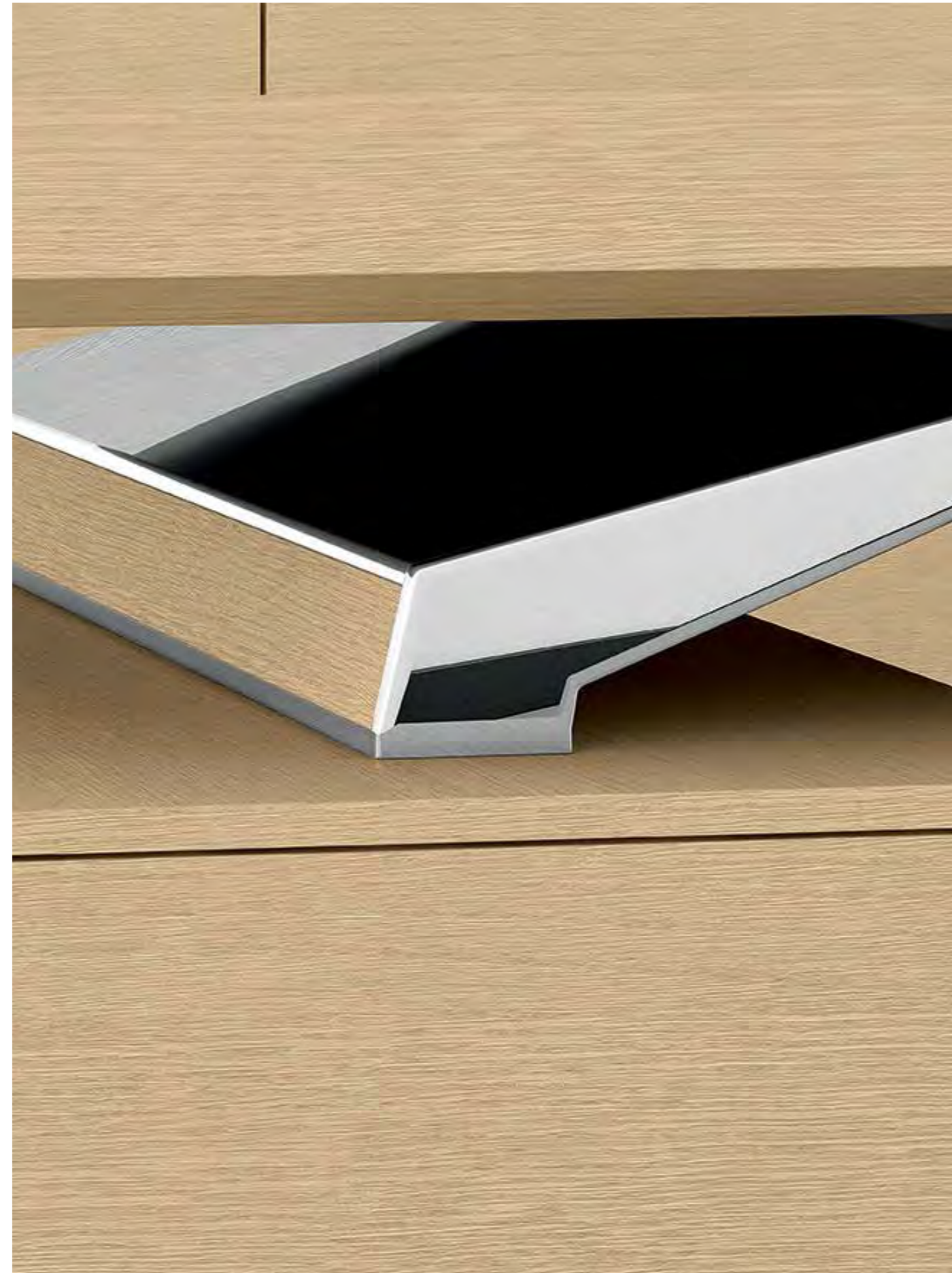

IT
rovere laccato naturale,
ante in laccato bianco lucido e
rovere naturale,
profili cromati lucidi.

EN
natural oak,
glossy white lacquered
and natural oak doors,
glossy chromed profiles.

FR
chêne laqué naturel,
portes en laqué blanc brillant
et chêne naturel,
profils chromés brillants.

DE
Eiche lackiert Natur,
Türen in weißer Hochglanzlack-
Ausführung und Eiche Natur,
Verchromte Profile in Hochglanz.

NL
Blank eiken gelakt,
Deuren in hoogglsans gelakt
wit en blank eiken,
hoogglsans chroom profielen.

ES
roble lacado natural,
puertas en lacado blanco brillo
y roble natural,
perfiles cromados brillo.



01 *IT* Il mobile di servizio sottoscrivania svolge una duplice funzione: sostenere il piano e celare un contenitore. *EN* The service cabinet underneath the desk has a dual function: sustaining the top and hiding a container. *FR* Le meuble de service sous le bureau a une double fonction: soutenir le plan de travail et offrir un espace de rangement. *DE* Das Servicemöbel unter dem Schreibtisch erfüllt eine doppelte Funktion: Es stützt die Tischplatte und verbirgt ein Behälterelement. *NL* Het dienstmeubel onder de tafel heeft een dubbele functie: het blad ondersteunen en een opbergruimte verbergen. *ES* El mueble de servicio bajo la mesa tiene una doble función: sujetar el sobre y ocultar un mueble contenedor.



01

02 *IT* Il vano è facilmente accessibile e permette di ricavare un utile contenimento a bordo della scrivania. *EN* The cabinet is easily accessible and allows to have a useful storage space next to the desk. *FR* Le compartiment est facilement accessible et permet d'obtenir un espace de rangement utile intégré au bureau. *DE* Das Fach ist einfach zugänglich und ermöglicht die Unterbringung eines praktischen Behälters im Schreibtisch. *NL* De ruimte is gemakkelijk toegankelijk en maakt het mogelijk om een nuttige opbergruimte in het bureau te verkrijgen. *ES* El hueco es de fácil acceso y permite sacar una útil contención en el escritorio.



02

03 *IT* Il vano tecnico porta CPU è predisposto con una presa d'aria per la ventilazione, realizzata con una griglia cromata, e un tappo passacavi per rendere disponibile l'energia in modo semplice e diretto. *EN* The CPU cabinet is equipped with a chromed grille air slot for ventilation and with a cable guide cap, to diffuse the power in a simple and direct way. *FR* Le logement technique pour unité centrale possède une prise d'air pour la ventilation, réalisée avec une grille chromée et un couvercle passe-câbles pour rendre l'énergie disponible de manière simple et directe. *DE* Das PC-Fach ist mit einem Lüftungsschacht mit verchromtem Gitter und einem Kabeldurchführungs-Deckel ausgestattet, um für eine einfache und direkte Stromzufuhr zu sorgen. *NL* De technische ruimte voor de CPU is uitgerust met een verluchttingsopening met een gechrommeerd rooster en een kabeldop voor een eenvoudige en rechtstreekse stroomvoorziening. *ES* El hueco técnico para alojar la CPU está preparado con una toma de aire para la ventilación, realizada con una rejilla cromada, y una tapa acceso cableado para que la energía esté a disposición de manera sencilla y directa.



03

IT Un sistema dedicato alle funzioni manageriali deve anche saper rispondere a necessità di lavoro ed utilizzo intensivo, proponendo soluzioni intelligenti ed ergonomiche.

EN A managerial system must also be capable to respond to intense work and use needs, introducing intelligent and ergonomic solutions.

FR Un système dédié aux fonctions de management doit aussi savoir répondre à des besoins de travail et d'utilisation intensive, en proposant des solutions intelligentes et ergonomiques.

DE Ein System speziell für Managerbüros, das auch intensiven Arbeits- und Nutzungsanforderungen gerecht werden soll, indem es intelligente und ergonomische Lösungen bietet.

NL Een systeem dat geschikt is voor beheersfuncties moet ook beantwoorden aan de werkbehoeften en een intensief gebruik, en intelligente en ergonomische oplossingen bieden.

ES Un sistema dedicado a las funciones de dirección, también tiene que saber responder a las necesidades de trabajo y de utilización intensiva, proponiendo soluciones inteligentes y ergonómicas.

metar

formal
elegance

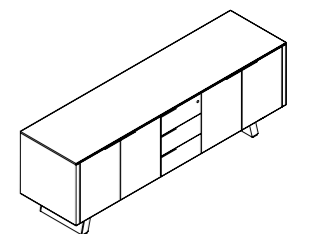

credenze · sideboards · dessert
glauben · geloof · creencia

216 x 57,4 x 75 cm

metar

composition elements
& dimensions

natural oak

52/53

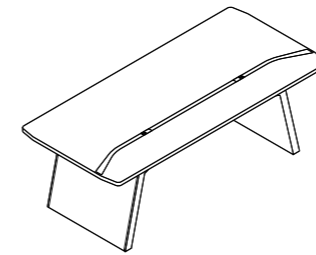

scrivania in legno · wooden desk
bureaux en bois · holzschreibtische
houten bureaus · escritorio de madera

L x P x H

240 x 100 x 75 cm

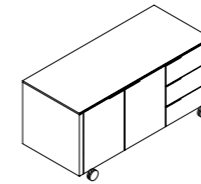

moduli di servizio · service modules
elements de service · multifunktionscontainer
servicemodulen · elementos de servicio

132,7 x 57,4 x 63,8 cm

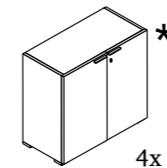

armadi · cabinets · armoires
Schränke · kasten · armarios

100 x 46 x 78,8 cm

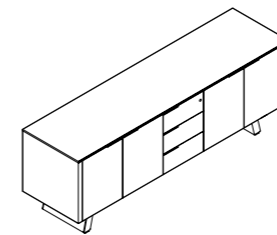

credenze · sideboards · dessert
glauben · geloof · creencia

216 x 57,4 x 75 cm

54/55

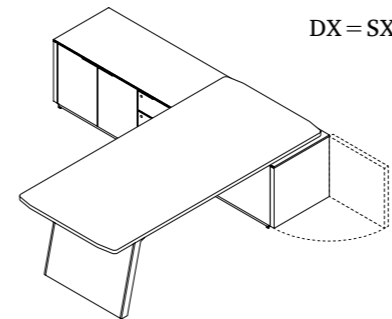

scrivania in legno · wooden desk
bureaux en bois · holzschreibtische
houten bureaus · escritorio de madera

L x P x H

240 x 100 x 75 cm

moduli di servizio · service modules
elements de service · multifunktionscontainer
servicemodulen · elementos de servicio

229 x 57,4 x 58,3 cm

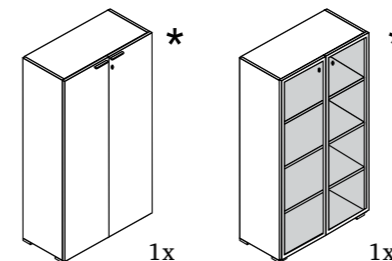

armadi · cabinets · armoires
Schränke · kasten · armarios

100 x 46 x 155,6 cm

I fianchi e i top sono obbligatori *indicazioni tecniche a pag. 63 · Closing sides and tops are compulsory *see technical info on p. 63 · Les côtés de fermeture et les tops sont obligatoires *voyez les informations techniques sur p. 63 · Ein Paar Seitenverkleidungen und eine Schrankabdeckplatte sind obligatorisch *siehe technische Informationen über p. 63 · De verplichte en de toppen zijn verplicht *zie technische info op p. 63 · Los par de costados y las tapas son obligatorios *ver información técnica en la pág. 63

metar

finishes

legni

woods · bois · holz · hout · maderá



rovere grigio
grey oak
chêne gris
Eiche grau
grijs eiken
roble gris

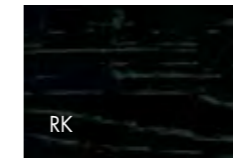

rovere laccato nero
black lacquered oak
chêne laqué noir
schwarz lackierter Eiche
zwart gelakt eiken
roble lacado negro



rovere naturale
natural oak
chêne naturel
Natur Eiche
eikenhout natuur
roble natural

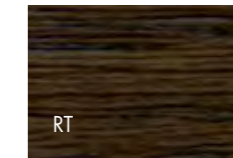

rovere tabacco
tobacco oak
chêne tabac
Eiche Tabak
eikenhout tabak
roble tabaco



rovere laccato bianco
white lacquered oak
chêne laqué blanc
weiß lackierter Eiche
wit gelakt eiken
roble lacado blanco

laccati lucidi

glossy lacquered · lacqué brilliant · glänzende lackiert · glanzend gelakt · laqueado pulido

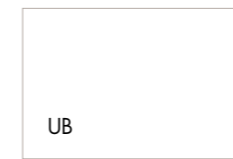

bianco
white
blanc
Weiß
wit
blanco

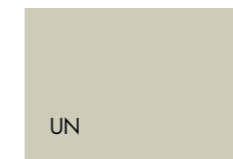

nebbia
mist
brouillard
Nebelgrau
mist
niebla

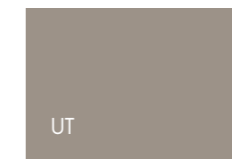

tortora
turtledove
tourterelle
Turteltaube
tortelduif
tórtola

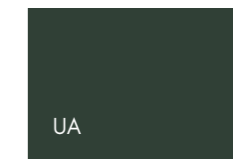

titanio
titanium
titane
Titan
titanium
titanio

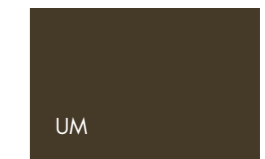

moka
moka
moka
Moka
moka
moka

ante vetro retrolaccato

colored glass doors · portes en verre laqué · umseitige lackierte glastüren
deuren gelakt glas · puertas de vidrio retro-lacado

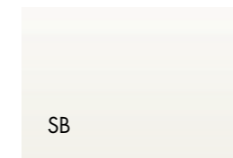

bianco
white
blanc
Weiß
wit
blanco



nero
black
noir
Schwarz
zwart
negro

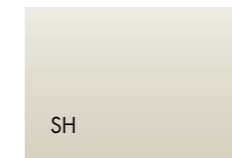

nebbia
mist
brouillard
Nebelgrau
mist
niebla

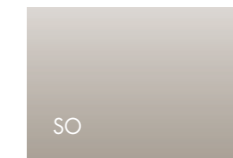

tortora
turtledove
tourterelle
Turteltaube
tortelduif
tórtola

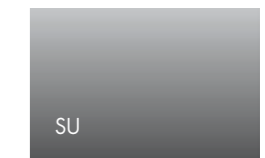

titanio
titanium
titane
Titan
titanium
titanio

ante vetro · parti metalliche · scocche armadi

glass doors · portes en verre · türen glas · glazen deurtjes · puertas de vidrio
metal parts · pièces métalliques · metallteile · metalen onderdelen · piezas de metal
cabinets frames · armoires coque · schränke korpusse · kasten structuur · estructura armarios

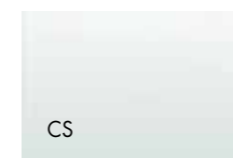

bi-satinato
frosted on both side
satiné sur le 2 faces
beidseitig satiniertes
tweezijding gesatineers
bi-satinado

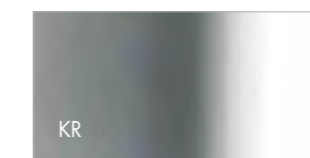

cromo lucido
glossy chrome
chromé brillant
Chrom poliert
glanzend verchromd
cromo pulido



laccato nero lucido
gloss black lacquered
laqué noir brillant
glänzend Schwarz lackiert
zwart Glanzend gelakt
laqueado negro pulido

metar

technical info

scrivania in legno · wooden desk · bureaux en bois · holz-schreibtische · houten bureaus · escritorio de madera L x P x H

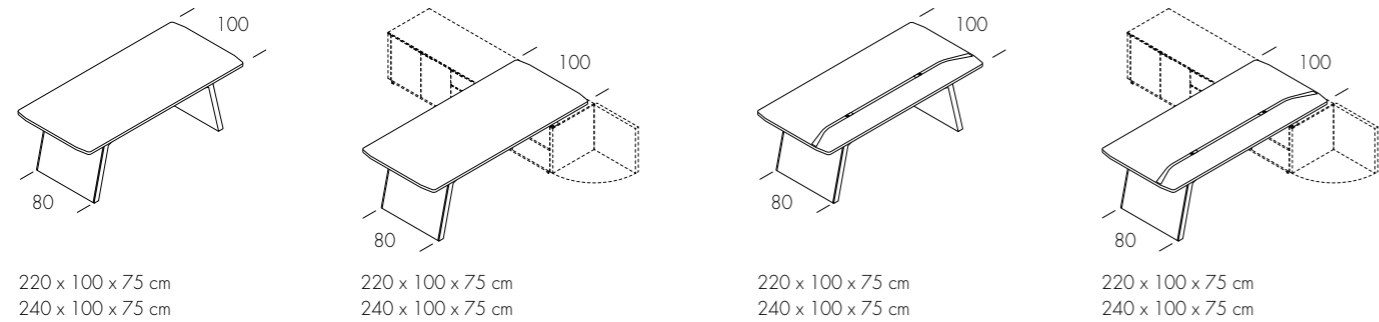

pannello modesty · modesty panel · voile de fond · knieraublended · bureauborden · panela para escritorio L x T x H

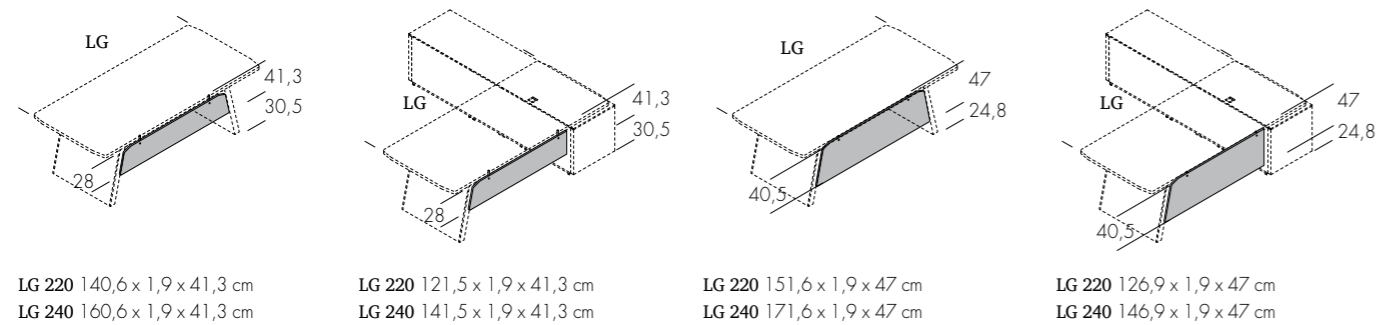

moduli di servizio · service modules · elements de service · multifunktionscontainer · servicemodulen · elementos de servicio L x P x H

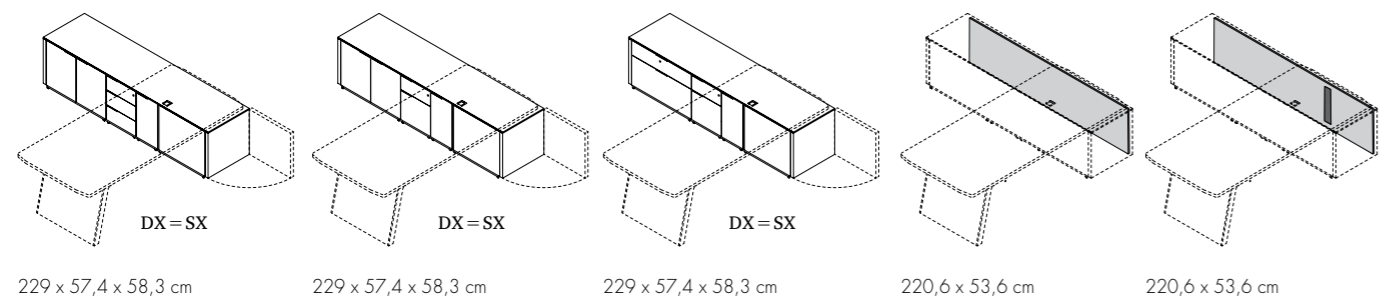

moduli di servizio · service modules · elements de service · multifunktionscontainer · servicemodulen · elementos de servicio L x P x H
credenze · sideboards · croyances · glauben · geloof · creencia

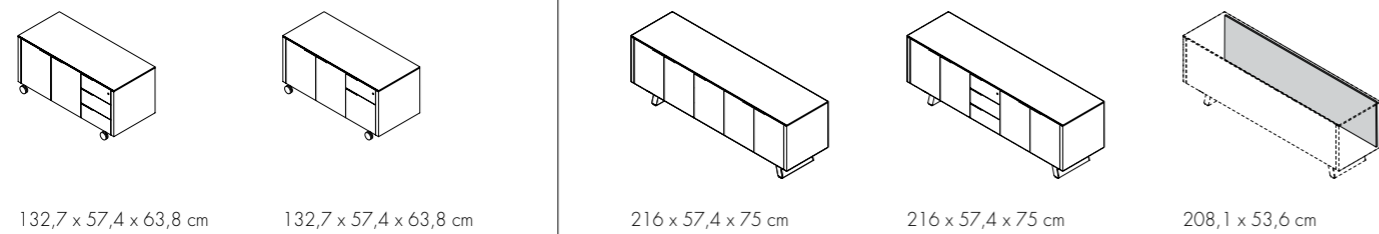

armadi · cabinets · armoires · Schränke · kasten · armarios L x H

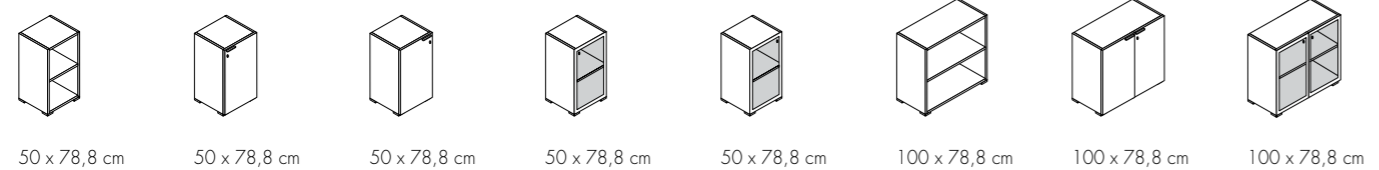

armadi · cabinets · armoires · Schränke · kasten · armarios L x H

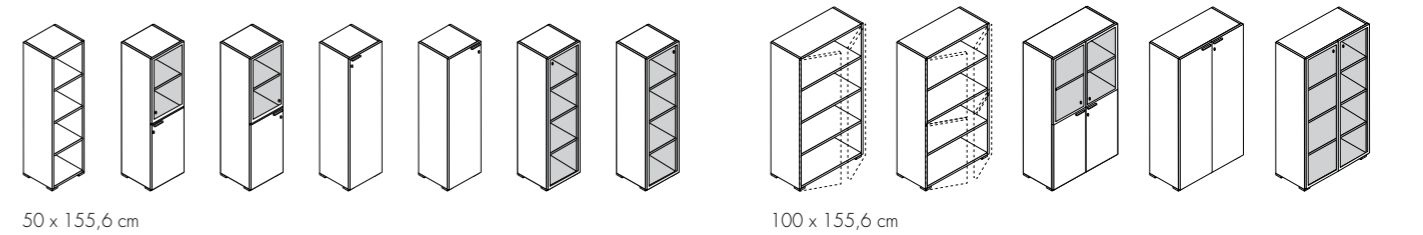

armadi · cabinets · armoires · Schränke · kasten · armarios L x H
fianchi di chiusura · closing sides · flancs de finition · abschlussflanken · zupanelen · costados de cierre

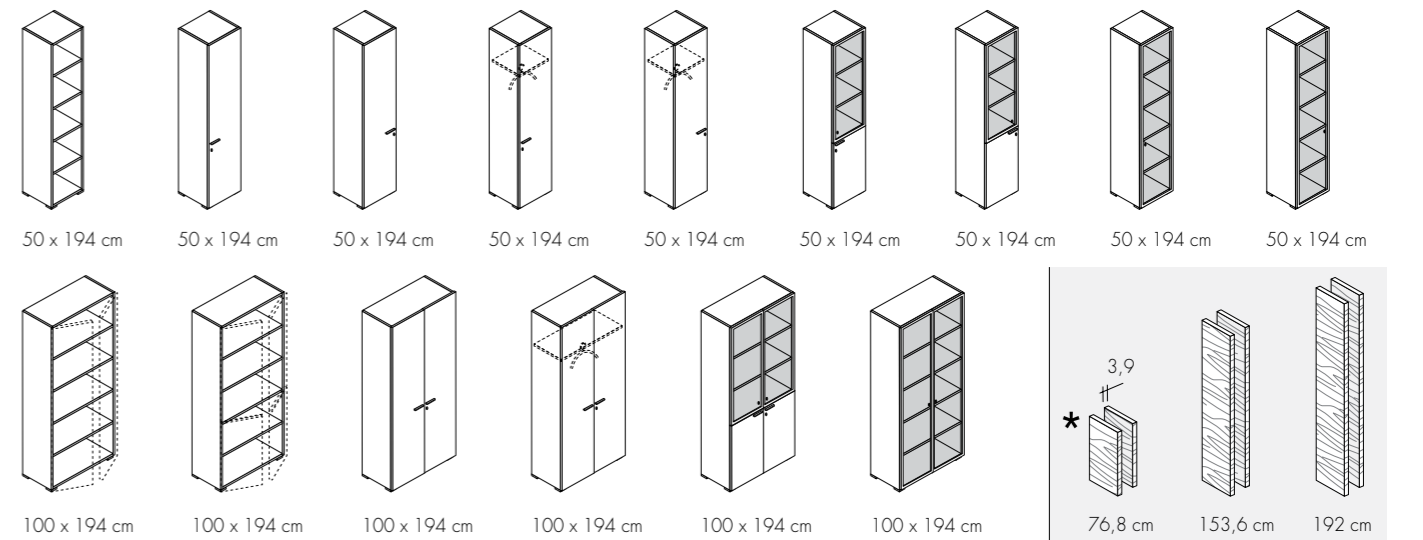

top · top · top · abdeckplatte · topblad · parte superior L x T

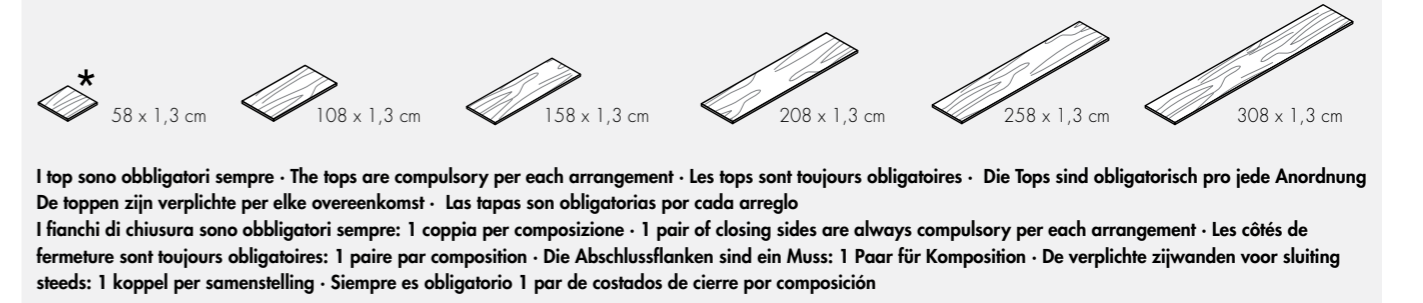

piano conversazione · conversation top · plan conversation · platte für gesprächstisch · conferentiebladen · plano de conversación
cestelli portacavi · cables holder baskets · bac porte-cables · kabel halterkörbchen · korfjes voor el. bedrading · cestos portables
tavoli riunione · meeting tables · tables de reunion · konferenztische · conferentietafel · mesas reuniones
tavolino da caffè · coffee table · table basse · couchtisch · salontafel · mesita para cortado L x P x H

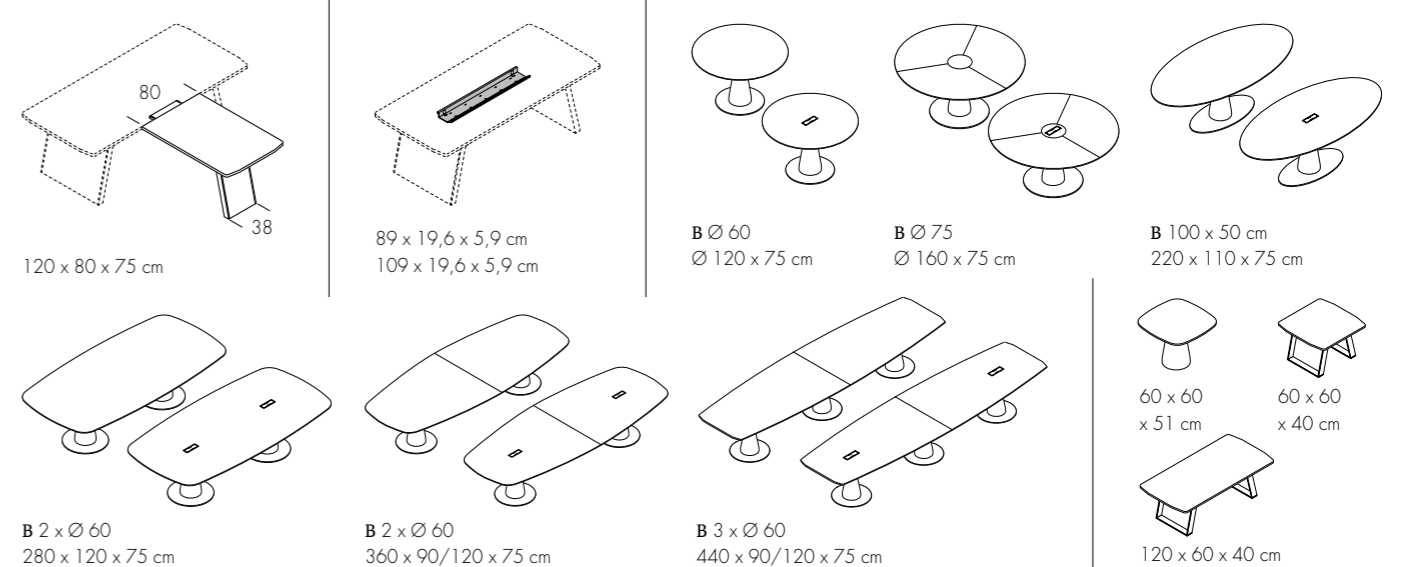

rail

creativity,
function
& prestige



_Le linee pure ed essenziali di Rail non impongono nessuna gerarchia sociale, ma comunicano status in virtù di una eleganza formale che appare in tutta la sua forte evidenza.

_Rail's pure and essential features do not establish any social hierarchy: instead, they exude a sense of status through the formal elegance that appears in all its relevance.

_Les lignes pures et essentielles de Rail n'imposent aucune hiérarchie sociale, mais communiquent un statut en vertu d'une élégance formelle qui apparaît dans toute son évidence.

_Die reinen und essentiellen Linien von Rail legen keine soziale Hierarchie auf, kommunizieren jedoch Status, dank einer ausprägenden formalen Eleganz.

_De zuivere en essentiële lijnen van Rail leggen geen sociale hiërarchie op, maar brengen status over op grond van een duidelijke formele elegantie.

_Las líneas puras y esenciales de Rail no imponen ninguna jerarquía social, pero comunican estatus en virtud de una elegancia formal que se manifiesta en toda su fuerte evidencia.

*rovere naturale, vetro trasparente
e acciaio cromato lucido.*

*natural oak wood, clear glass
and polished chrome-plated steel.*

*chêne rouvre naturel, verre transparent
et acier chromé brillant.*

*Eiche natur, transparentes Glas
und Edelstahl blank verchromt.*

*natureik, transparant glas
en glanzend verchromd staal.*

*roble natural, cristal transparente
y acero cromado brillante.*

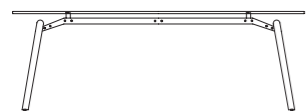

scrivania in vetro · glass desk
bureau en verre · Schreibtisch aus Glas
bureau in glas · escritorio de cristal

240 x 100 x 75 cm
94 1/2" x 39 1/4" x 29 1/2" in

rovere naturale, laccato bianco,
vetroceramica: grigio Stone opaco
e acciaio cromato lucido

natural oak wood, white veneer,
glass ceramic: Stone grey matt and
polished chrome-plated steel

chêne rouvre naturel, laqué blanc,
vitrocéramique: gris mat Stone et
acier chromé brillant

Eiche natur, weiß lackiert,
Glaskeramik: Grau matt Stone und
Edelstahl blank verchromt

natuureik, gelakt wit,
vitrokeramisch: grijs Stone mat en
glanzend verchromd staal

roble natural, lacado blanco,
vetroceramica: gris mate stone y
acero cromado brillante



*rovere bianco, laccato titanio,
vetroceramica: bianco
Calacatta lucido e acciaio
cromato lucido*

*white oak wood, titanium-
coloured veneer, glass
ceramic: glossy white
Calacatta and polished
chrome-plated steel*

*chêne rouvre blanc, laqué
titane, vitroceramique: blanc
brillant Calacatta
et acier chromé brillant*

*Eiche weiß, titan lackiert,
Glaskeramik: Weiß glänzend
Calacatta und Edelstahl blank
verchromt*

*witte eik, gelakt titanium,
vitrokeramisch: Glanzend
wit Calacatta en glanzend
verchromd staal*

*roble blanco, lacado titanio,
vetroceramica: Calacatta
blanco brillo y acero cromado
brillante*



rovere naturale, laccato bianco,
acciaio laccato nero opaco
e acciaio cromato lucido_

natural oak wood, white veneer,
matt black lacquered steel and
polished chrome-plated steel_

chêne rouvre naturel, laqué
blanc, acier laqué noir mat
et acier chromé brillant_

Eiche natur, weiß lackiert, Edelstahl
mattschwarz lackiert und Edelstahl
blank verchromt_

natuureik, gelakt wit, gelakt
matzwart staal en glanzend
verchromd staal_

roble natural, lacado blanco,
acero lacado negro mate
y acero cromado brillante_



rail

functionality style & color

_Il colore entra in ufficio e rende vivo e informale l'ambiente di lavoro. Questa combinazione cromatica è solo un suggerimento: nella gamma delle finiture Rail si possono individuare soluzioni molto personali ed originali.

_Colours permeate the office making the working space vibrant and informal. This colour scheme is just a suggestion: using the finishes of the Rail range, we're able to create different customized and original solutions.

_La couleur pénètre dans le bureau en rendant le lieu de travail vivant et informel. Cette combinaison chromatique n'est qu'une suggestion : il est possible de trouver des solutions très personnelles et originales dans la gamme de finitions Rail.

_Die Farbe dringt im Büro ein und macht das Arbeitsumfeld lebhaft und informell. Diese Farbkombination ist nur ein Vorschlag: In der Auswahl der Rail-Varianten werden zahlreiche persönliche und originale Lösungen angeboten.

_Kantoren worden kleurrijk, waardoor de werkomgeving levendiger en informeler wordt. Deze kleurencombinatie is slechts een suggestie: het assortiment afwerkingen van Rail bevat tal van persoonlijke en originele oplossingen.

_El color entra en la oficina y anima con un toque informal el ambiente de trabajo. Esta combinación cromática es solo una sugerencia: en la gama de los acabados Rail se pueden definir soluciones altamente personales y originales.

rovere naturale, laccato bordeaux, laccato titanio, acciaio laccato nero opaco e acciaio cromato lucido

natural oak wood, burgundy veneer, titanium-coloured veneer, matt black lacquered steel and polished chrome-plated steel

chêne rouvre naturel, laqué bordeaux, laqué titane, acier laqué noir mat et acier chromé brillant

Eiche natur, bordeauxrot lackiert, titan lackiert, Edelstahl mattschwarz lackiert und Edelstahl blank verchromt

natuureik, gelakt bordeaux, gelakt titanium, gelakt matzwart staal en glanzend verchromd staal

roble natural, lacado burdeos, lacado titanio, acero lacado negro mate y acero cromado brillante



rail

freestanding
desk



rovere tabacco, laccato nebbia
e acciaio cromato lucido

tobacco coloured oak wood, dark
white veneer and polished chrome-
plated steel

chêne rouvre tabac, laqué brume
et acier chromé brillant

Eiche tabak, nebel lackier
und Edelstahl blank verchromt

tabak eik, gelak mist
en glanzend verchroomd staal

roble tabaco, lacado niebla
y acero cromado brillante



rail

formal
elegance

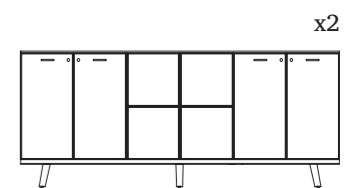

credenza · cabinet · armoire basse
Anrichte · kast · aparador

240 x 40 x 102 cm
94 1/2" x 15 3/4" x 40" in

rovere tabacco, laccato verde muschio,
acciaio laccato nero opaco e acciaio
cromato lucido; piano meeting
in ecopelle titanio e rovere tabacco.

tobacco coloured oak wood, moss green
veneer, matt black lacquered steel and
polished chrome-plated steel; conference
tabletop made of titanium-coloured eco-
leather and tobacco coloured oak wood.

chêne rouvre tabac, laqué vert mousse,
acier laqué noir mat et acier chromé
brillant; plateau pour réunion en cuir
écologique titane et chêne rouvre tabac.

Eiche tabak, moosgrün lackiert, Edelstahl
mattschwarz lackiert und Edelstahl blank
verchrom; Konferenztischplatte aus
Ecopell-Leder und Eiche tabak.

tabakskleurige eik, gelakt mosgroen,
gelakt matzwart staal en glanzend
verchromd staal; vergaderblad in
titanium kunstleer en tabakskleurige eik.

roble tabaco, lacado verde musgo, acero
lacado negro mate y acero cromado
brillante; sobre de mesa de reuniones de
ecopiel titanio y roble tabaco.



rail

composition elements & dimensions

08/09 10/11

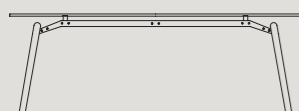

scrivania in vetro · glass desk
bureau en verre · Schreibtisch aus Glas
bureau in glas · escritorio de cristal

L x P x H

220 x 100 x 75 cm
86 3/4" x 39 1/4" x 29 1/2" in

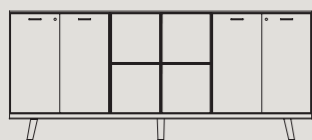

credenza · cabinet · armoire basse
Anrichte · kast · aparador

240 x 40 x 102 cm
94 1/2" x 15 3/4" x 40" in



modulo di servizio vetro · glass service
cabinet · desserte verre · Glas-Modul glazen
component · módulo de servicio cristal

80 x 40 x 75 cm
31 1/2" x 15 3/4" x 29 1/2" in



tavolino da caffè · coffee table
table basse · Kaffeetisch
koffietafelije · mesita de café

120 x 60 x 40 cm
47 1/4" x 23 3/4" x 15 3/4" in

12/13 14/15

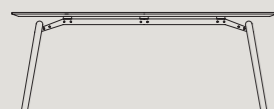

scrivania in legno · wooden desk
bureau en bois · Schreibtisch aus Holz
bureau in hout · escritorio de madera

L x P x H

220 x 100 x 75 cm
200 x 100 x 75 cm
86 3/4" x 39 1/4" x 29 1/2" in
78 3/4" x 39 1/4" x 29 1/2" in



credenza · cabinet · armoire basse
Anrichte · kast · aparador

200 x 40 x 102 cm
78 3/4" x 15 3/4" x 40" in



modulo di servizio legno · wooden service
cabinet · desserte bois · Modul aus Holz
houten component · módulo de servicio
madera

120 x 40 x 75 cm
47 1/4" x 15 3/4" x 29 1/2" in

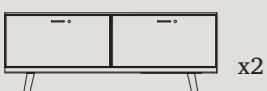

credenza · cabinet · armoire basse
Anrichte · kast · aparador

160 x 40 x 62 cm
63" x 15 3/4" x 24 1/2" in

> 12/13 14/15



tavolo riunione in legno · wooden
conference table · table de réunion en
bois · Konferenztisch aus Holz
vergadertafel in hout · mesa de reuniones
de madera

L x P x H

120 x 120 x 75 cm
47 1/4" x 47 1/4" x 29 1/2" in

18/19

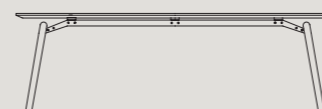

scrivania in legno · wooden desk
bureau en bois · Schreibtisch aus Holz
bureau in hout · escritorio de madera

L x P x H

240 x 100 x 75 cm
94 1/2" x 39 1/4" x 29 1/2" in

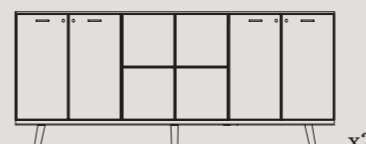

credenza · cabinet · armoire basse
Anrichte · kast · aparador

240 x 40 x 102 cm
94 1/2" x 15 3/4" x 40" in



modulo di servizio legno · wooden service
cabinet · desserte bois · Modul aus Holz
houten component · módulo de servicio
madera

120 x 40 x 75 cm
47 1/4" x 15 3/4" x 29 1/2" in

22/23

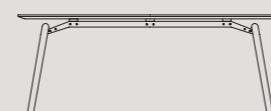

scrivania in legno · wooden desk
bureau en bois · Schreibtisch aus Holz
bureau in hout · escritorio de madera

L x P x H

200 x 100 x 75 cm
78 3/4" x 39 1/4" x 29 1/2" in

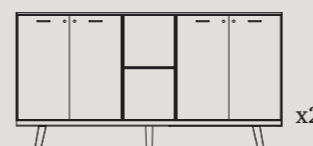

credenza · cabinet · armoire basse
Anrichte · kast · aparador

200 x 40 x 102 cm
78 3/4" x 15 3/4" x 40" in



modulo di servizio legno · wooden service
cabinet · desserte bois · Modul aus Holz
houten component · módulo de servicio
madera

80 x 40 x 75 cm
31 1/2" x 15 3/4" x 29 1/2" in



tavolo riunione in legno · wooden
conference table · table de réunion en bois
Konferenztisch aus Holz · vergadertafel in
hout · mesa de reuniones de madera

160 x 160 x 75 cm
63" x 63" x 29 1/2" in

rail

desk with structural
cabinet



rovere naturale, laccato bianco,
vetro trasparente e acciaio
cromato lucido_

natural lacquered oak, white
veneer, clear glass and polished
chrome-plated steel_

chêne rouvre naturel, laqué
blanc, verre transparent et
acier chromé brillant_

Eiche natur, weiß lackiert,
transparentes Glas und Edelstahl
blank verchromt_

natuureik, gelakt wit,
transparent glas en glanzend
verchromd staal_

roble natural, lacado blanco,
cristal transparente y acero
cromado brillante_



rovere bianco, laccato bianco
e acciaio laccato nero opaco;
piano meeting in ecopelle titanio
e rovere bianco_

natural lacquered oak, white veneer
and matt black lacquered steel
conference table made of titanium-
coloured eco-leather and white oak wood_

chêne rouvre blanc, laqué blanc
et acier laqué noir mat ;
plateau pour réunion en cuir écologique
titane et chêne rouvre blanc_

Eiche weiß, weiß lackiert und
Edelstahl mattschwarz lackiert;
Konferenztischplatte aus Ecopell-
Leder titan und Eiche weiß_

wit eiken, gelakt wit, en gelakt
matzwart staal; vergaderblad in
titanium kunstleder en witte eik_

roble blanco, lacado blanco y acero
lacado negro mate; sobre de mesa de
reuniones de ecopiel titanio y roble
blanco_



rail

*rovere naturale, vetro trasparente,
laccato tortora e acciaio cromato
lucido.*

*natural oak wood, clear glass,
dove-grey veneer and polished
chrome-plated steel.*

*chêne rouvre naturel, verre
transparent, laqué gris tourterelle
et acier chromé brillant.*

*Eiche natur, transparentes Glas,
taubengrau lackiert und Edelstahl
blank verchromt.*

*natuureik, transparant glas, gelakt
duifgrijs en glanzend verchromd
staal.*

*roble natural, cristal transparente,
lacado gris ceniciento y acero
cromado brillante.*



rovere tabacco, vetro trasparente,
laccato giallo gold e acciaio
cromato lucido_

tobacco coloured oak wood, clear
glass, gold-yellow veneer and
polished chrome-plated steel_

chêne rouvre tabac, verre
transparent, laqué jaune or et
acier chromé brillant_

Eiche tabak, transparentes Glas,
gold-gelb lackiert und Edelstahl
blank verchromt_

tabakskleurige eik, transparant
glas, gelakt goudgeel en
glanzend verchromd staal_

roble tabaco, cristal
transparente, lacado amarillo
gold y acero cromado brillante_



rail

strong & slight

_Questa immagine mostra lo slancio estetico che caratterizza Rail. Le travi in acciaio cromato lucido e con l'anima in legno a vista, sostengono la trasparente leggerezza del piano in vetro.

_This image shows Rail's aesthetic design. The polished chrome-plated pedestals with the wooden core in view support the clear lightness of the glass top.

_Cette image montre l'élan esthétique caractérisant Rail. Les poutres en acier chromé brillant dont l'âme en bois est apparente supportent la légèreté transparente du plateau en verre.

_Dieses Bild bezeugt den ästhetischen Elan, wodurch Rail gekennzeichnet wird. Die blank verchromte Edelstahlträger und das sichtbare hölzerne Innere unterstützen die transparente Leichtigkeit der gläsernen Tischplatte.

_Deze afbeelding toont de gestroomlijnde elegantie die kenmerkend is voor Rail. De staven in glanzend verchromd staal en het centrale gedeelte in zichtbaar hout ondersteunen de transparante lichtheid van het glazen blad.

_Esta imagen muestra la típica esbeltez estética de Rail. Las vigas de acero cromado brillante con alma de madera a la vista sostienen la transparente ligereza del sobre de cristal.



rovere tabacco, laccato
tortora e vetroceramica:
nero Marquinia opaco_

tobacco oak wood, dove-grey
veneer and glass ceramic:
Marquinia black matt_

chêne rouvre tabac,laqué
tourterelle et vitroceramique:
noir mat Marquinia_

Eiche tabak, taubengrau lackiert
Und glaskeramik: Schwarz
matt Marquinia_

tabakskleurige eik, duifgrijs
gelakt en vitrokeramisch:
zwart Marquinia mat_

roble tabaco,lacado gris
zeniciente y vitroceramica:
Marquina negro mate_



rail

respect of privacy

_In evidenza la naturalità del vero legno e la particolare lavorazione a "diamante" del piano; sottile sul bordo e più spesso verso il centro per suggerire una idea di estrema leggerezza e slancio. Il modesty panel, anch'esso sagomato, offre un alto grado di privacy.

_The naturalness of real wood and the special "diamond" pattern of the top are highlighted in this image; the structure is thinner on the edge and thicker on the centre, to evoke a light and slender feel. The patterned modesty panel offers a high level of privacy.

_La naturalité du bois véritable et le traitement particulier en « diamant » du plateau sont mis en évidence ; mince sur le bord et plus épais vers le centre afin de suggérer une idée de légèreté extrême et d'élan. La voile de fond, elle aussi profilée, offre une grande intimité.

_Bemerkenswert und auffallend ist die Natürlichkeit des authentischen Holzes und die besondere facettierte Bearbeitung der Tischplatte; Dünn am Rand und dicker in der Mitte um extreme Leichtigkeit auszudrücken. Das Modesty Paneel, auch geformt, garantiert ein hohes Maß an Privacy.

_De natuurlijke eigenschappen van het hout staan centraal, alsook de bijzondere "diamant"-achtige afwerking van het blad, dun aan de rand en dikker naar het midden toe, om buitengewone lichtheid en stroomlijning te suggereren. Het knieschot garandeert een hoge vorm van privacy.

_En primer plano la naturalidad de la madera auténtica y la manufactura diamantada del sobre; fino en el canto y más grueso hacia el centro para sugerir una idea de extraordinaria ligereza y estilización. El panel de protección, también perfilado, ofrece un alto nivel de privacidad.



rail

desk with structural
cabinet



rovere nero, laccato titanio, vetro
trasparente e acciaio cromato
lucido_

black oak wood, titanium-coloured
veneer, clear glass and polished
chrome-plated steel_

chêne rouvre noir, laqué titane,
verre transparent et acier chromé
brillant_

Eiche schwarz, titan lackiert,
transparentes Glas und Edelstahl
blank verchromt_

zwarte eik, gelakt titanium,
transparent glas en glanzend
verchromd staal_

roble negro, lacado titanio, cristal
transparente y acero cromado
brillante_



rail

qualities
sharing



rovere nero e laccato titanio_

*black oak wood and titanium-
coloured veneer_*

chêne rouvre noir et laqué titane_

Eiche schwarz und titan lackiert_

zwarte eik en gelakt titanium_

roble negro y lacado titanio_

rail

composition elements & dimensions

28/28 34/35

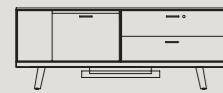
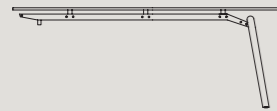

30/31

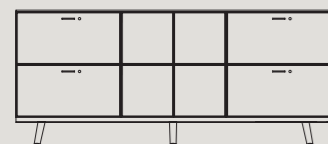
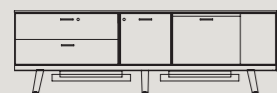
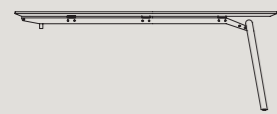

scrivania in vetro · glass desk
bureau en verre · Schreibtisch aus Glas
bureau in glas · escritorio de cristal

modulo di servizio · service cabinet
desserte · Modul · component
módulo de servicio

credenza · cabinet · armoire basse
Anrichte · kast · aparador

tavolo riunione in vetro · glassconference
table · table de réunion en verre
Konferenztisch aus Glas · vergadertafel in
glazen · mesa de reuniones de cristal

tavolino da caffè · coffee table
table basse · Kaffeetisch
koffietafeltje · mesita de café

L x P x H

200 x 100 x 75 cm
78 3/4" x 39 1/4" x 29 1/2" in

160 x 40 x 62 cm
63" x 15 3/4" x 24 1/2" in

200 x 40 x 102 cm
78 3/4" x 15 3/4" x 40" in

160 x 160 x 75 cm
63" x 63" x 29 1/2" in

120 x 60 x 40 cm
47 1/4" x 23 3/4" x 15 3/4" in

L x P x H

200 x 100 x 75 cm
78 3/4" x 39 1/4" x 29 1/2" in

200 x 40 x 62 cm
78 3/4" x 15 3/4" x 24 1/2" in

240 x 40 x 102 cm
94 1/2" x 15 3/4" x 40" in

179 x 172 x 75 cm
70 1/2" x 67 3/4" x 29 1/2" in

tavolo riunione in ecopelle · eco-leather
conference table · table de réunion en cuir
écologique · Konferenztisch aus Ecopell-Leder
vergadertafel in kunstleder · mesa de
reuniones de ecopiel

32/33

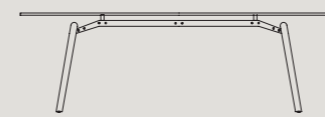
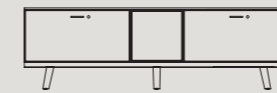
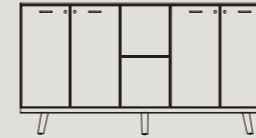
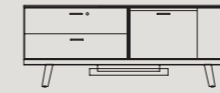

38/39

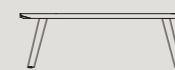
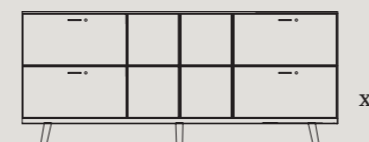
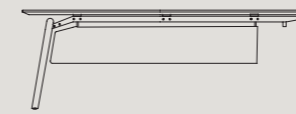

44/45 46/47

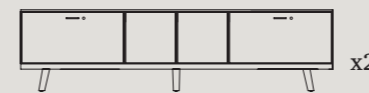
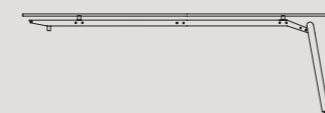

scrivania in vetro · glass desk
bureau en verre · Schreibtisch aus Glas
bureau in glas · escritorio de cristal

modulo di servizio · service cabinet
desserte · Modul · component
módulo de servicio

credenza · cabinet · armoire basse
Anrichte · kast · aparador

credenza · cabinet · armoire basse
Anrichte · kast · aparador

tavolo riunione in vetro · glassconference
table · table de réunion en verre
Konferenztisch aus Glas · vergadertafel in
glazen · mesa de reuniones de cristal

L x P x H

240 x 100 x 75 cm
94 1/2" x 39 1/4" x 29 1/2" in

160 x 40 x 62 cm
63" x 15 3/4" x 24 1/2" in

200 x 40 x 102 cm
78 3/4" x 15 3/4" x 40" in

200 x 40 x 62 cm
78 3/4" x 15 3/4" x 24 1/2" in

240 x 120 x 75 cm
94 1/2" x 47 1/4" x 29 1/2" in

L x P x H

220 x 100 x 75 cm
86 3/4" x 39 1/4" x 29 1/2" in

modulo di servizio · service cabinet
desserte · Modul · component
módulo de servicio

credenza · cabinet · armoire basse
Anrichte · kast · aparador

240 x 40 x 102 cm
94 1/2" x 15 3/4" x 40" in

tavolino da caffè · coffee table
table basse · Kaffeetisch
koffietafeltje · mesita de café

120 x 60 x 40 cm
47 1/4" x 23 3/4" x 15 3/4" in

scrivania in vetro/legno · glass/wooden
desk · bureau en verre/bois
Glas/holz-schreibtische · glas/houten
bureaus · escritorio de cristal/madera

modulo di servizio · service cabinet
desserte · Modul · component
módulo de servicio

credenza · cabinet · armoire basse
Anrichte · kast · aparador

L x P x H

240 x 100 x 75 cm
94 1/2" x 39 1/4" x 29 1/2" in

200 x 40 x 62 cm
78 3/4" x 15 3/4" x 24 1/2" in

200 x 40 x 62 cm
78 3/4" x 15 3/4" x 24 1/2" in

rail

ray
desk



rovere grigio, rovere grigio
e laccato bordeaux, laccato
tortora

grey oak wood, grey oak wood
and burgundy veneer, dove-grey
veneer

chêne rouvre gris, chêne rouvre
gris et laqué bordeaux, laqué
gris tourterelle

Eiche grau, Eiche grau
und bordeauxrot lackiert,
taubengrau lackiert

grijze eik, grijze eik en
gelakt bordeaux, gelakt
duifgrijs

roble gris, roble gris y
lacado burdeos, lacado gris
ceniciento

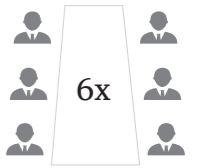

rail

meet, share, communicate

_La scrivania direzionale modifica il proprio ruolo adattandosi alle esigenze e permette di svolgere il lavoro individuale, ricevere ed accogliere, condividere e comunicare. Il mobile strutturale è già configurato per il passaggio cavi dal piano scrivania.

_The executive desk extends its functions by adapting to reception, sharing and communication needs. The furniture structure is already equipped with a grommet cable hole on the desktop.



_Le bureau de direction modifie son propre rôle en s'adaptant à l'exigence consistant à pouvoir recevoir et accueillir, partager et communiquer. Le meuble structural est déjà configuré pour le passage des câbles jusqu'au plateau du bureau.

_Der Direktionsschreibtisch ändert die eigene Funktion und richtet sich nach bestimmten Bedürfnissen: Empfangen, teilen und kommunizieren. Der Schrankunterbau ist schon für die Kabeldurchführung zur Schreibtischplatte konfiguriert.

_De directietafel wijzigt haar rol door zich aan te passen aan de behoeften om mensen te ontvangen, ervaringen te delen en te communiceren. De meubelstructuur is reeds voorzien voor het doorvoeren van de kabels naar het bureaublad.

_El escritorio de dirección modifica su rol para adaptarse a distintas necesidades: recibir y acoger, compartir y comunicar. El mueble estructural está configurado de modo que permite el paso de los cables al sobre del escritorio.

*rovere naturale
e laccato tortora*

*natural oak wood
and dove-grey veneer*

*chêne rouvre naturel
et laqué gris tourterelle*

*Eiche natur und
taubengrau lackiert*

*natuurlijk
en duifgrijs gelakt*

*roble natural
y lacado gris ceniciento*

Managerial

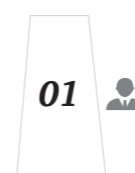

*Managerial
+ 1 - 2 guest*

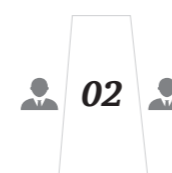

Meeting x3

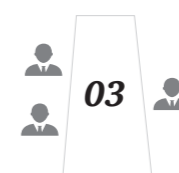

rail shape suggests function

La forma trapezoidale del piano assume un alto valore ergonomico quando, dal lavoro individuale, si desidera passare ad un meeting o al lavoro condiviso. Tutta la superficie è a disposizione e vi è un completo utilizzo dello spazio su tutti e tre i lati.

The trapezoidal shape of the top has a significant ergonomic value, allowing use for individual work or for meetings and shared work. The surface is entirely usable, as well as the space on all three sides.

rovere tabacco, laccato titanio, vetro trasparente e acciaio cromato lucido

tobacco coloured oak wood, titanium coloured veneer, clear glass and polished chrome-plated steel

chêne rouvre tabac, laqué titane, verre transparent et acier chromé brillant

Eiche tabak, titan lackiert, transparentes Glas und Edelstahl blank verchromt

tabakskleurige eik, gelakt titanium, transparant glas en glanzend verchromd staal

roble tabaco, lacado titanio, cristal transparente y acero cromado brillante

Managerial

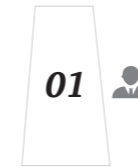

Managerial + 1 - 2 guest

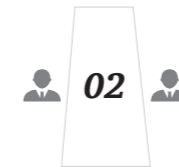

Meeting x3

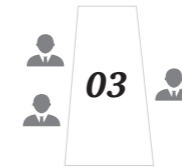

Meeting x6

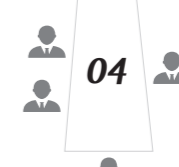

La forme trapézoïdale du plateau revêt une grande valeur ergonomique quand on souhaite passer du travail individuel à une réunion ou à un travail d'équipe. Toute la surface est disponible et il est possible d'utiliser tout l'espace sur les trois côtés.

Die trapezförmige Tischplatte hat ein hohes Maß an Ergonomie, da es einen Übergang von der Einzelarbeit zu einem Meeting oder zur Gruppenarbeit ermöglicht. Die ganze Oberfläche steht zur Verfügung und die vollständige Nutzung des Raumes ist auf allen drei Seiten ermöglicht.

Het trapeziumvormige blad is ergonomische erg nuttig wanneer u een individuele werkruimte wilt omvormen tot een vergader- of gedeelde ruimte. Het volledige oppervlak kan gebruikt worden; de ruimte kan aan de drie kanten volledig benut worden.

La forma trapezoidal del sobre asume un alto valor ergonómico cuando se desea pasar del trabajo individual a una reunión o al trabajo en equipo. Toda la superficie permanece disponible y el espacio se utiliza completamente en los tres lados.



rail

composition elements & dimensions

52/53



scrivania in legno · wooden desk
bureau en bois · holz-schreibtische
houten bureaus · escritorio de madera

L x P x H

220 x 110 x 75 cm
86 3/4" x 43 1/4" x 29 1/2" in

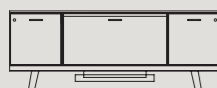

modulo di servizio · service cabinet
desserte · Modul · component
módulo de servicio

160 x 40 x 62 cm
63" x 15 3/4" x 24 1/2" in



credenza · cabinet · armoire basse
Anrichte · kast · aparador

240 x 40 x 102 cm
94 1/2" x 15 3/4" x 40" in

54/55

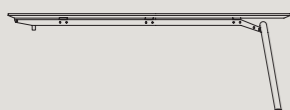

scrivania in legno · wooden desk
bureau en bois · holz-schreibtische
houten bureaus · escritorio de madera

L x P x H

220 x 110 x 75 cm
86 3/4" x 43 1/4" x 29 1/2" in



modulo di servizio · service cabinet
desserte · Modul · component
módulo de servicio

240 x 40 x 62 cm
94 1/2" x 15 3/4" x 24 1/2" in

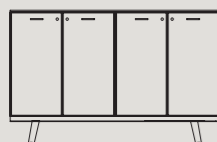

credenza · cabinet · armoire basse
Anrichte · kast · aparador

160 x 40 x 102 cm
63" x 15 3/4" x 40" in

56/57

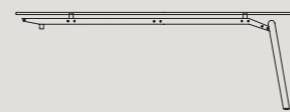

scrivania in vetro · glass desk
bureau en verre · Schreibtisch aus Glas
bureau in glas · escritorio de cristal

L x P x H

220 x 110 x 75 cm
86 3/4" x 43 1/4" x 29 1/2" in

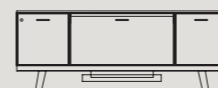

modulo di servizio · service cabinet
desserte · Modul · component
módulo de servicio

160 x 40 x 62 cm
63" x 15 3/4" x 24 1/2" in



credenza · cabinet · armoire basse
Anrichte · kast · aparador

240 x 40 x 102 cm
94 1/2" x 15 3/4" x 40" in

rail

delta
desk

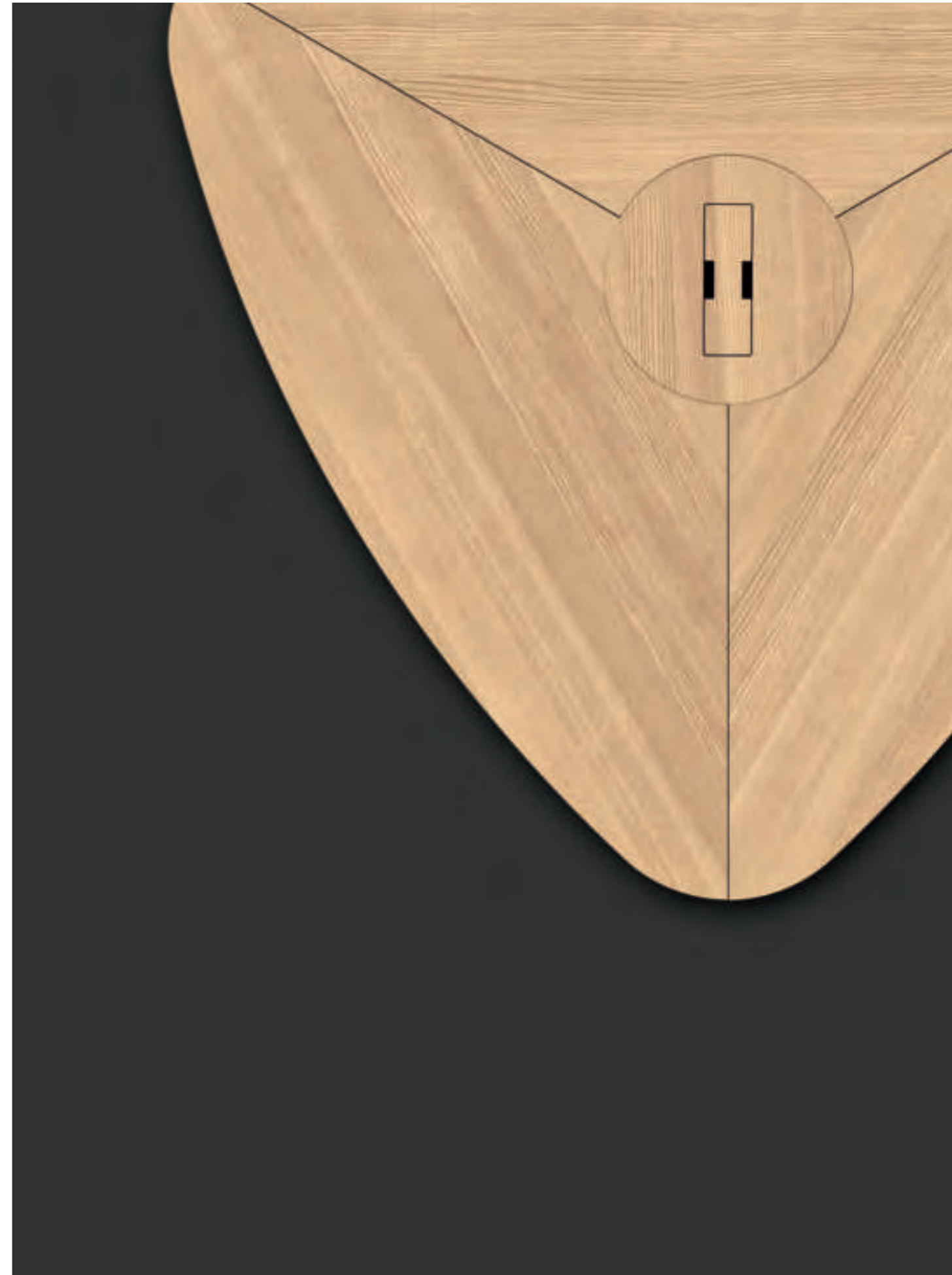

one desk four different uses

«L'organizzazione dello spazio, anche all'interno dell'ufficio direzionale, risponde a logiche di ottimizzazione e razionalizzazione facendo assumere, agli arredi, ruoli polivalenti. Anche in questo caso Rail si rivela innovativo perché, oltre a proporre una forma davvero funzionale, permette di utilizzare il piano sia come scrivania direzionale, oppure come tavolo meeting.

«The organization of space, even within the executive office, responds to optimization and rationalization logics, making the furniture more versatile. Even in this case, Rail is truly innovative, because, apart from featuring a highly functional shape, it allows to use the top as executive desk or as conference table.

«L'organisation de l'espace, même à l'intérieur du bureau de direction, répond à des logiques d'optimisation et de rationalisation en permettant aux meubles d'avoir des rôles polyvalents. Dans ce cas-là aussi, Rail s'avère innovant car, non seulement il propose une forme vraiment fonctionnelle, mais il permet également d'utiliser le plateau tant comme bureau de direction que comme table de réunion.

«Die Raumgestaltung, auch im Chefbüro, entspricht Rationalisierungs- und Optimierungsregeln und die Einrichtungen übernehmen vielfältige Funktionen. Auch in diesem Fall stellt sich Rail innovativ heraus, da es nicht nur eine extrem funktionelle Form darbietet, sondern auch ermöglicht, die Tischplatte als Direktionsschreibtisch oder auch als Konferenztisch zu benutzen.

«Ook in een directiekantoor dient de ruimtelijke organisatie voortdurende geoptimaliseerd te worden en zo rationeel mogelijk georganiseerd te worden. Hierdoor neemt het meubilair een polyvalente rol aan. Ook in dit geval blijkt Rail vernieuwend te zijn. Dankzij de uiterst functionele vorm van het blad kan de tafel zowel als directietafel als vergadertafel gebruikt worden.

«La organización del espacio responde a lógicas de optimización y racionalización que hacen que el mobiliario asuma roles polivalentes incluso en la oficina de dirección. También en este caso Rail demuestra un carácter innovador puesto que, además de proponer una forma realmente funcional, permite utilizar el sobre como escritorio de dirección o como mesa de reuniones.

«Le illustrazioni chiariscono, in modo efficace, la varietà di utilizzo del piano: da scrivania direzionale diventa perfetta per accogliere più ospiti, distribuendoli lungo il perimetro e mantenendo i ruoli, oppure prestandosi a un utilizzo intensivo come piano meeting. The images efficiently highlight the versatility of the top: from executive desk, it becomes a perfect table to accommodate several guests, by distributing them along the perimeter and maintaining the main hierarchical organization, or by becoming a perfect conference table. Les illustrations montrent de façon efficace la variété d'utilisation du plateau : de bureau de direction il devient parfait pour accueillir plusieurs personnes, en les distribuant le long de son périmètre et en conservant les rôles, ou bien en se prêtant à une utilisation intensive comme plateau de réunion. Die Bilder stellen die Vielfältigkeit der Tischplatte wirkungsvoll dar: Optimal als Direktionsschreibtisch, um mehrere Besucher zu empfangen, die in der gesamten Länge sitzen können und gleichzeitig jeweils die eigene Funktion aufrechterhalten, oder als Konferenztisch. De illustraties tonen op doeltreffende wijze de gebruiksverscheidenheid van het blad: een directietafel wordt omgevormd tot de perfecte omgeving om meerdere personen te ontvangen en ze naast elkaar in de lengte van de tafel te laten plaatsnemen en toch de functies te behouden, of verleent zich tot intensief gebruik als vergadertafel. Las ilustraciones aclaran eficazmente la variedad de uso del sobre: de escritorio de dirección se convierte en un elemento perfecto para acoger a varios invitados, distribuyéndolos a lo largo del perímetro y manteniendo los roles, o para un uso intensivo como mesa de reuniones.

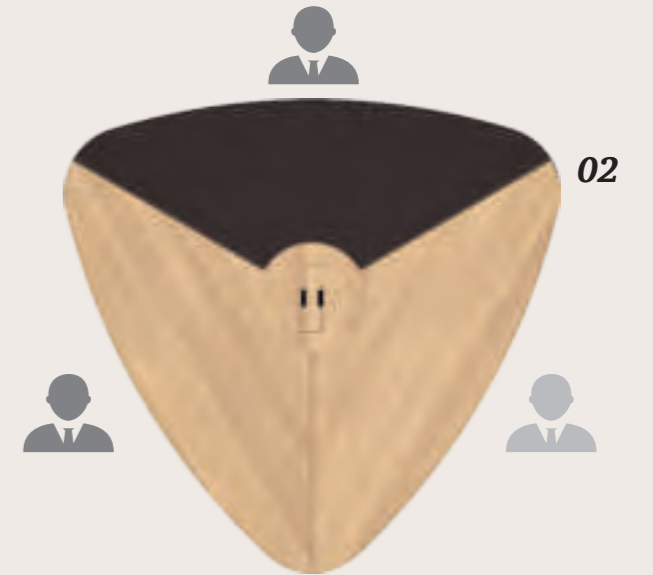
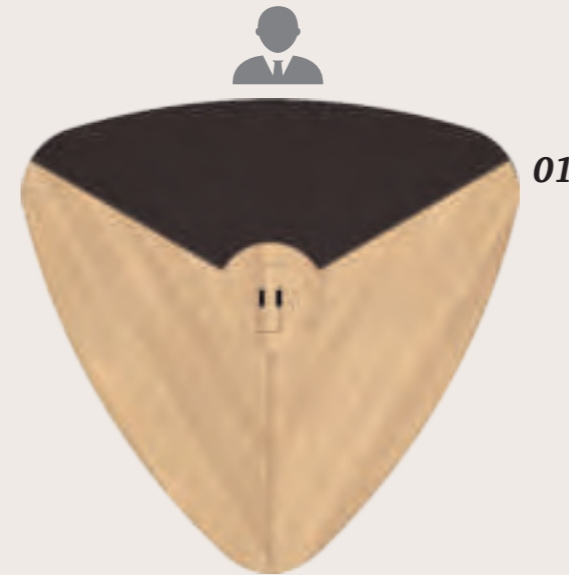

01 Managerial

02 Managerial + 1 - 2 guest

03 Meeting x3

04 Meeting x6



rail relationship

„In ufficio compaiono nuove forme che uniscono alla funzionalità, una ergonomia d'uso assolutamente innovativa. La forma del piano permette di svolgere diverse funzioni, dal lavoro manageriale al lavoro condiviso, sottolineando sempre i ruoli, grazie a uno studio spaziale attento alle relazioni e alle interazioni tra le persone.

„New shapes appear in the office, combining an innovative comfort of use to their functionality. A careful study of the spaces allows to maintain relationships and interactions, underlining the importance of the various roles.

„De nouvelles formes apparaissent au bureau et elles allient à la fonctionnalité une ergonomie d'utilisation totalement innovante. Une étude attentive des espaces permet de maintenir les rapports de relation et d'interaction sans oublier l'importance des rôles.

„Im Büro erscheinen neue Formen, die Funktionalität und eine völlig innovative Ergonomie verbinden. Eine genaue Raumplanung ermöglicht, Verhältnisse und Interaktion aufrecht zu erhalten, aber ohne die Wichtigkeit der einzelnen Rollen zu vergessen.

„In het kantoor verschijnen nieuwe vormen die functionaliteit combineren met een innoverende ergonomie. Een aandachtige bestudering van de ruimte maken gesprekken mogelijk zonder het belang van de rollen te vergeten.

„En la oficina aparecen nuevas formas que aúnan funcionalidad y una ergonomía de uso absolutamente innovadora. Un atento estudio de los espacios permite mantener las relaciones y la interacción personal sin olvidar la importancia de los roles.

*rovere bianco, piano
parzialmente rivestito
in ecopelle titanio*

*white oak wood, top
partially upholstered with
titanium-coloured eco-leather*

*chêne rouvre blanc,
plateau partiellement habillé
en cuir écologique titane*

*Eiche weiß, Tischplatte
zum Teil mit Ecopell-leder
titan überzogen*

*witte eik, blad gedeeltelijk
bekleed met titaniumkleurig
kunstleder*

*roble blanco, sobre
parcialmente revestido
en ecopiel titanio*



rail

personal
signature

*rovere naturale,
laccato deep teal*

*natural oak wood,
deep teal veneer*

*chêne rouvre naturel,
laqué bleu-vert foncé*

*Eiche natur,
deep teal lackiert*

*natureik,
gelakt deep teal*

*roble natural,
lacado deep teal*



rail meeting spaces

_Se la forma suggerisce la funzione, Rail presta le proprie linee a performances che rendono l'ufficio estremamente dinamico e flessibile.

_If form is the "how of the matter", Rail's features foster performances that make the office extremely dynamic and flexible.

_Si la forme suggère la fonction, Rail prête ses lignes à des performances qui rendent le bureau extrêmement dynamique et flexible.

_Jede Form deutet eine Funktion an und Rail garantiert immer mit ihren Linien Leistungen, die das Büro extrem dynamisch und flexibel machen.

_De vorm suggereert de functie. De lijnen van Rail zorgen voor een uiterst dynamisch en flexibel kantoor.

_Si la forma sugiere la función, no cabe duda de que Rail ofrece sus líneas a prestaciones que convierten a la oficina en un lugar extraordinariamente dinámico y flexible.

*rovere bianco
ed ecopelle titanio_*

*white oak wood
and titanium-coloured
eco-leather_*

*chêne rouvre blanc
et cuir écologique titane_*

*Eiche weiß
und Ecopell-Leder titan_*

*witte eik
en titaniumkleurig
kunstleder_*

*roble blanco
y ecopiel titanio_*



rail

desk or meeting?

_Quattro sono le configurazioni possibili: piano in vetro trasparente e struttura in una delle 5 diverse essenze in combinazione con l'acciaio cromato lucido, oppure con piano tutto legno, legno ed ecopelle in tre finiture o tutto ecopelle, sempre in tre nuance. Nelle versioni con piano legno o misto oppure tuttopelle, la struttura è sempre disponibile nelle cinque essenze abbinata all'acciaio laccato nero opaco.

_Four possible layouts: clear glass top and structure made of one of the five possible materials, combined with polished chrome-plated steel, or wooden top, wooden and eco-leather top with three different finishes or eco-leather top with three different nuances. In the wooden, mixed or leather top versions, the structure is available in five different materials, combined with matt black lacquered steel.

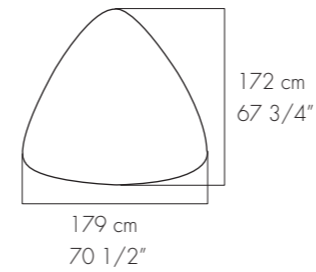

_Quatre configurations sont possibles : plateau en verre transparent et structure dans l'une des cinq différentes essences en combinaison avec l'acier chromé brillant, ou bien avec un plateau entièrement en bois, bois et cuir écologique dans trois finitions ou entièrement en cuir écologique, toujours dans trois nuances. Dans les versions avec un plateau en bois, mixte ou bien entièrement en cuir, la structure est toujours disponible dans les cinq essences associées à l'acier laqué noir mat.

_Er zijn vier configuraties beschikbaar: blad in transparant glas en structuur in een van de vijf verschillende combinaties met glanzend verchromd staal, of met het blad volledig in hout, hout en kunstleder in drie afwerkingen of volledig in kunstleder in drie afwerkingen. In de versies met een blad in hout, hout en leder of volledig in leder is de structuur altijd beschikbaar in de vijf kleuren, gecombineerd met matzwart gelakt staal.

_Es gibt vier mögliche Ausführungen: Tischplatte aus transparentem Glas und Struktur aus einer der fünf verschiedenen Holzarten kombiniert mit Edelstahl blank verchromt, oder mit Tischplatte komplett aus Holz, Holz und Ecopell-Leder in drei Varianten oder komplett aus Ecopell-Leder, immer in drei Nuancen. In den Ausführungen mit Tischplatte aus Holz oder kombiniert oder komplett aus Leder, ist die Struktur immer in den fünf Holztypen verfügbar, kombiniert mit Edelstahl mattschwarz lackiert.

_Las configuraciones posibles son cuatro: sobre de cristal transparente y estructura en una de las cinco distintas maderas en combinación con el acero cromado brillante, o bien con sobre completamente de madera, madera y ecopiel en tres acabados o todo ecopiel, siempre en tres tonalidades. En las versiones con sobre de madera, mixto o completamente de piel, la estructura está siempre disponible en las cinco maderas combinadas con el acero lacado negro mate.



vetro trasparente_
clear glass_
verre transparent_
transparentes Glas_
transparent glas_
cristal transparente_



tuttolegno_
wood_
entièrement en bois_
ganz aus Holz_
volledig hout_
todo madera_



legno ed ecopelle_
wood and eco-leather_
bois et cuir écologique_
Holz und Ecopell-Leder_
hout en kunstleder_
madera y ecopiel_



tutto ecopelle_
eco-leather_
entièrement en cuir écologique_
ganz aus Ecopell-Leder_
volledig kunstleder_
todo ecopiel_

rail

meeting
table

rovere tabacco, vetro
trasparente e acciaio
cromato lucido_

tobacco- coloured oak
wood, clear glass and
polished chrome-plated
steel_

chêne rouvre tabac,
verre transparent et
acier chromé brillant_

Eiche tabak,
transparentes Glas
und Edelstahl blank
verchromt_

tabakskleurige eik,
transparant glas en
glanzend verchromd
staal_

roble tabaco, cristal
transparente y acero
cromado brillante_

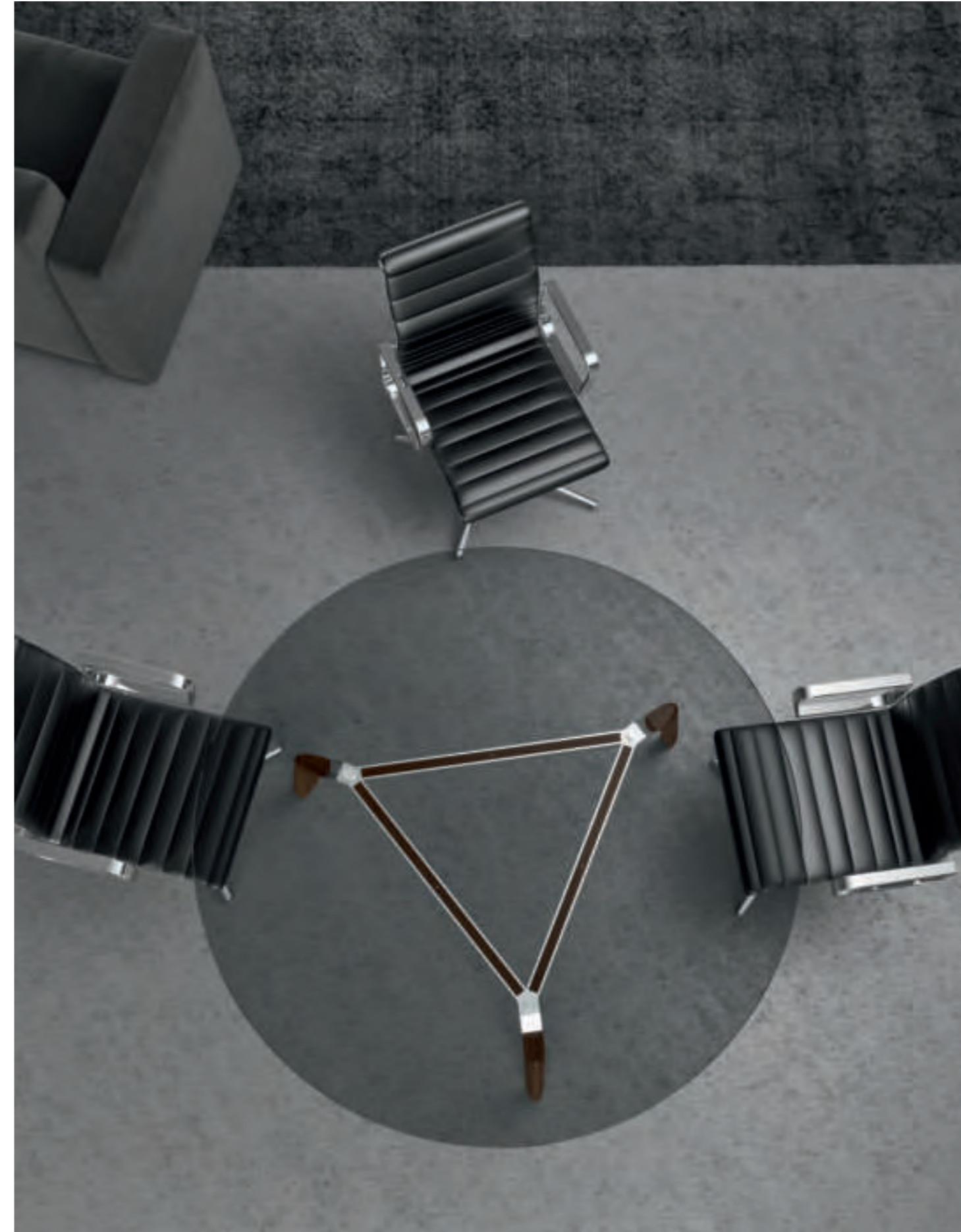

rovere naturale
e laccato bianco_

natural oak wood
and white veneer_

chêne rouvre naturel
et laqué blanc_

Eiche natur
und weiß lackiert_

natuureik en wit
gelakt_

roble natural
y lacado blanco_

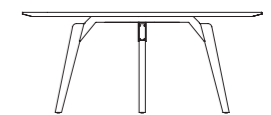
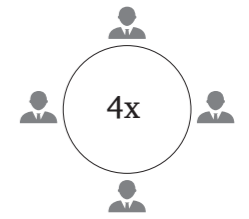

tavolo riunione · conference table
table de réunion · Konferenztisch
vergadertafel · mesa de reuniones

120 x 120 x 75 cm
47 1/4" x 47 1/4" x 29 1/2" in

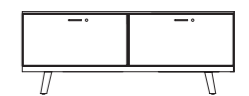

credenza · cabinet · armoire basse
Anrichte · kast · aparador

160 x 40 x 62 cm
63" x 15 3/4" x 24 1/2" in



*rovere naturale, vetro trasparente,
laccato tortora e acciaio cromato
lucido.*

*natural oak wood, clear glass, dove-
grey veneer and polished chrome-plated
steel.*

*chêne rouvre naturel, verre transparent,
laqué gris tourterelle et acier chromé
brillant.*

*Eiche natur, transparentes Glas,
taubengrau lackiert und Edelstahl
blank verchromt.*

*natuureik, transparant glas, duifgrijs
gelakt en glanzend verchromd staal.*

*roble natural, cristal transparente,
lacado gris ceniciento y acero cromado
brillante.*

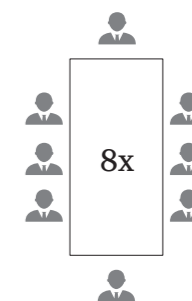

tavolo riunione · conference table
table de réunion · Konferenztisch
vergadertafel · mesa de reuniones

240 x 120 x 75 cm
94 1/2" x 47 1/4" x 29 1/2" in

rovere naturale
e laccato oceano_

natural oak wood
and ocean-blue veneer_

chêne rouvre naturel
et laqué océan_

Eiche natur
und ozean lackiert_

natuureik en
oceaankleurig gelakt_

roble natural
y lacado océano_

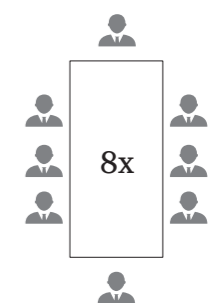

tavolo riunione · conference table
table de réunion · Konferenztisch
vergader tafel · mesa de reuniones

240 x 120 x 75 cm
94 1/2" x 47 1/4" x 29 1/2" in

rovere tabacco
e laccato nebbia,

tobacco coloured oak wood
and dark white veneer,

chêne rouvre tabac
et laqué brume,

Eiche tabak
und nebel lackiert,

tabakskleurige eik
en mistkleurig gelakt,

roble tabaco
y lacado niebla,



rail

composition elements & dimensions

73



tavolo riunione in vetro · glassconference table · table de réunion en verre
Konferenz Tisch aus Glas · vergadertafel in glazen · mesa de reuniones de cristal

L x P x H

160 x 160 x 75 cm
63" x 63" x 29 1/2" in

76/77

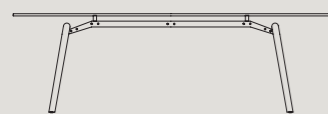

tavolo riunione in vetro · glassconference table · table de réunion en verre
Konferenz Tisch aus Glas · vergadertafel in glazen · mesa de reuniones de cristal

L x P x H

240 x 120 x 75 cm
94 1/2" x 47 1/4" x 29 1/2" in

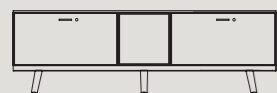

credenza · cabinet · armoire basse
Anrichte · kast · aparador

200 x 40 x 62 cm
78 3/4" x 15 3/4" x 24 1/2" in

78/79

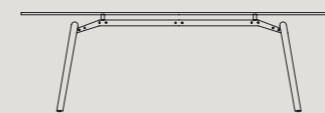

tavolo riunione in legno · woodconference table · table de réunion en bois
Konferenz Tisch aus Holz · vergadertafel in hout · mesa de reuniones de madera

L x P x H

240 x 120 x 75 cm
94 1/2" x 47 1/4" x 29 1/2" in



credenza · cabinet · armoire basse
Anrichte · kast · aparador

240 x 40 x 62 cm
94 1/2" x 15 3/4" x 24 1/2" in

80/81

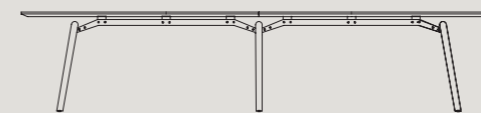

tavolo riunione in legno · wooden conference table · table de réunion en bois · Konferenz Tisch aus Holz
vergadertafel in hout · mesa de reuniones de madera

L x P x H

360 x 120 x 75 cm
141 3/4" x 47 1/4" x 29 1/2" in

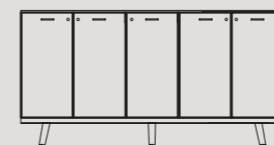

credenza · cabinet · armoire basse
Anrichte · kast · aparador

200 x 40 x 62 cm
78 3/4" x 15 3/4" x 24 1/2" in

rail

choose your style

_Rail offre una ampia opportunità di personalizzazione con numerose opzioni cromatiche; le cinque proposte di gambe in essenza sono combinabili con piani nella medesima finitura o in vetro trasparente.

_Rail offers several customization options and colours; the five leg options can be combined with tops with the same finish or clear glass tops.

_Rail offre une grande possibilité de personnalisation avec de nombreuses options chromatiques ; les cinq propositions de piétements en essence peuvent être combinées avec des plateaux dans la même finition ou en verre transparent.

_Rail bietet umfangreiche Personalisierungsmöglichkeiten und zahlreiche Farbkombinationen an; Die hölzernen Beine in fünf Varianten sind mit Tischplatte in designgleicher Gestaltung oder aus transparentem Glas kombinierbar.

_Rail biedt een uitgebreide mogelijkheid om de meubels te personaliseren met talrijke kleuren; de vijf verschillende poten kunnen gecombineerd worden met bladen met dezelfde afwerking of in transparant glas.

_Rail ofrece una amplia posibilidad de personalización con numerosas opciones cromáticas; las cinco propuestas de patas de madera pueden combinarse con sobres con el mismo acabado o de cristal transparente.



*rovere naturale_
natural oak wood_
chêne rouvre naturel_
Eiche natur_
natuureik_
roble natural_*

*rovere grigio_
grey oak wood_
chêne rouvre gris_
Eiche grau_
grijze eik_
roble gris_*

*rovere tabacco_
tobacco coloured
oak wood_
chêne rouvre tabac_
Eiche tabak_
tabakskleurige eik_
roble tabaco_*

*rovere nero_
black oak wood_
chêne rouvre noir_
Eiche schwarz_
zwarte eik_
roble negro_*

*rovere bianco_
white oak wood_
chêne rouvre blanc_
Eiche weiß_
witte eik_
roble blanco_*

rail

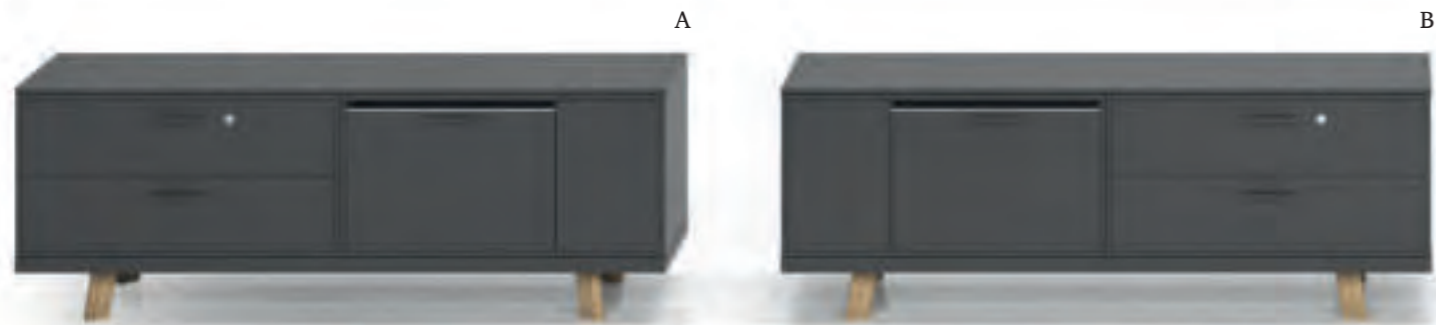

A_ 160 x 40 x 62 cm
63" x 15 3/4" x 24 1/2" in

B_ 160 x 40 x 62 cm
63" x 15 3/4" x 24 1/2" in

C_ 200 x 40 x 62 cm
78 3/4" x 15 3/4" x 24 1/2" in

D_ 200 x 40 x 62 cm
78 3/4" x 15 3/4" x 24 1/2" in

E_ 120 x 40 x 75 cm
47 1/4" x 15 3/4" x 29 1/2" in

F_ 80 x 40 x 75 cm
31 1/2" x 15 3/4" x 29 1/2" in

G_ 160 x 40 x 62 cm
63" x 15 3/4" x 24 1/2" in

H_ 120 x 40 x 75 cm
47 1/4" x 15 3/4" x 29 1/2" in



rail

I 240 x 40 x 102 cm
94 1/2" x 15 3/4" x 40" in
L 160 x 40 x 102 cm
63" x 15 3/4" x 40" in
M 200 x 40 x 102 cm
78 3/4" x 15 3/4" x 40" in
N 160 x 40 x 102 cm
63" x 15 3/4" x 40" in
O 240 x 40 x 102 cm
94 1/2" x 15 3/4" x 40" in

P 160 x 40 x 102 cm
63" x 15 3/4" x 40" in
Q 200 x 40 x 102 cm
78 3/4" x 15 3/4" x 40" in
R 240 x 40 x 102 cm
94 1/2" x 15 3/4" x 40" in
S 200 x 40 x 102 cm
78 3/4" x 15 3/4" x 40" in



rail

! *Le immagini delle pagine precedenti servono unicamente a rappresentare alcune possibilità dimensionali della gamma Rail. Per un approfondimento su misure, finiture e combinazioni cromatiche, si suggerisce di consultare il listino. The images featured in the previous pages merely suggest some of the several size options of the Rail range. For more information on sizes, finishes and colour schemes, see the price list. Les images des pages précédentes ne servent qu'à représenter certaines possibilités de dimensions de la gamme Rail. Pour approfondir les mesures, les finitions et les combinaisons chromatiques, il est conseillé de consulter le catalogue. Die Bilder dienen ausschließlich dazu, einige Lösungen und Abmessungen der Serie Rail darzustellen. Um ausführlich im Thema Abmessungen einzugehen, schlagen Sie bitte in der Preisliste nach. De afbeeldingen op de vorige pagina's dienen uitsluitend om een aantal mogelijke afmetingen van het assortiment Rail te illustreren. Voor meer details met betrekking tot afmetingen, afwerkingen en kleurcombinaties, zie de lijst. Las imágenes de las páginas anteriores sirven únicamente para representar algunas posibilidades dimensionales de la gama Rail. Para conocer las medidas exactas, los acabados y las combinaciones cromáticas, es aconsejable consultar la tarifa.*



- T_240 x 40 x 62 cm
94 1/2" x 15 3/4" x 24 1/2" in
- U_160 x 40 x 62 cm
63" x 15 3/4" x 24 1/2" in
- V_240 x 40 x 62 cm
94 1/2" x 15 3/4" x 24 1/2" in
- W_200 x 40 x 62 cm
78 3/4" x 15 3/4" x 24 1/2" in
- Z_240 x 40 x 62 cm
94 1/2" x 15 3/4" x 24 1/2" in



rail electrification system

_I cavi sono resi disponibili su piano attraverso fori con sistema passacavi.

_Cables are available on the top through cable grommet holes.

_Les câbles arrivent sur le plateau à travers des trous avec un système passe-câbles.

_Die Kabel stehen durch das Kabeldurchlasssystem auf der Tischplatte zur Verfügung.

_De kabels worden beschikbaar gemaakt op het blad door speciale kabeldoorvoeringen.

_Los cables resultan disponibles en el sobre gracias a unos orificios con sistema pasacables.

_Lo spazio permette il passaggio dei cavi ad anta chiusa. La pressione esercitata dalle spazzole tiene in posizione i cavi.

_The recess allows the passage of cables even with the door closed. The pressure exerted by the brushes maintains the cables in position.

_L'espace permet le passage des câbles quand la porte est fermée. La pression exercée par les brosses maintient les câbles à leur emplacement.

_Der ausreichende Raum ermöglicht die Kabeldurchführung bei geschlossener Tür. Der von den Bürsten ausgeübte Druck hält die Kabel in Position.

_Het is mogelijk om de kabels erdoor te steken met een gesloten deur. De druk die door de borstels wordt uitgevoerd houdt de kabels op hun plaats.

_El espacio permite el paso de los cables con la puerta cerrada. La presión ejercida por los cepillos mantiene los cables en su posición.

_I cavi sono alloggiati in un'ampia vaschetta e possono essere bloccati con fascette che si inseriscono in apposite fessure.

_The cables are collected in a wide tray and can be locked with clamps inserted in special slots.

_Les câbles sont logés dans un grand bac et peuvent être bloqués avec des colliers qui s'insèrent dans des fentes prévues à cet effet.

_Die Kabel sind in einem großen Behälter enthalten und können durch Klemmen, durch vorgesehene Schlitz, blockiert werden.

_De kabels worden ondergebracht in een ruime mand en kunnen geblokkeerd worden met behulp van klemmen die in de desbetreffende openingen worden gestoken.

_Los cables están alojados en una amplia bandeja y pueden bloquearse con bridas, que se introducen en unas ranuras.

_I cavi transitano in spazi ricavati all'interno del mobile.

_Cables pass through the recesses within the piece of furniture.

_Les câbles transitent dans des espaces situés à l'intérieur du meuble.

_Die Kabel werden innerhalb des Schrankes geführt.

_De kabels worden door ruimten aan de binnenkant van het meubel gestoken.

_Los cables se extienden a lo largo de los espacios obtenidos en el interior del mueble.

_I cavi, dalle prese, vengono raccolti sotto il mobile in un cestello dedicato.

_The cables are collected underneath the piece of furniture in a special tray.

_À partir des prises, les câbles sont rassemblés sous le meuble dans un panier prévu pour cela.

_Die Kabel werden von den Steckdosen unter dem Möbel in einem geeigneten Korb positioniert.

_De kabels worden vanaf de stopcontacten onder het meubel in een speciale mand verzameld.

_Los cables de las tomas de corriente se recogen debajo del mueble en una cesta.

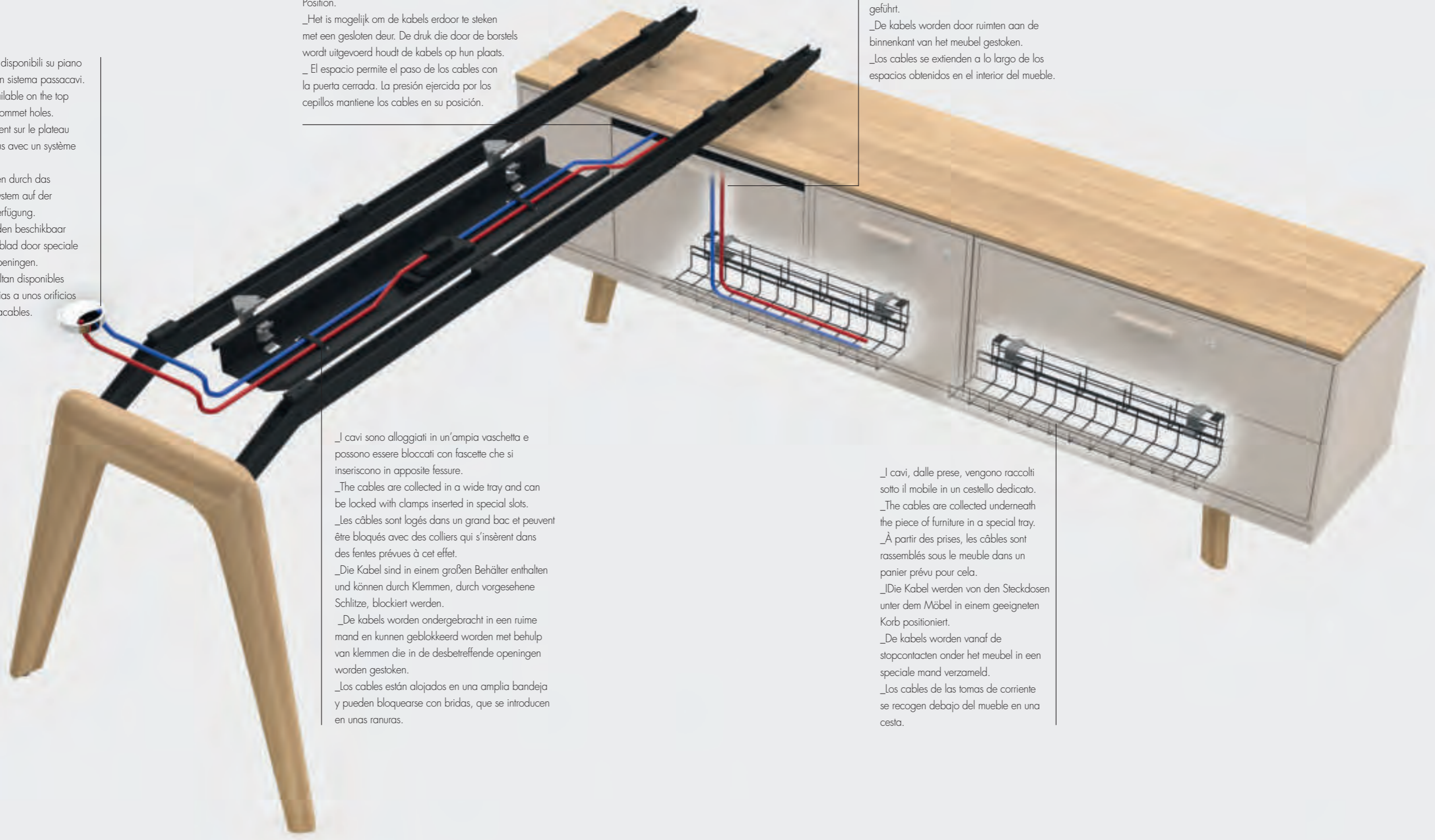

rail

finishes

legni

woods · bois · holz · hout · madera

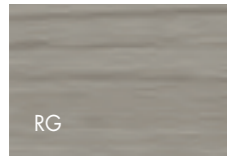

rovere grigio
grey oak
chêne gris
Eiche grau
grijs eiken
roble gris



rovere laccato nero
black lacquered oak
chêne laqué noir
schwarz lackierter Eiche
zwart gelakt eiken
roble lacado negro



rovere naturale
natural oak
chêne naturel
Natur Eiche
eikenhout natuur
roble natural

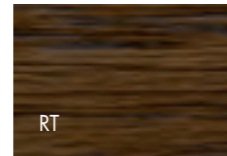

rovere tabacco
tobacco oak
chêne tabac
Eiche Tabak
eikenhout tabak
roble tabaco

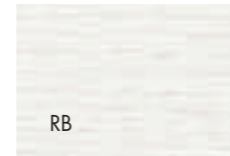

rovere laccato bianco
white lacquered oak
chêne laqué blanc
weiß lackierter Eiche
wit gelakt eiken
roble lacado blanco

laccati

lacquered · laqués · Lackiertes · gelakt · laqueado

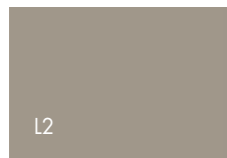

tortora
turtledove
tourterelle
taubengrau
tortelduif
törtola

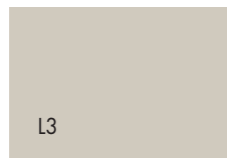

nebbia
mist
brouillard
nebelgrau
mist
niebla

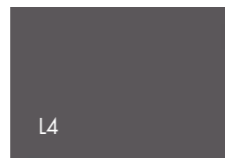

titanio
titanium
litane
Titan
titanium
titanio

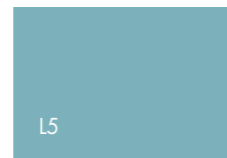

oceano
ocean
océan
Meerblau
ocean
océano

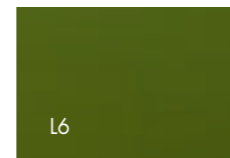

verde muschio
moss green
vert mousse
moosgrün
mosgroen
verde musgo

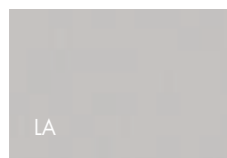

alluminio
aluminium
aluminium
Aluminium
aluminium
aluminio

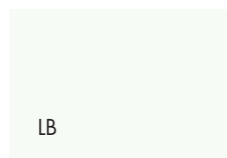

bianco
white
blanc
Weiß
wit
blanco



deep teal
deep teal
bleu canard
Deep Teal
deep teal
deep teal

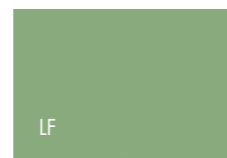

verde natura
gras green
vert nature
grasgrün
groene natuur
verde naturaleza



nero
black
noir
Schwarz
zwart
negro

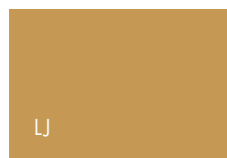

giallo gold
yellow gold
jaune or
goldgelb
geelgouden
loro amarillo



bordeaux
bordeaux
bordeaux
bordeaux
bordeaux
burdeos

melaminici

melamine · mélamine · Melamin · melamine · melamina

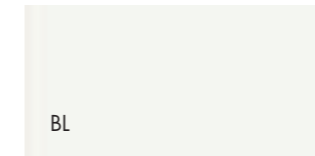

bianco
white
blanc
weiß
wit
blanco

parti metalliche

metal parts · pièces métalliques · metallteile · metalen onderdelen · piezas de metal



chromo lucido
glossy chrome
chromé brillant
Chrom poliert
glanzend verchroomd
chromo pulido

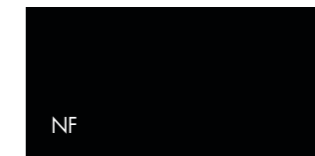

nero
black
noir
Schwarz
zwart
negro

vetro temperato

tempered glass · verre trempé · gehärtetes Glas · gehard glas · vidrio templado

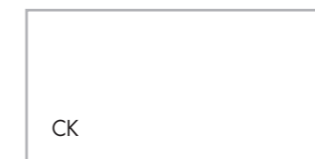

trasparente
transparent
transparent
Transparentes
transparente
transparente

vetroceramica

glass ceramic · vitroceramique · glaskeramik · vitrokeramisch · vitroceramica

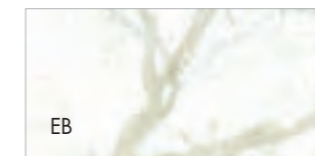

Bianco Calacatta lucido
Glossy white Calacatta
Blanc brillant Calacatta
Weiß glänzend Calacatta
Glanzend wit Calacatta
Calacatta blanco brillo



Grigio Stone opaco
Stone grey matt
Gris mat Stone
Grau matt Stone
Grijs Stone mat
Gris mate Stone



Nero Marquinia opaco
Marquinia black matt
Noir mat Marquinia
Schwarz matt Marquinia
Zwart Marquinia mat
Marquinia negro mate

pelle ecologica

eco leather · cuir écologique · ecopell-leder · Kunstleder · piel ecológica



nero
black
noir
Schwarz
zwart
negro

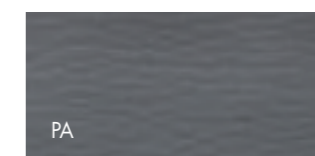

titanio
titanium coloured
titane
Titan
titanium
titanio

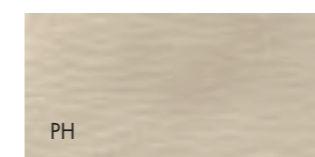

Nebbia
dark white colour
brouillard
Nebel
Grijswit
gris claro

rail

technical info

scrivania in legno · wooden desk · bureau en bois
Schreibtisch aus Holz · bureau in hout · escritorio de madera



200 x 100 x 75 cm
78 3/4" x 39 1/4" x 29 1/2" in
220 x 100 x 75 cm
86 3/4" x 39 1/4" x 29 1/2" in
240 x 100 x 75 cm
94 1/2" x 39 1/4" x 29 1/2" in

scrivania in vetro · glass desk · bureau en verre
Schreibtisch aus Glas · bureau in glas · escritorio de cristal



200 x 100 x 75 cm
78 3/4" x 39 1/4" x 29 1/2" in
220 x 100 x 75 cm
86 3/4" x 39 1/4" x 29 1/2" in
240 x 100 x 75 cm
94 1/2" x 39 1/4" x 29 1/2" in

L x P x H

scrivania in legno · wooden desk · bureau en bois
Schreibtisch aus Holz · bureau in hout · escritorio de madera

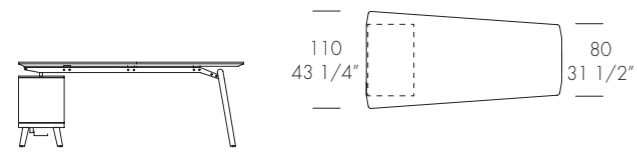

220 x 110 x 75 cm
86 3/4" x 43 1/4" x 29 1/2" in

scrivania in vetro · glass desk · bureau en verre
Schreibtisch aus Glas · bureau in glas · escritorio de cristal

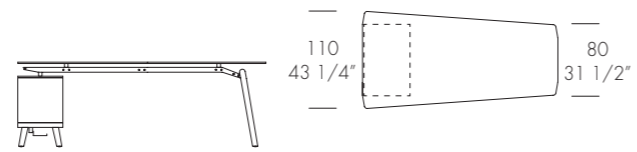

220 x 110 x 75 cm
86 3/4" x 43 1/4" x 29 1/2" in

L x P x H

pannello modesty · modesty panel · voile de fond · Modesty Paneel · knieschot · panel de protección

L x P x H

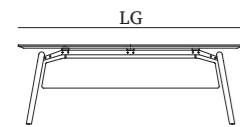

LG 200 152 x 1,9 x 28
LG 220 172 x 1,9 x 28
LG 240 192 x 1,9 x 28

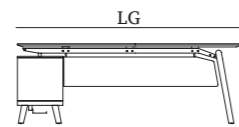

LG 78 3/4" 59 3/4" x 3/4" x 11" in
LG 86 3/4" 67 3/4" x 3/4" x 11" in
LG 34 1/2" 75 1/2" x 3/4" x 11" in

LG 200 135 x 1,9 x 28
LG 220 155 x 1,9 x 28
LG 240 175 x 1,9 x 28

LG 78 3/4" 53" x 3/4" x 11" in
LG 86 3/4" 61" x 3/4" x 11" in
LG 34 1/2" 68 3/4" x 3/4" x 11" in

posizione passacavi · cable guide position · position passe-câbles · Kabeldurchlass Position · positie kabeldoorvoer · posición pasacables

Ø 80 - Ø 3"

scrivania in legno · wooden desk · bureau en bois
Schreibtisch aus Holz · bureau in hout · escritorio de madera

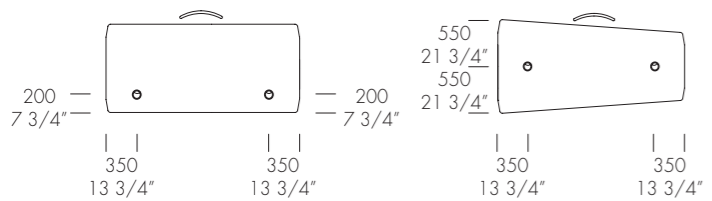

scrivania in vetro · glass desk · bureau en verre
Schreibtisch aus Glas · bureau in glas · escritorio de cristal

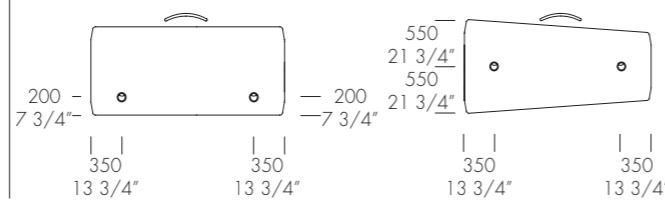

* con passacavi · with cable guide · avec passe-câbles · mit Kabeldurchlass · met kabeldoorvoer · con pasacables

tavolo riunione in legno · wooden conference table · table de réunion en bois
Konferenztisch aus Holz · vergadertafel in hout · mesa de reuniones de madera

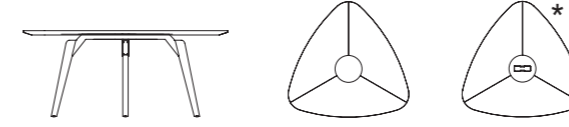

179,5 x 172 x 75 cm
70 3/4" x 67 3/4" x 29 1/2" in

tavolo riunione in vetro · glass conference table · table de réunion en verre
Konferenztisch aus Glas · vergadertafel in glazen · mesa de reuniones de cristal

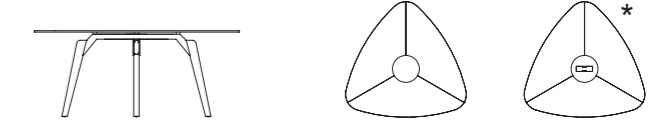

179,5 x 172 x 75 cm
70 3/4" x 67 3/4" x 29 1/2" in



120 x 120 x 75 cm
47 1/4" x 47 1/4" x 29 1/2" in
160 x 160 x 75 cm
63" x 63" x 29 1/2" in



120 x 120 x 75 cm
47 1/4" x 47 1/4" x 29 1/2" in
160 x 160 x 75 cm
63" x 63" x 29 1/2" in



240 x 120 x 75 cm
94 1/2" x 47 1/4" x 29 1/2" in
280 x 120 x 75 cm
110 1/4" x 47 1/4" x 29 1/2" in

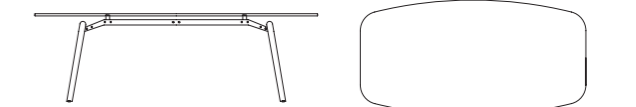

240 x 120 x 75 cm
94 1/2" x 47 1/4" x 29 1/2" in

tavolo riunione in legno · wooden conference table · table de réunion en bois · Konferenztisch aus Holz · vergadertafel in hout · mesa de reuniones de madera



360 x 120 x 75 cm
141 3/4" x 47 1/4" x 29 1/2" in

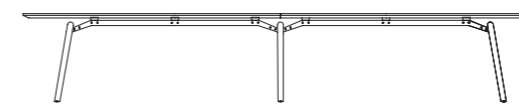

440 x 120 x 75 cm
173 1/4" x 47 1/4" x 29 1/2" in

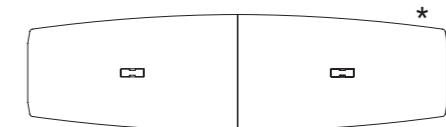
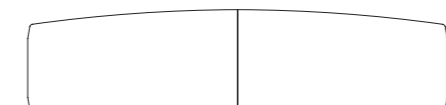

rail

technical info

mobili di servizio · service cabinets · dessertes · Werkbox/Module · meubels · muebles de servicio

L x P x H

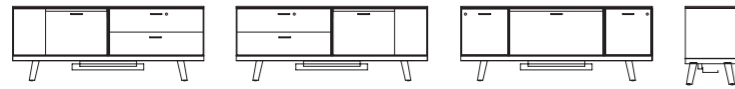

160 x 40 x 62 cm
63" x 15 3/4" x 24 1/2" in

160 x 40 x 62 cm
63" x 15 3/4" x 24 1/2" in

160 x 40 x 62 cm
63" x 15 3/4" x 24 1/2" in

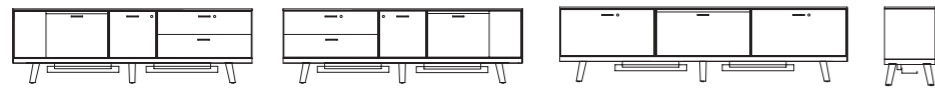

200 x 40 x 62 cm
78 3/4" x 15 3/4" x 24 1/2" in

200 x 40 x 62 cm
78 3/4" x 15 3/4" x 24 1/2" in

240 x 40 x 62 cm
94 1/2" x 15 3/4" x 24 1/2" in

credenze · cabinets · armoires basses · Schränke · kasten · aparadores

L x P x H

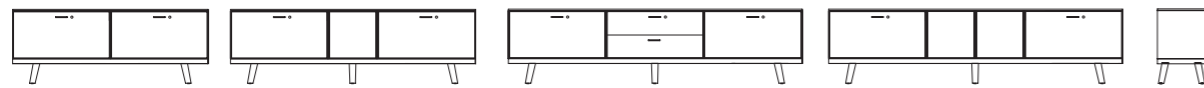

160 x 40 x 62 cm
63" x 15 3/4" x 24 1/2" in

200 x 40 x 62 cm
78 3/4" x 15 3/4" x 24 1/2" in

240 x 40 x 62 cm
94 1/2" x 15 3/4" x 24 1/2" in

240 x 40 x 62 cm
94 1/2" x 15 3/4" x 24 1/2" in

mobili di servizio · service cabinets · dessertes · Werkbox/Module · meubels · muebles de servicio

L x P x H

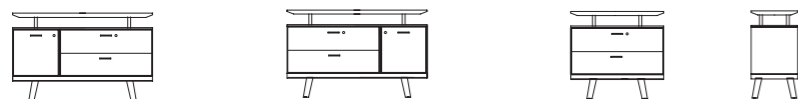

legno · wood
bois · Holz
hout · madera

120 x 40 x 75 cm
47 1/4" x 15 3/4" x 29 1/2" in

legno · wood
bois · Holz
hout · madera

120 x 40 x 75 cm
47 1/4" x 15 3/4" x 29 1/2" in

legno · wood
bois · Holz
hout · madera

80 x 40 x 75 cm
31 1/2" x 15 3/4" x 29 1/2" in

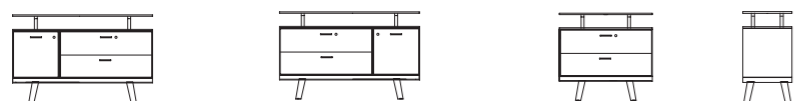

vetro · glass
verre · Glas
glas · cristal

120 x 40 x 75 cm
47 1/4" x 15 3/4" x 29 1/2" in

vetro · glass
verre · Glas
glas · cristal

120 x 40 x 75 cm
47 1/4" x 15 3/4" x 29 1/2" in

vetro · glass
verre · Glas
glas · cristal

80 x 40 x 75 cm
31 1/2" x 15 3/4" x 29 1/2" in

credenze · cabinets · armoires basses · Schränke · kasten · aparadores

L x P x H

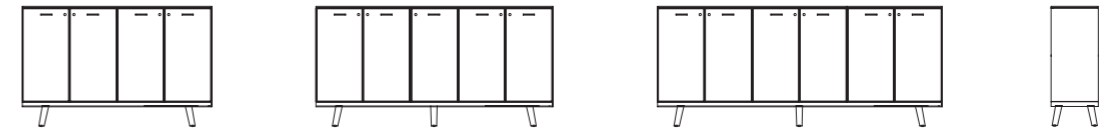

160 x 40 x 102 cm
63" x 15 3/4" x 40" in

200 x 40 x 102 cm
78 3/4" x 15 3/4" x 40" in

240 x 40 x 102 cm
94 1/2" x 15 3/4" x 40" in

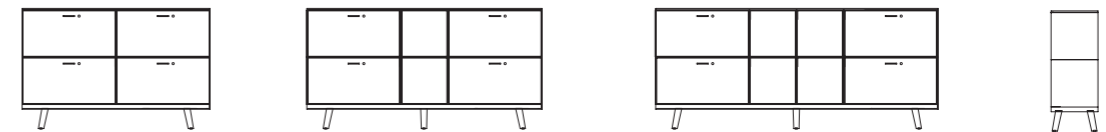

160 x 40 x 102 cm
63" x 15 3/4" x 40" in

200 x 40 x 102 cm
78 3/4" x 15 3/4" x 40" in

240 x 40 x 102 cm
94 1/2" x 15 3/4" x 40" in

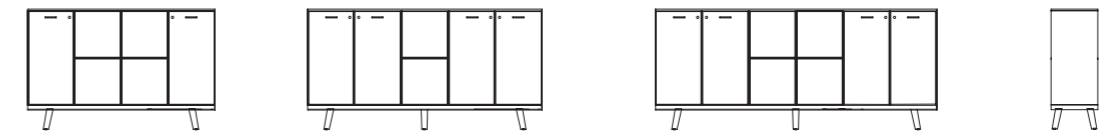

160 x 40 x 102 cm
63" x 15 3/4" x 40" in

200 x 40 x 102 cm
78 3/4" x 15 3/4" x 40" in

240 x 40 x 102 cm
94 1/2" x 15 3/4" x 40" in

GAMBE - legs - piètements - beine - poten - patas



STRUTTURA A T

T-shaped structure - structure en T - T-gestell - T-vorm onderstel - estructura en T



STRUTTURA AD L

L-shaped structure - structure en L - L-gestell - L-vorm onderstel - estructura en L

FISSA H 74 - 29" - fixed - fixe - feststehend - vast - fija



L 60 - 80
23 3/4" - 31 1/2"

L 80
31 1/2"

MOBILE - mobile - mobile - beweglich - verplaatsbaar - móvil

PULSANTE

H 65/85 - 25 1/2" / 33 1/2"
push button - bouton-poussoir -
schalter - drukknop - pulsador



L 60 - 80
23 3/4" - 31 1/2"

L 80
31 1/2"

MANOVELLA

H 65/85 - 25 1/2" / 33 1/2"
crank - manivelle - kurbel -
slinger - manivela



L 80
31 1/2"

ELETTRICA

H 65/130 - 25 1/2" / 51"
electrical - électrique - elektrisch -
elektrisch - eléctrico

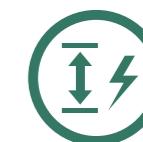

L 80
31 1/2"

RIBALTABILE H 74 - 29" - folding leg - rabattable - klappbar - opklapbaar - abatible

SU RUOTE

with castors - sur roulettes - auf
rollen - op wielen - sobre ruedas

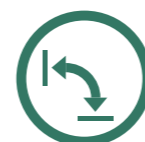

L 80
31 1/2"

winglet™

un sistema pensato e realizzato
in conformità e nel rispetto
della normativa Europea
EN 527-1:2011

a system designed and built in
compliance with
European Standard
EN 527-1:2011

un système conçu et réalisé
en conformité et dans le respect
de la norme Européenne
EN 527-1:2011

ein in Übereinstimmung mit der
europäischen Normvorschrift EN
527-1: 2011 und unter Einhaltung
der entsprechenden Bestimmungen
konzipiertes und hergestelltes System

een systeem dat ontworpen en
gerealiseerd is
in overeenstemming
met de Europese regelgeving
EN 527-1:2011

un sistema pensado y realizado
en cumplimiento y conformidad
de la normativa europea
EN 527-1:2011

La normativa individua 4 tipologie di scrivanie

The standard includes 4 different types of desktops - La norme
identifie 4 typologies de bureaux - Die Normvorschrift sieht 4
Arten von Schreibtischen vor - De regelgeving vermeldt 4 soorten
schrijftafels - La normativa identifica 4 tipos de escritorios

1. TIPO A - TYPE A - TYPE A - TYP A - TYPE A - TIPO A

Scrivanie ad altezza regolabile in continuo anche da parte dell'utente

Continuously height-adjustable desktops - Bureaux à hauteur réglable en continu en
cours d'utilisation - Schreibtische, die auch vom Benutzer stufenlos höhenverstellbar sind
- Schrijftafels waarvan de hoogte voortdurend door de gebruiker versteld kan worden -
Escritorios de altura regulable de modo continuo, incluso por parte del usuario

2. TIPO B - TYPE B - TYPE B - TYP B - TYPE B - TIPO B

Scrivanie ad altezza selezionabile al momento dell'installazione

Desktops whose height can be adjusted at the time of installation - Bureaux à hauteur
sélectionnable lors du montage - Schreibtische, deren Höhe beim Aufbau wählbar ist -
Schrijftafels waarvan de hoogte ingesteld kan worden tijdens de installatie - Escritorios de
altura seleccionable en el momento de la instalación

3. TIPO C - TYPE C - TYPE C - TYP C - TYPE C - TIPO C

Scrivanie ad altezza fissa

Fixed height desktops - Bureaux à hauteur fixe - Schreibtische mit feststehender Höhe -
Schrijftafels met vaste hoogte - Escritorios de altura fija

4. TIPO D - TYPE D - TYPE D - TYP D - TYPE D - TIPO D

Scrivanie ad altezza regolabile o selezionabile, ma con intervallo di regolazione ridotto

Height-adjustable desktops with reduced setting range - Bureaux à hauteur réglable ou
sélectionnable mais avec une plage de réglage limitée - Schreibtische mit verstellbarer
bzw. wählbarer Höhe, aber mit eingeschränktem Einstellintervall - Schrijftafels met
verstelbare of instelbare hoogte, maar met een beperkte verstelbaarheid - Escritorios de
altura regulable o seleccionable, pero con intervalo de regulación reducido

FISSA H 74 - 29" - fixed - fixe - feststehend - vast - fija

TIPO C
TYPE C - TYPE C
TYP C - TYPE C
TIPO C

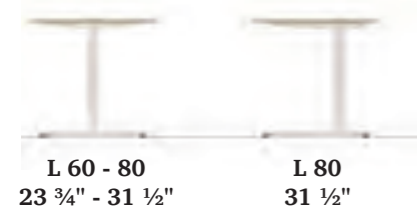

MANOVELLA H 65/85 - 25 1/2"/33 1/2" - crank - manivelle - kurbel - slinger - manivela

TIPO D
TYPE D - TYPE D
TYP D - TYPE D
TIPO D

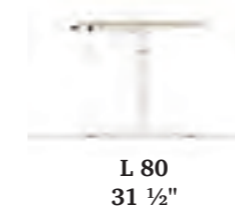

PULSANTE H 65/85 - 25 1/2"/33 1/2" - push button - bouton-poussoir - schalter - drukknoop - pulsador

TIPO B
TYPE B - TYPE B
TYP B - TYPE B
TIPO B

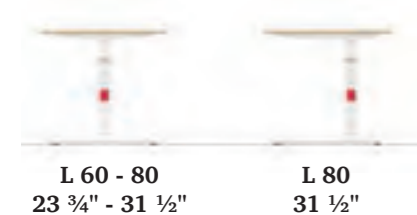

Uno scatto ogni 2 cm - One step every 2 cm - Un cran tous les 2 cm - Eine Kerbe alle 2 cm - Eén klik om de 2 cm - Una posición cada 2 cm

h max: 85 - 33 1/2"

↑ 67 - 26 1/4", ↑ 69 - 27", ↑ 71 - 28", ↑ 73 - 28 3/4",
↑ 75 - 29 1/2", ↑ 77 - 30 1/4", ↑ 79 - 31", ↑ 81 - 31 3/4",
↑ 83 - 32 3/4"

h min: 65 - 25 1/2"

ELETTRICA H 65/130 - 25 1/2"/51" - electrical - électrique - elektrisch - elektrisch - eléctrico

TIPO A
TYPE A - TYPE A
TYP A - TYPE A
TIPO A

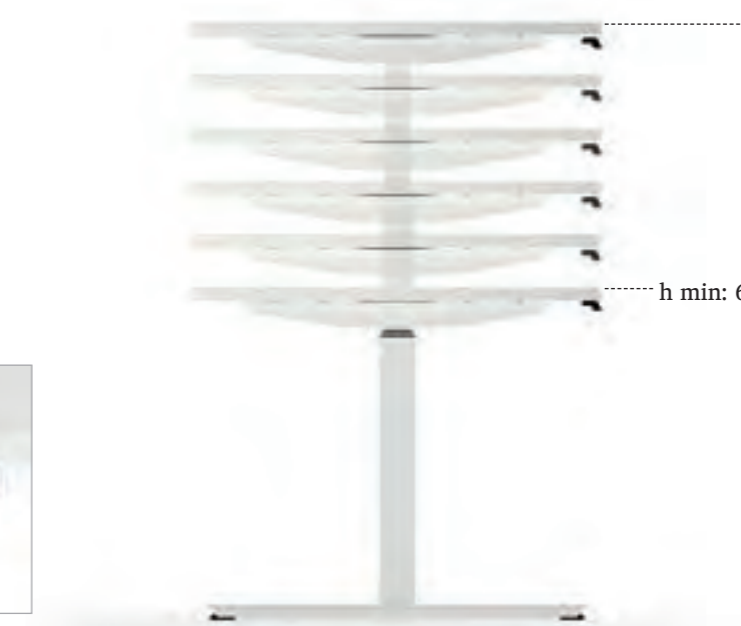

ESTENSIONE - extention - extension - erweiterung - uitbreiding - extensión

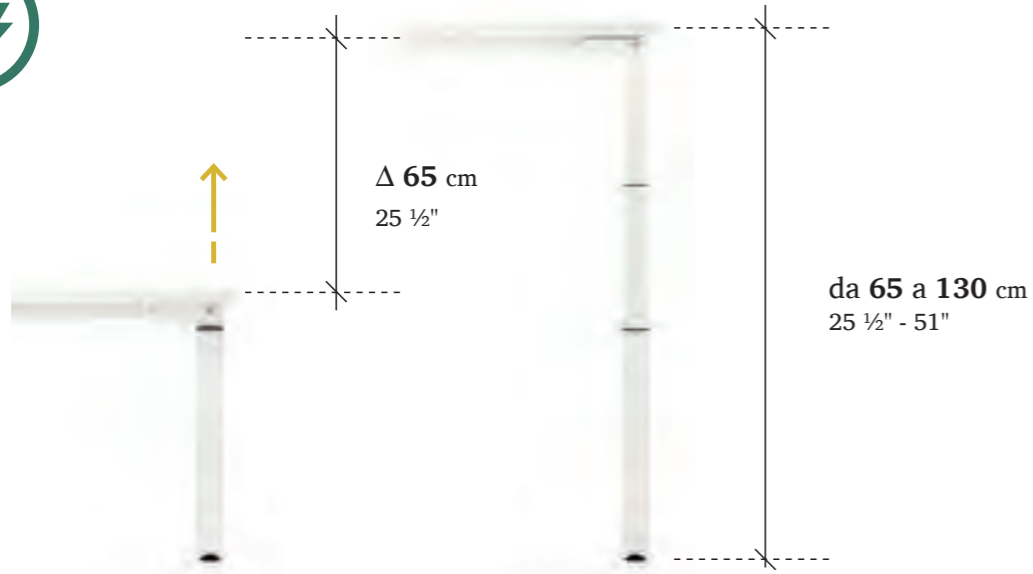
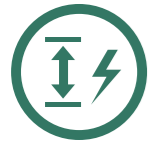

LAVORO DA SEDUTO O IN PIEDI

work standing or sitting down - travail assis ou debout - arbeit im sitzen oder im stehen - zittend of rechtstaand werken - trabajo sentado o de pie

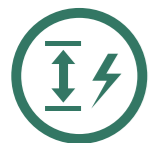

TRAVI TELESCOPICHE - telescopic beams - poutres télescopiques - teleskoptraversen - telescopische buisjes - vigas telescópicas

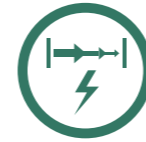

**Semplice, facile, riconfigurabile:
tre misure, una sola struttura
telescopica**

Simple, easy, adjustable:
three measures, one telescopic structure

Simple, facile, reconfigurable :
trois dimensions, une seule structure
télescopique

Simpel, einfach, rekonfigurierbar: drei
Abmessungen, ein einziges ausziehbares Gestell

Eenvoudig, gemakkelijk, herconfigureerbaar:
Drie afmetingen, één telescopisch onderstel

Simple, fácil, reconfigurable:
tres medidas, una sola estructura
telescópica



DA SCRIVANIA A BENCH

from desktop to bench - de bureau à bench - von schreibtisch zu bench -
van schrijftafel tot bench-compositie - de escritorio a bench



versione standard
Standard version - Version standard -
Standard-Version - Standaardversie -
Versión estándar



Travi fisse di collegamento 1 e 2
Fixed connection beams 1 & 2 - Poutres fixes de liaison 1
et 2 - Feststehende Verkettungstraversen 1 und 2 - Vaste
verbindingsbuizen 1 en 2 - Vigas fijas de conexión 1 y 2



2° Scrivania
Second desktop - 2e Bureau -
2. Schreibtisch - 2e Schrijftafel -
2.º Escritorio



Vasca passacavi telescopica
Telescopic cable holder tray - Bac passe-câbles
télescopique - Ausziehbare Kabelrinne - Telescopische
kabelgoot - Bandeja pasacables telescópica

TIPO A - TYPE A - TYPE A - TYP A - TYPE A - TIPO A



Esempi di configurazione con e senza muretto
Layout examples with and without wall - Exemples de configuration
avec et sans piètement plein - Konfigurationsbeispiele mit und ohne
Wange - Configuratievoorbeelden met en zonder wand - Ejemplos de
configuración con y sin tabique



TAVOLO SU RUOTE CON PIANO RIBALTABILE - wheeled table with folding leg - table sur roulettes avec plateau rabattable - tisch auf rollen mit klappbarer platte - tafel op wielen met opklapbaar paneel - mesa sobre ruedas con sobre abatible

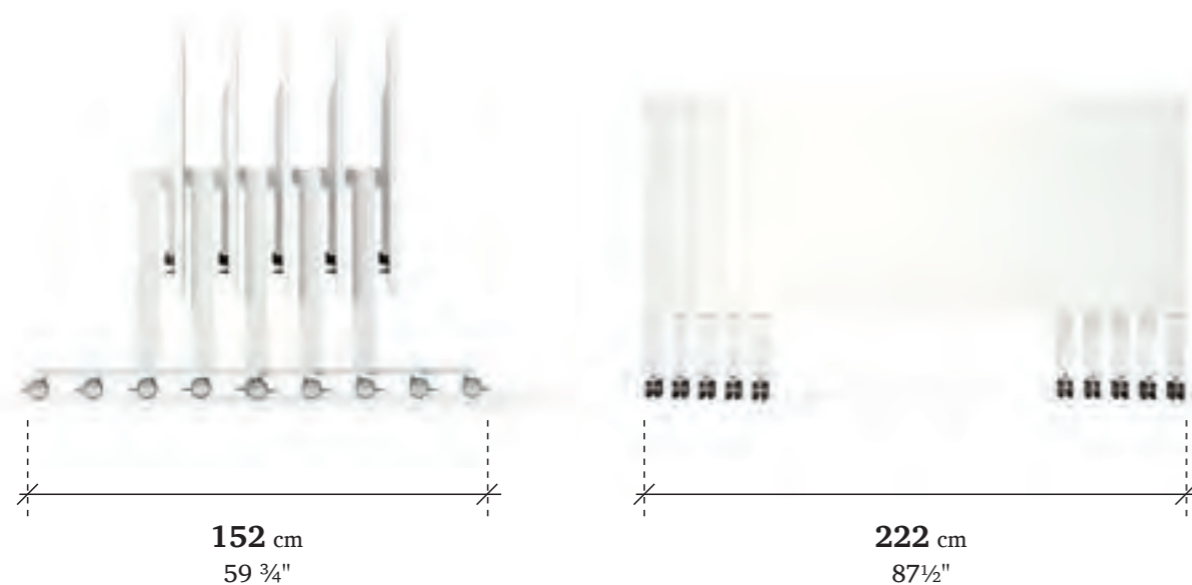
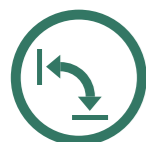

Un sistema semplice e veloce per ridurre al minimo gli ingombri

A simple and fast system to reduce the footprint to a minimum

Un système simple et rapide pour réduire au minimum l'encombrement

Ein einfaches und schnelles System, um den Platzbedarf zu minimieren

Een eenvoudig en snel systeem, om de ingenomen plaats tot een minimum te beperken

Un sistema simple y rápido para reducir al mínimo los volúmenes





bench system

TIPO A
TYPE A - TYPE A
TYP A - TYPE A
TIPO A

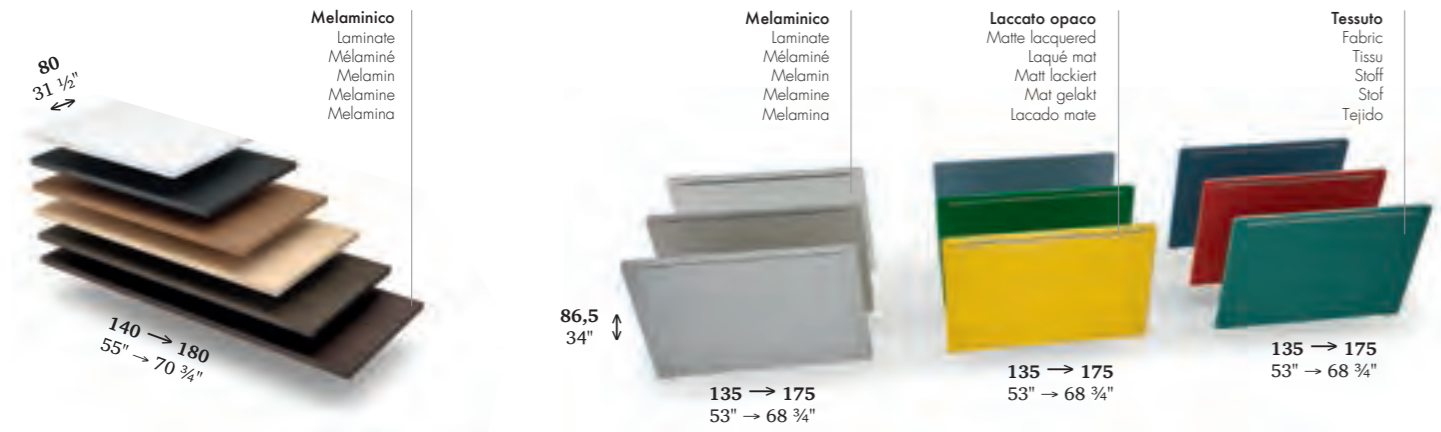

Gamba centrata
Middle leg
Piétement centré
Bain in der Mitte
Gecentreerde poot
Pata centrada

Gamba pannello
Panel leg
Piétement panneau
Plattenbein
Poot paneel
Pata tablero

Pannelli di tamponamento
Side panels
Panneaux de remplissage
Seitenpaneele
Bufferpanelen
Tableros de compensación

Muretto
Side panels
Panneaux de remplissage
Seitenpaneele
Bufferpanelen
Tableros de compensación



bench system

TIPO D
TYPE D - TYPE D
TYP D - TYPE D
TIPO D

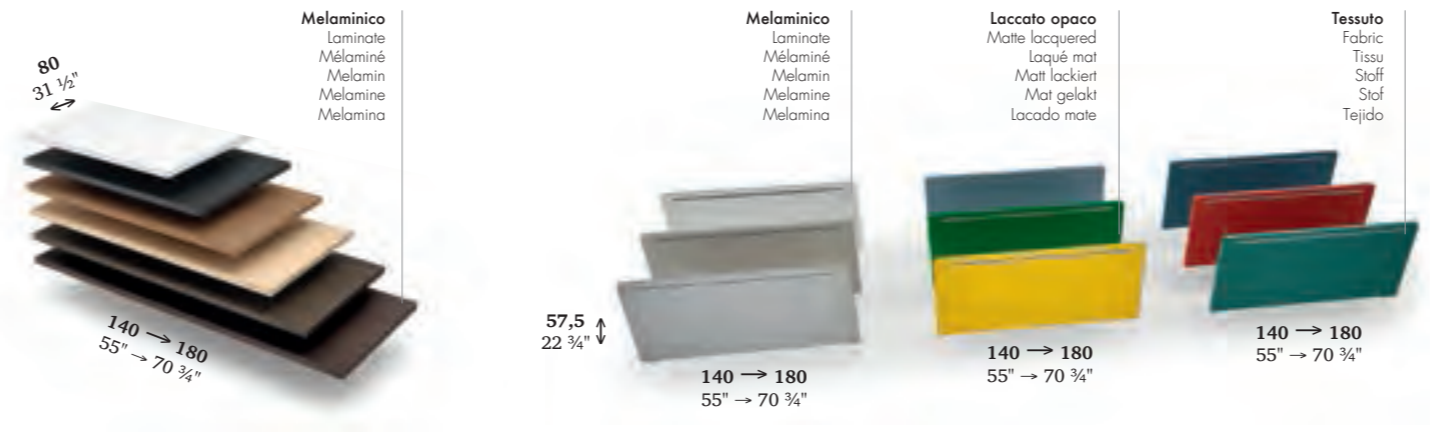

Gamba centrata
Middle leg
Piétement centré
Bain in der Mitte
Gecentreerde poot
Pata centrada

Gamba pannello
Panel leg
Piétement panneau
Plattenbein
Poot paneel
Pata tablero

Pannelli di tamponamento
Side panels
Panneaux de remplissage
Seitenpaneele
Bufferpanelen
Tableros de compensación



desk system

TIPO B
TYPE B - TYPE B
TYP B - TYPE B
TIPO B

TIPO C
TYPE C - TYPE C
TYP C - TYPE C
TIPO C

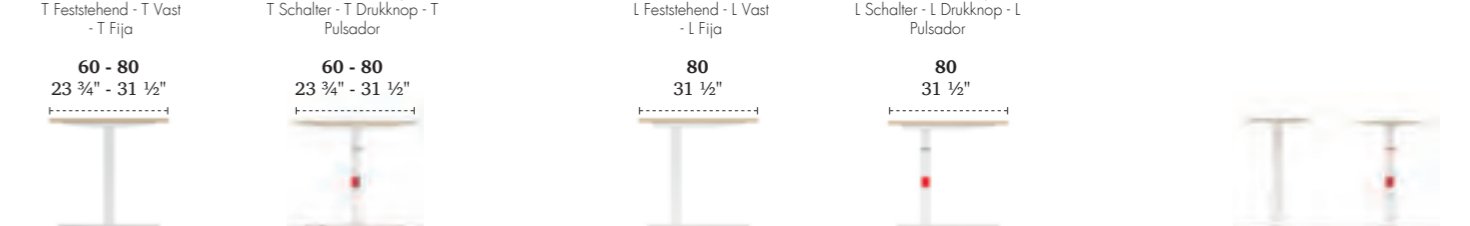
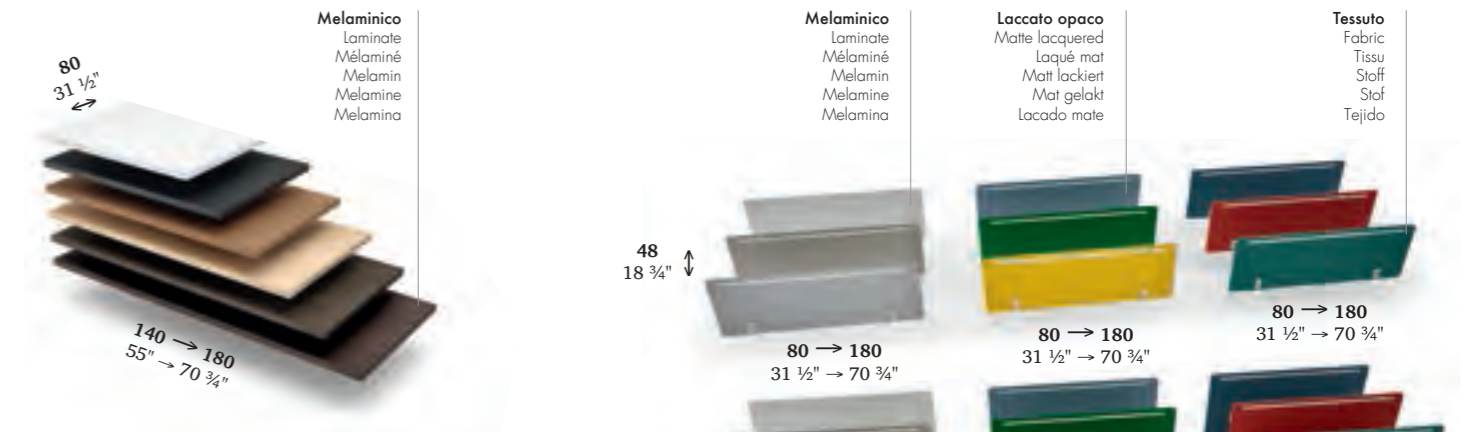

T Fissa
Fixed T-shaped structure - T Fixe
T Feststehend - T Vast
- T Fija

60 - 80
23 3/4" - 31 1/2"

T Pulsante
T-shaped structure with push button - T avec bouton-poussoir
T Schalter - T Drukknop - T Pulsador

60 - 80
23 3/4" - 31 1/2"

L Fissa
Fixed L-shaped structure - L Fixe
L Feststehend - L Vast
- L Fija

80
31 1/2"

L Pulsante
L-shaped structure with push button - L avec bouton-poussoir
L Schalter - L Drukknop - L Pulsador

80
31 1/2"

Fissa centrale
Fixed middle structure
Fixé central
Feststehend in der Mitte
Vast gecentreerd
Fija central

Reg. in H. a pulsante centrale
Heightadjustable structure with central push button
Rég. en H. avec bouton-poussoir central
Höhenverstellbar mit Schalter in der Mitte
Hoogte instelbaar met gecentreerde drukknop
Rég. en H. con pulsador central

Fissa decentrata
Fixed decentralized structure
Fixé décentré
Feststehend außermittig
Vast aan de zijkant
Fija descentrada

Reg. in H. a pulsante decentrata
Heightadjustable structure with decentralized push button
Rég. en H. avec bouton-poussoir décentré
Höhenverstellbar mit außermittigem Schalter
Hoogte instelbaar met drukknop aan de zijkant
Rég. en H. con pulsador descentrada

Puntale
Ferrule
Piétement
Stützbein
Punt
Pata de apoyo

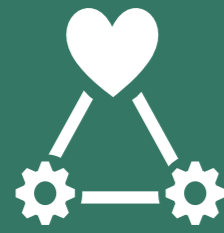

Una struttura collaudata un "cuore" forte e tecnologico, soluzioni sicure, affidabili e silenziose con 2 motori

A tested structure, a strong and tech-savvy core, safe, reliable and noiseless solutions with 2 motors - Une structure éprouvée, un « cœur » puissant et technologique, des solutions sûres, fiables et silencieuses avec 2 moteurs - Ein bewährtes Gestell mit einem starken und technologischen "Herzen", sichere, zuverlässige und geräuscharme Lösungen mit 2 Motoren - Een getest onderstel, een sterk en technologisch "hart", veilige oplossingen, betrouwbaar en geruisloos met 2 motoren - Una estructura probada: un « corazón » fuerte y tecnológico, soluciones seguras, fiables y silenciosas con 2 motores



Altezza minima/massima:

62,5/127,5 cm da terra a sotto piano.
Minimum/maximum height: 62,5/127,5 cm from the ground to the top. - Hauteur minimale/maximale : 62,5/127,5 cm du sol jusqu'au-dessus du plateau. - Minimale/maximale Höhe: 62,5/127,5 cm vom Boden bis zur Oberkante der Tischplatte. - Min./max. hoogte: 62,5/127,5 cm van de vloer tot bovenkant blad. - Altura mínima/máxima: 62,5/127,5 cm desde el suelo hasta encima del sobre.



Passo a regolazione continua.

Continuous adjustment pitch. - Pas à réglage continu. - Stufenlos einstellbare Höhe. - Met continu instelling. - Paso de regulación continua.



Regolazione con pulsante up&down in dotazione.

Up&down button adjustment supplied. - Réglage avec bouton up&down fourni. - Einstellung mit standardmäßigem Up&Down-Schalter. - Instelling met bijgeleverde up&down-drukknop. - Regulación con pulsador up&down suministrado.



Regolazione disponibile, su richiesta, con pulsante up&down, display LCD con indicata la misura e memoria su 4 posizioni.

Up&down button adjustment supplied. - Réglage avec bouton up&down fourni. - Einstellung mit standardmäßigem Up&Down-Schalter. - Instelling met bijgeleverde up&down-drukknop. - Regulación con pulsador up&down suministrado.



Cicli di utilizzo: 10.000 cicli certificati.

Electric motor has been tested and certified for 10,000 cycles of use - Cycles d'utilisation : 10 000 cycles certifiés - Verwendungszyklen: 10.000 zertifizierte Zyklen - Test: 10.000 gecertificeerde bewegingen - Ciclos de uso: 10 000 ciclos certificados.



Peso massimo elevabile: 120 Kg (uniformemente distribuiti).

Maximum weight load: 120 kg (uniformly distributed) - Poids maximum relevable : 120 kg (distribués uniformément) - Höchste Traglast: 120 kg (gleichmäßig verteilt) - Maximaal gewicht tijdens verstellen: 120 kg (gelijkmatig verdeeld) - Peso máximo elevable: 120 kg (uniformemente distribuidos)



Presenza di fermi di sicurezza: sia in salita che in discesa.

Lifting and lowering safety retainers - Présence de butées de sécurité : vers le haut et vers le bas - Sicherheitsarretierung: Aufwärts und abwärts - Veiligheidsslot tijdens omhoog- en omlaag bediening - Presencia de topes de seguridad: tanto en subida como en bajada



Certificazioni di conformità TUV sull'impianto elettrico.

Lifting and lowering safety retainers - Présence de butées de sécurité : vers le haut et vers le bas - Sicherheitsarretierung: Aufwärts und abwärts - Veiligheidsslot tijdens omhoog- en omlaag bediening - Presencia de topes de seguridad: tanto en subida como en bajada



Meccanismo premontato all'origine e motori integrati nella gamba, plug&play.

Plug&play; pre-fitted mechanism and leg motors. - Mécanisme préinstallé à l'origine et moteurs incorporés dans le piètement, plug&play. - Vorinstallierter Mechanismus und im Tischbein integrierte Motoren, Plug&Play. - Voorgemonteerd mechanische en ingebouwde motoren in de poot, plug&play. - Mecanismo premontado de fábrica y motores integrados en la pata, plug&play.



Rumorosità di funzionamento: 39 dB.

Noise output: 39dB - Bruit de fonctionnement : 39 dB - Betriebsgeräusch: 39 dB - Geluid: 39 dB - Nivel de ruido durante el funcionamiento: 39 dB

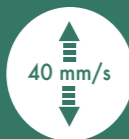

Velocità di salita/discesa: 40 mm/s.

Lifting/lowering speed = 40mm/second - Vitesse de montée/descente : 40 mm/s - Geschwindigkeit auf/ab: 40 mm/s - Omhoog- en omlaag snelheid: 40 mm/s. - Velocidad de subida/bajada: 40 mm/s



Consumo energetico: 0.00277kWh/giorno, 0,87Kwh/anno considerando 3 regolazioni giornaliere.

Energy consumption: 0,00277kw/day, 0,87/year based on 3 daily adjustments. - Consommation d'énergie : 0,00277 kWh/jour, 0,87 kWh/an, considérant 3 réglages quotidiens - Energieverbrauch: 0,00277 kWh/Tag, 0,87 kWh/Jahr bei 3 täglichen Verstellungen - Energieverbruik: 0,00277 kWh/dag, 0,87 kWh/jaar, bij 3 maal daags gebruik - Consumo energético: 0,00277 kWh/día, 0,87 kWh/año considerando 3 regulaciones diarias

winglet executive

winglet[™] executive

Gambe: verniciate epox bianco / **Piani + mobile**
Eko + credenza: melaminico rovere naturale /
Ante credenza: vetro temperato satinato

Legs: white epoxy paint finish / Tops + Eko cabinet +
sideboard: natural oak laminate / Sideboard doors:
satin-finished tempered glass

Prètements: laqués epoxy blanc / Plateaux + meuble
Eko + armoire basse: mélaminé chêne naturel / Portes
armoire basse: verre trempé satiné

Beine: Pulverbeschichtung Weiß / Tischplatten +
Möbel Eko + Sideboard: Melamin Eiche Natur / Türen
Sideboard: mattiertes temperiertes Glas

Poten: wit geverfd epoxy / Bladen + meubel Eko +
kast: melamine eikenhout natuur / Kastdeuren: gesa-
fineerd gehard glas

Patas: barnizadas epoxi blanco / Sobres + mueble Eko
+ aparador: melamina roble natural / Puertas aparador
cristal templado satinado



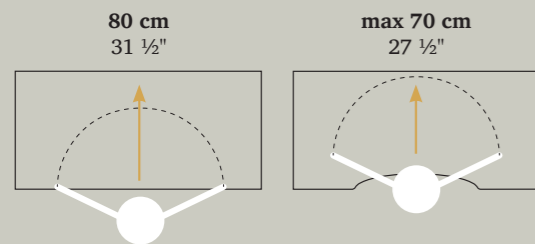

Scrivania

Desktop - Bureau -
Schreibtisch - Schrijftafel
- Escritorio

Scrivania ERGO

Ergo desktop - Bureau Ergo -
Schreibtisch ERGO - Schrijftafel
ERGO - Escritorio Ergo

**Gambe: verniciate epox bianco / Piani + mobile Eko:
melaminico rovere naturale / Ante
credenza: vetro temperato satinato**

Legs: white epoxy paint finish / Tops + Eko cabinet +
sideboard: natural oak laminate / Sideboard doors:
satin-finished tempered glass

Piètements: laqués epoxy blanc / Plateaux + meuble Eko
+ armoire basse: mélaminé chêne naturel / Portes armoire
basse: verre trempé satiné

Beine: Pulverbeschichtung Weiß / Tischplatten + Möbel
Eko + Sideboard: Melamin Eiche Natur / Türen Side-
board: mattiertes temperiertes Glas

Poten: wit gevefd epoxy / Bladen + meubel Eko + kast:
melamine eikenhout natuur / Kastdeuren: gesatineerd
gehard glas

Patas: barnizadas epoxi blanco / Sobres + mueble Eko
+ aparador: melamina roble natural / Puertas aparador
cristal templado satinado

**Gambe: verniciate epox bianco / Piani + mobile Eko:
melaminico rovere naturale**

Legs: white epoxy paint finish / Tops + Eko cabinet:
natural oak laminate

Piètements: laqués epoxy blanc / Plateaux + meuble Eko :
mélaminé chêne naturel

Beine: Pulverbeschichtung Weiß / Tischplatten + Möbel
Eko: Melamin Eiche Natur

Poten: wit gevefd epoxy / Bladen + meubel Eko: melami-
ne eikenhout natuur

Patas: barnizadas epoxi blanco / Sobres: melamina roble
natural



**Gambe: verniciate epox bianco / Piani + mobile
Eko + credenza: melaminico rovere naturale / Ante
credenza: vetro temperato satinato**

Legs: white epoxy paint finish / Tops + Eko cabinet +
sideboard: natural oak laminate / Sideboard doors:
satin-finished tempered glass

Piètements: laqués epoxy blanc / Plateaux + meuble Eko
+ armoire basse: mélaminé chêne naturel / Portes armoire
basse: verre trempé satiné

Beine: Pulverbeschichtung Weiß / Tischplatten + Möbel
Eko + Sideboard: Melamin Eiche Natur / Türen Side-
board: mattiertes temperiertes Glas

Poten: wit gevefd epoxy / Bladen + meubel Eko + kast:
melamine eikenhout natuur / Kastdeuren: gesatineerd
gehard glas

Patas: barnizadas epoxi blanco / Sobres + mueble Eko
+ aparador: melamina roble natural / Puertas aparador
cristal templado satinado



**Gambe: verniciate epox bianco /
Piani: melaminico rovere naturale**

Legs: white epoxy paint finish /
Tops: natural oak laminate

Piètements: laqués epoxy blanc /
Plateaux: mélaminé chêne naturel

Beine: Pulverbeschichtung Weiß /
Tischplatten: Melamin Eiche Natur

Poten: wit gevefd epoxy /
Bladen: melamine eikenhout natuur

Patas: barnizadas epoxi blanco /
Sobres: melamina roble natural

winglet executive

Gambe: verniciate epox bianco / **Piani:** melaminico noce canaletto / **Cassettiera:** melaminico bianco / **Top e fianchi armadio:** melaminico noce canaletto / **Ante armadio:** melaminico noce canaletto e vetro temperato satinato

Legs: white epoxy paint finish / **Tops:** Canaletto walnut laminate / **Chest of drawers:** white laminate / **Closet top and sides:** Canaletto walnut laminate / **Closet doors:** Canaletto walnut laminate and satin-finished tempered glass

Piètements: laqués epoxy blanc / **Plateaux:** mélaminé noyer canaletto / **Caisson:** mélaminé blanc / **Top et côtés armoire:** mélaminé noyer canaletto / **Portes armoire:** mélaminé noyer canaletto et verre trempé satiné

Beine: Pulverbeschichtung Weiß / **Tischplatten:** Melamin Canaletto Nussbaum / **Container:** Melamin Weiß / **Abdeckplatte und Seiten Schrank:** Melamin Canaletto Nussbaum / **Türen Schrank:** Melamin Canaletto Nussbaum und mattiertes temperiertes Glas

Poten: wit geveerd epoxy / **Bladen:** melamine notenhout canaletto / **Ladekast:** wit melamine / **Top en zijpanelen kast:** melamine notenhout canaletto / **Kastdeuren:** melamine notenhout canaletto en gesatineerd gehard glas

Patas: barnizadas epoxi blanco / **Sobres:** melamina nogal canaletto / **Cajonera:** melamina blanco / **Encimera y costados armario:** melamina nogal canaletto / **Puertas armario:** melamina nogal canaletto y cristal templado satinado





**Colonna con base: verniciate epox bianco /
Piano: melaminico noce canaletto**

Column with base: white epoxy paint finish /
Top: Canaletto walnut laminate

Colonne avec base: laqués epoxy blanc /
Plateau: mélaminé noyer canaletto

Säule mit Fuß: Pulverbeschichtung Weiß /
Tischplatte: Melamin Canaletto Nussbaum

Kolom met basis: wit geveerd epoxy /
Blad: melamine notenhout canaletto

Columna con base: barnizadas epoxi blanco /
Sobre: melamina nogal canaletto



**Gambe: verniciate epox bianco / Piani: melaminico noce
canaletto / Cassetiera: melaminico bianco / Top e fianchi
armadio: melaminico noce canaletto / Ante armadio:
melaminico noce canaletto e vetro temperato satinato**

Legs: white epoxy paint finish / Tops: Canaletto walnut
laminate / Chest of drawers: white laminate / Closet top and
sides: Canaletto walnut laminate / Closet doors: Canaletto
walnut laminate and satin-finished tempered glass

Piètements: laqués epoxy blanc / Plateau: mélaminé noyer
canaletto / Caisson: mélaminé blanc / Top et côtés armoire:
mélaminé noyer canaletto / Portes armoire: mélaminé noyer
canaletto et verre trempé satiné

Beine: Pulverbeschichtung Weiß / Tischplatte: Melamin
Canaletto Nussbaum / Container: Melamin Weiß /
Abdeckplatte und Seiten Schrank: Melamin Canaletto
Nussbaum / Türen Schrank: Melamin Canaletto Nussbaum und
mattiertes temperiertes Glas

Poten: wit geveerd epoxy / Bladen: melamine notenhout
canaletto / Ladekast: wit melamine / Top en zijpanelen
kast: melamine notenhout canaletto / Kastdeuren: melamine
notenhout canaletto en gesatineerd gehard glas

Patas: barnizadas epoxi blanco / Sobres: melamina nogal
canaletto / Cajonera: melamina blanco / Encimera y
costados armario: melamina nogal canaletto / Puertas armario:
melamina nogal canaletto y cristal templado satinado



winglet[™] executive

Gambe: verniciate cromo lucido e epox bianco /
Piani + top e fianchi armadio: melaminico wengé
scuro / **Ante armadio:** melaminico wengé scuro e
vetro temperato satinato / **Cassettiera:** melaminico
bianco

Legs: polished chrome and white epoxy paint finish /
Closet shelves, top and sides: Dark wenge laminate /
Closet doors: Dark wenge laminate and satin-finished
glass / Chest of drawers: white laminate

Piètements: laqués chrome brillant et époxy blanc /
Plateaux + top et côtés armoire: mélaminé wengé foncé
/ Portes armoire: mélaminé wengé foncé et verre trempé
satiné / Caisson: mélaminé blanc

Beine: Glanzverchromt und Pulverbeschichtung Weiß /
Tischplatten + Abdeckplatte und Seiten Schrank: Melamin
Wengé dunkel / Türen Schrank: Melamin wengé dunkel
und mattiertes temperiertes Glas / Container: Melamin
Weiß

Poten: gevefd glanzend chroom en wit epoxy / Bladen
+ top en zijpanelen kast: melamine donker wengé /
Kastdeuren: melamine donker wengé en gesatineerd
gehard glas / Ladekast: wit melamine

Patas: barnizadas cromo brillante y epoxi blanco /
Sobres + encimera y costados armario: melamina wengé
oscuro / Puertas armario: melamina wengué oscuro y
cristal templado satinado / Cajonera: melamina blanco





Gambe: verniciate cromo lucido e epox bianco / **Piani + top e fianchi armadio:** melaminico wengé scuro / **Ante armadio:** melaminico wengé scuro e vetro temperato satinato / **Cassettiera:** melaminico bianco

Legs: polished chrome and white epoxy paint finish / Closet shelves, top and sides: Dark wenge laminate / Closet doors: Dark wenge laminate and satin-finished glass / Chest of drawers: white laminate

Piètements: laqués chrome brillant et époxy blanc / Plateaux + top et côtés armoire: mélaminé wengé foncé / Portes armoire: mélaminé wengé foncé et verre trempé satiné / Caisson: mélaminé blanc

Beine: Glanzverchromt und Pulverbeschichtung Weiß / Tischplatten + Abdeckplatte und Seiten Schrank: Melamin Wengé dunkel / Türen Schrank: Melamin wengé dunkel und mattiertes temperiertes Glas / Container: Melamin Weiß

Poten: gevefd glanzend chroom en wit epoxy / Bladen + top en zijpanelen kast: melamine donker wengé / Kast deuren: melamine donker wengé en gesatineerd gehard glas / Ladekast: wit melamine

Patas: barnizadas cromo brillante y epoxi blanco / Sobres + encimera y costados armario: melamina wengé oscuro / Puertas armario: melamina wengué oscuro y cristal templado satinado / Cajonera: melamina blanco



winglet
executive



Gambe: verniciate cromo lucido e epox bianco / **Piani:** melaminico wengé scuro / **Top access:** cromo lucido

Legs: polished chrome and white epoxy paint finish / Tops: dark wenge laminate / Top access: polished chrome finish

Piètements: laqués chrome brillant et époxy blanc / Plateaux: mélaminé wengé foncé / Top-access: chrome brillant

Beine: Glanzverchromt und Pulverbeschichtung Weiß / Tischplatten: Melamin Wengé dunkel / Top Access: Glanzverchromt

Poten: gevefd glanzend chroom en wit epoxy / Bladen: melamine donker wengé / Toegang bovenaan: glanzend chroom

Patas: barnizadas cromo brillante y epoxi blanco / Sobres: melamina wengé oscuro / Acceso superior: cromo brillante



winglet[™] executive

Gambe: verniciate epox bianco / Piani: melaminico bianco / Muretto e mobile con ante scorrevoli: melaminico bianco / Top, fianchi e ante armadi: melaminico bianco

Legs: white epoxy paint finish / Tops: white laminate / Wall and cabinet with sliding doors: white laminate / Closet top, sides and doors: white laminate

Piètements: laqués epoxy blanc / Plateaux: mélaminé blanc / Piètement plein et meuble avec portes coulissantes: mélaminé blanc / Top, côtés et portes armoires: mélaminé blanc

Beine: Pulverbeschichtung Weiß / Tischplatten: Melamin Weiß / Wange und Möbel mit Schiebetüren: Melamin Weiß / Abdeckplatte, Seiten und Türen Schränke: Melamin Weiß

Poten: wit geveerd epoxy / Bladen: wit melamine / Wand en meubel met schuifdeuren: wit melamine / Top, zijpanelen en kastdeuren: wit melamine

Patas: barnizadas epoxi blanco / Sobres: melamina blanco / Tabique y mueble con puertas correderas: melamina blanco / Encimera, costados y puertas armarios: melamina blanco





Gambe: verniciate epox bianco / Piani: melaminico bianco / Top, fianchi e ante armadi: melaminico bianco

Legs: white epoxy paint finish / Tops: white laminate / Closet top, sides and doors: white laminate

Piètements: laqués epoxy blanc / Plateaux: mélaminé blanc / Top, côtés et portes armoires: mélaminé blanc

Beine: Pulverbeschichtung Weiß / Tischplatten: Melamin Weiß / Abdeckplatte, Seiten und Türen Schränke: Melamin Weiß

Poten: wit gevefd epoxy / Blad: wit melamine / Top, zijpanelen en kastdeuren: wit melamine

Patas: barnizadas epoxi blanco / Sobres: melamina blanco / Encimera, costados y puertas armarios: melamina blanco



Gambe: verniciate epox bianco / Piano: melaminico bianco

Legs: white epoxy paint finish / Top: white laminate

Piètements: laqués epoxy blanc / Plateau: mélaminé blanc

Beine: Pulverbeschichtung Weiß / Tischplatte: Melamin Weiß

Poten: wit gevefd epoxy / Blad: wit melamine

Patas: barnizadas epoxi blanco / Sobre: melamina blanco



winglet[™]
operative

winglet[™] operative

Gambe: verniciate epox bianco / **Piani:** melaminico rovere naturale / **Cassettiere e vertical file:** melaminico bianco / **Schermi:** tessuto Lucia - Blu Martinique / **Top, fianchi e ante armadi:** melaminico bianco

Legs: white epoxy paint finish / **Tops:** natural oak laminate / **Chest of drawers and vertical file:** white laminate / **Screens:** Lucia fabric - Blue Martinique / **Closest top, sides and doors:** white laminate

Piètements: laqués epoxy blanc / **Plateaux:** mélaminé chêne naturel / **Caissons et classeur vertical:** mélaminé blanc / **Écrans:** tissu Lucia - Bleu Martinique / **Top, côtés et portes armoires:** mélaminé blanc

Beine: Pulverbeschichtung Weiß / **Tischplatten:** Melamin Eiche Natur / **Container und Vertical File:** Melamin Weiß / **Schirme:** Stoff Lucia - Blau Martinique / **Abdeckplatte, Seiten und Türen Schränke:** Melamin Weiß

Poten: wit gevefd epoxy / **Bladen:** melamine eikenhout natuur / **Ladekasten en hangmappen:** wit melamine / **Schermen:** stof Lucia - Blauw - Martinique / **Top, zijpanelen en kastdeuren:** wit melamine

Patas: barnizadas epoxi blanco / **Sobres:** melamina roble natural / **Cajoneras y archivador vertical:** melamina blanco / **Pantallas:** tejido Lucia - Azul Martinique / **Encimera, costados y puertas armarios:** melamina blanco





Gambe e passacavi: verniciati epox bianco / Piani: melaminico rovere naturale / Cassettiere: melaminico bianco / Schermi: tessuto Lucia - Mattone Jamaica

Legs and cable holders: white epoxy paint finish / Tops: natural oak laminate / Chest of drawers: white laminate / Screens: Lucia fabric - Jamaica brick colour

Piètements et passe-câbles: laqués epoxy blanc / Plateaux: mélaminé chêne naturel / Plateaux: mélaminé chêne naturel / Caissons: mélaminé blanc / Écrans: tissu Lucia - Brique Jamaica

Beine und Kabeldurchführungen: Pulverbeschichtung Weiß / Tischplatten: Melamin Eiche Natur / Container: Melamin Weiß / Schirme: Stoff Lucia - Ziegelrot Jamaica

Poten en kabeldoorvoer: wit geveerd epoxy / Bladen: melamine eikenhout natuur / Ladekasten: wit melamine / Schermen: stof Lucia - Baksteen - Jamaica

Patas y pasacables: barnizados epoxi blanco / Sobres: melamina roble natural / Cajoneras: melamina blanco / Pantallas: tejido Lucia - Pardo cobre Jamaica

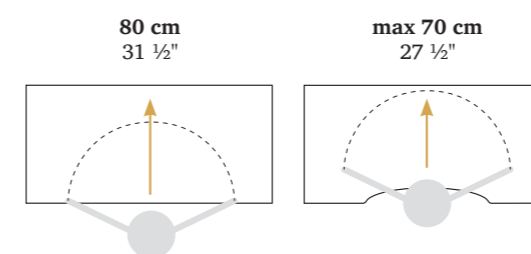

Scrivania

Desktop - Bureau - Schreibtisch - Schrijftafel - Escritorio

Scrivania ERGO

Ergo desktop - Bureau Ergo - Schreibtisch ERGO - Schrijftafel ERGO - Escritorio Ergo

Gambe: verniciate epox bianco / Piani: melaminico rovere naturale / Vertical file: melaminico bianco / Schermi: tessuto Lucia - Petrolio Windjammer / Top, fianchi e ante armadi: melaminico bianco

Legs: white epoxy paint finish / Tops: natural oak laminate / Vertical file: white laminate / Screens: Lucia fabric - Windjammer petroleum colour / Closet top, sides and doors: white laminate

Piètements: laqués epoxy blanc / Plateaux: mélaminé chêne naturel / Classeur vertical: mélaminé blanc / Écrans: tissu Lucia - Pétrole Windjammer / Top, côtés et portes armoires: mélaminé blanc

Beine: Pulverbeschichtung Weiß / Tischplatten: Melamin Eiche Natur / Vertical File: Melamin Weiß / Schirme: Stoff Lucia - Petroleum Blau Windjammer / Abdeckplatte, Seiten und Türen Schränke: Melamin Weiß

Poten: wit geveerd epoxy / Bladen: melamine eikenhout natuur / Hangmappen: wit melamine / Schermen: stof Lucia - Petroleum - Windjammer / Top, zijpanelen en kastdeuren: wit melamine

Patas: barnizadas epoxi blanco / Sobres: melamina roble natural / Archivador vertical: melamina blanco / Pantallas: tejido Lucia - Petróleo Windjammer / Encimera, costados y puertas armarios: melamina blanco

winglet[™] operative

Gambe: verniciate epox bianco / **Piani:** melaminico bianco / **Schermi:** tessuto Xpress - Giallo Primavera e Lucia - Celeste Arcibo / **Scocca e top armadi:** melaminico bianco / **Ante armadi:** melaminico tortora / **Vertical file:** melaminico bianco

Legs: white epoxy paint finish / **Tops:** white laminate / **Screens:** Xpress fabric - Spring yellow and Lucia - Arcibo light blue / **Closet body and top:** white laminate / **Closet doors:** turtledove laminate / **Vertical file:** white laminate

Piètements: laqués epoxy blanc / **Plateaux:** mélaminé blanc / **Écrans:** tissu Xpress - Jaune Printemps et Lucia - Bleu ciel Arcibo / **Structure et top armoires:** mélaminé blanc / **Portes armoires:** mélaminé tourterelle / **Classeur vertical:** mélaminé blanc

Beine: Pulverbeschichtung Weiß / **Tischplatten:** Melamin Weiß / **Schirme:** Stoff Xpress - Frühling Gelb und Lucia - Hellblau Arcibo / **Unterbau und Abdeckplatte Schränke:** Melamin Weiß / **Türen Schränke:** Melamin Turteltaube / **Vertical File:** Melamin Weiß

Poten: wit geverfd epoxy / **Bladen:** wit melamine / **Schermen:** stof Xpress - Lentegeel en Lucia - Hemelsblauw - Arcibo / **Frame en top kasten:** wit melamine / **Kastdeuren:** melamine tortelduif / **Hangmappen:** wit melamine

Patas: barnizadas epoxi blanco / **Sobres:** melamina blanco / **Pantallas:** tejido Xpress - Amarillo Primavera y Lucia - Celeste Arcibo / **Armazón y encimera armarios:** melamina blanco / **Puertas armarios:** melamina tortola / **Archivador vertical:** melamina blanco



winglet operative



Gambe: verniciate epox bianco / **Piani, modesty panel e cassettiere:** melaminico bianco / **Schermi:** laccato opaco tortora e tessuto Xpress - Verde sottobosco / **Ubi:** melaminico bianco / **Ante Ubi:** metacrilato grigio

Legs: white epoxy paint finish / **Tops, modesty panel and chest of drawers:** white laminate / **Screens:** matte lacquered turtledove colour and Xpress fabric - Underbush green / **Ubi:** white laminate / **Ubi doors:** grey methacrylate

Piètements: laqués epoxy blanc / **Plateaux, voile de fond et caissons:** mélaminé blanc / **Écrans:** laqué mat tourterelle et tissu Xpress - Vert sous-bois / **Ubi:** mélaminé blanc / **Portes Ubi:** méthacrylate gris

Beine: Pulverbeschichtung Weiß / **Tischplatten, Knieraumblende und Container:** Melamin Weiß / **Schirme:** Mattweiß lackiert Turteltaube und Stoff Xpress - Unterholz Grün / **Ubi:** Melamin Weiß / **Türen Ubi:** Methacrylat Grau

Poten: wit geveerd epoxy / **Bladen, knieschotten en ladekasten:** wit melamine / **Schermen:** mat gelakt tortelduif en stof Xpress - Bosgrond-groen / **Ubi:** wit melamine / **Deuren Ubi:** grijs methacrylaat

Patas: barnizadas epoxi blanco / **Sobres, panel frontal y cajoneras:** melamina blanco / **Pantallas:** lacado mate tortola y tejido Xpress - Verde sotobosque / **Ubi:** melamina blanco / **Puertas Ubi:** metacrilato gris



winglet operative

Gambe: verniciate epox bianco / **Piani:** melaminico bianco / **Cassettiere, vertical file e mobile con ante scorrevoli:** melaminico bianco / **Armadi:** melaminico bianco / **Schermi:** tessuto Stay - Blu Avio

Legs: white epoxy paint finish / **Tops:** white laminate / **Chests of drawers, vertical files and cabinet with sliding doors:** white laminate / **Closets:** white laminate / **Screens:** Stay fabric - Avio blue

Piètements: laqués epoxy blanc / **Plateaux:** mélaminé blanc / **Caissons, classeur vertical et meuble avec portes coulissantes:** mélaminé blanc / **Armoires:** mélaminé blanc / **Écrans:** tissu Stay - Blu Aviation

Beine: Pulverbeschichtung Weiß / **Tischplatten:** Melamin Weiß / **Container, Vertical File und Möbel mit Schiebetüren:** Melamin Weiß / **Schränke:** Melamin Weiß / **Schirme:** Stoff Stay - Avio Blau

Poten: wit geveerd epoxy / **Bladen:** wit melamine / **Ladekasten, hangmappen en meubel met schuifdeuren:** wit melamine / **Kasten:** wit melamine / **Schermen:** stof Stay - Avio-blauw

Patas: barnizadas epoxi blanco / **Sobres:** melamina blanco / **Cajoneras, archivador vertical y mueble con puertas correderas:** melamina blanco / **Armarios:** melamina blanco / **Pantallas:** tejido Stay - Azul colombino



Gambe: verniciate epox bianco / **Piani:** melaminico bianco / **Schermi:** tessuto Stay - Blu Avio

Legs: white epoxy paint finish / Tops: white laminate / Screens: Stay fabric - Avio blue

Piètements: laqués epoxy blanc / Plateaux: mélaminé blanc / Écrans: tissu Stay - Blu Aviation

Beine: Pulverbeschichtung Weiß / Tischplatten: Melamin Weiß / Schirme: Stoff Stay - Avio Blau

Poten: wit gevefd epoxy / Bladen: wit melamine / Schermen: stof Stay - Avio-blauw

Patas: barnizadas epoxi blanco / Sobres: melamina blanco / Pantallas: tejido Stay - Azul colombino

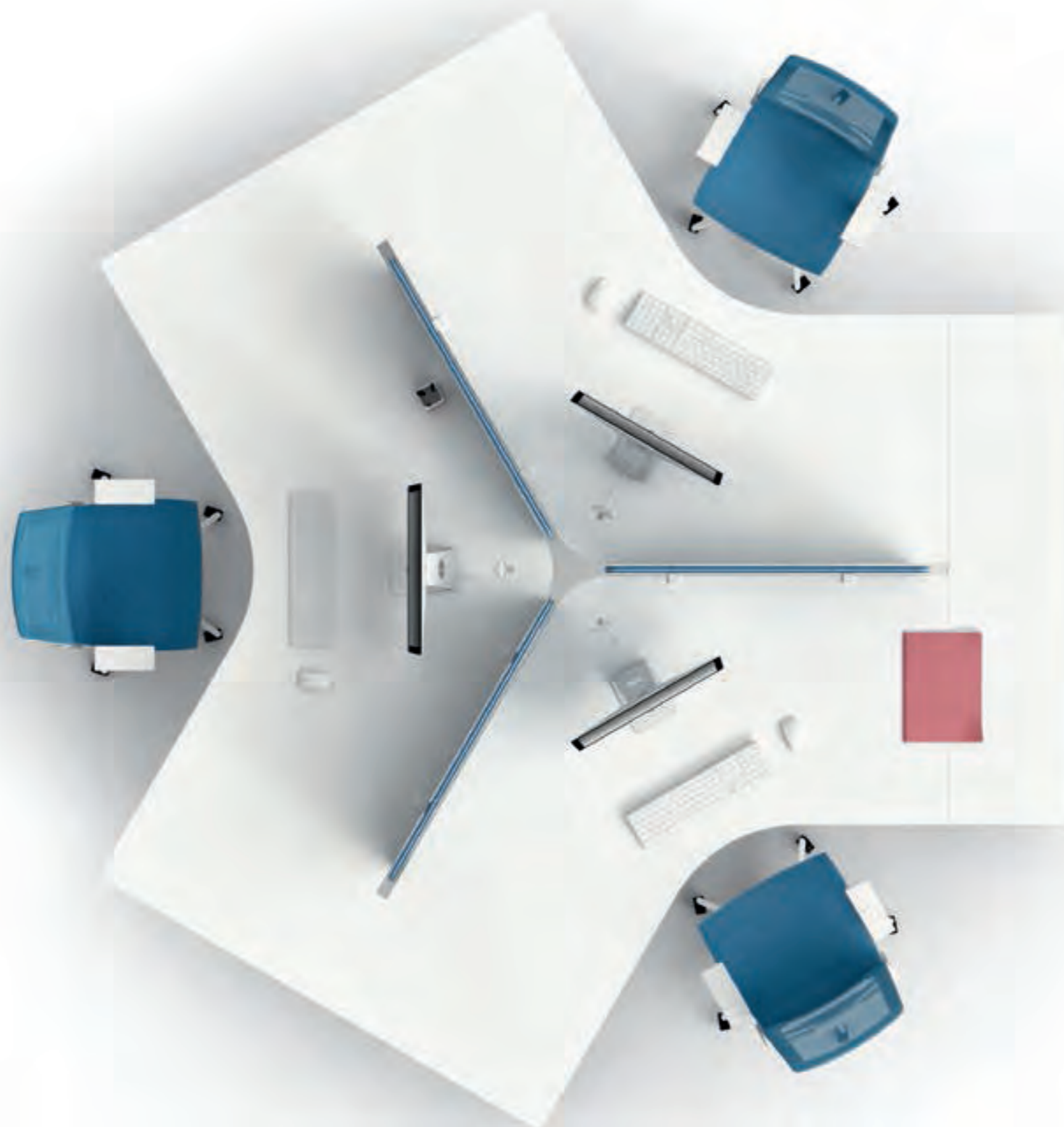

winglet[™] operative

Gambe: verniciate epox bianco / **Piani:** melaminico bianco / **Mobili Eko e armadi:** melaminico bianco / **Schermo:** tessuto Xpress - Giallo primavera

Legs: white epoxy paint finish / Tops: white laminate / Eko cabinets and closets: white laminate / Screen: Xpress fabric - Spring yellow

Piètements: laqués epoxy blanc / Plateaux: mélaminé blanc / Meubles Eko et armoires: mélaminé blanc / Écrans: tissu Xpress - Jaune printemps

Beine: Pulverbeschichtung Weiß / Tischplatten: Melamin Weiß / Möbel Eko und Schränke: Melamin Weiß / Schirm: Stoff Xpress - Frühling Gelb

Poten: wit gevefd epoxy / Bladen: wit melamine / Meubels Eko en kasten: wit melamine / Scherm: stof Xpress - Lentgeel

Patas: barnizadas epoxi blanco / Sobres: melamina blanco / Muebles Eko y armarios: melamina blanco / Pantalla: tejido Xpress - Amarillo primavera



winglet[™] operative

Gambe: verniciate epox bianco / **Piani, cassettiere e vertical file:** melaminico bianco / **Schermi:** tessuto Lucia - Celeste Arecibo e Xpress - Giallo Primavera / **Scocca e top armadi:** melaminico bianco / **Ante mobili e armadi:** melaminico tortora

Legs: white epoxy paint finish / Tops, chests of drawers and vertical file: white laminate / Screens: Lucia fabric - Arecibo light blue and Xpress - Spring yellow / Closet body and top: white laminate / Cabinet and closet doors: turtledove laminate

Prètements: laqués epoxy blanc / Plateaux, caissons et classeur vertical: mélaminé blanc / Écrans: tissu Lucia - Bleu Arecibo et Xpress - Jaune Printemps / Structure et top armoires: mélaminé blanc / Portes meubles et armoires: mélaminé tourterelle

Beine: Pulverbeschichtung Weiß / Tischplatten, Container und Vertical File: Melamin Weiß / Schirme: Stoff Lucia - Hellblau Arecibo und Xpress - Frühling Gelb / Unterbau und Abdeckplatte Schränke: Melamin Weiß / Türen Möbel und Schränke: Melamin Turteltaube

Poten: wit geveerd epoxy / Bladen, ladekasten en hangmappen: wit melamine / Schermen: stof Lucia - Hemelsblau - Arecibo en Xpress - Lentegeel / Deuren meubels en kasten: melamine tortelduif

Patas: barnizadas epoxi blanco / Sobres, cajoneras y archivador vertical: melamina blanco / Pantallas: tejido Lucia - Celeste Arecibo y Xpress - Amarillo Primavera / Armazón y encimera armarios: melamina blanco / Puertas muebles y armarios: melamina tortola





Gambe: verniciate epox bianco / Piani, cassettiere e vertical file: melaminico bianco / Schermi: tessuto Lucia - Celeste Arcibo / Mobili con ante scorrevoli: melaminico bianco e tortora

Legs: white epoxy paint finish / Tops, chests of drawers and vertical file: white laminate / Screens: Lucia fabric - Arcibo light blue / Cabinet with sliding doors: white and turtledove laminate

Piètements: laqués epoxy blanc / Plateaux, caissons et classeur vertical: mélaminé blanc / Écrans: tissu Lucia - Bleu ciel Arcibo / meuble avec portes coulissantes: mélaminé blanc et tourterelle

Beine: Pulverbeschichtung Weiß / Tischplatten, Container und Vertical File: Melamin Weiß / Schirme: Stoff Lucia - Hellblau Arcibo / Möbel mit Schiebetüren: Melamin Weiß und Turteltaube

Poten: wit gevefd epoxy / Bladen, ladekasten en hang-mappen: wit melamine / Schermen: stof Lucia - Hemelsblauw - Arcibo / Meubel met schuifdeuren: wit en tortelduif melamine

Patatas: barnizadas epoxi blanco / Sobres, cajoneras y archivador vertical: : melamina blanco / Pantallas: tejido Lucia - Celeste Arcibo / Mueble con puertas correderas: melamina blanco y tortola

Gambe: verniciate epox bianco / Piani e cassettiere: melaminico bianco / Schermi: tessuto Lucia - Celeste Arcibo

Legs: white epoxy paint finish / Tops and chests of drawers: white laminate / Screens: Lucia fabric - Arcibo light blue

Piètements: laqués epoxy blanc / Plateaux et caissons: mélaminé blanc / Écrans: tissu Lucia - Bleu ciel Arcibo

Beine: Pulverbeschichtung Weiß / Tischplatten und Container: Melamin Weiß / Schirme: Stoff Lucia - Hellblau Arcibo

Poten: wit gevefd epoxy / Bladen en ladekasten: wit melamine / Schermen: stof Lucia - Hemelsblauw - Arcibo

Patatas: barnizadas epoxi blanco / Sobres y cajoneras: melamina blanco / Pantallas: tejido Stay - Azul colombino



winglet™ operative

Gambe: verniciate epox bianco / **Piani:** melaminico bianco / **Muretto, M10 e vertical file:** melaminico bianco / **Schermi:** tessuto Puma – Grigio scuro

Legs: white epoxy paint finish / Tops: white laminate / Wall, M10 and vertical file: white laminate / Screens: Puma fabric - Dark grey

Piètements: laqués epoxy blanc / Plateaux: mélaminé blanc / Piètement plein, M10 et classeur vertical: mélaminé blanc / Écrans: tissu Puma – Gris foncé

Beine: Pulverbeschichtung Weiß / Tischplatten: Melamin Weiß / Wange, M10 und Vertical File: Melamin Weiß / Schirme: Stoff Puma – Dunkelgrau

Poten: wit gevefd epoxy / Bladen: wit melamine / Wand, M10 en hangmappen: wit melamine / Schermen: stof Puma – Donkergrijs

Patas: barnizadas epoxi blanco / Sobres: melamina blanco / Tabique, M10 y archivador vertical: melamina blanco / Pantallas: tejido Puma – Gris oscuro

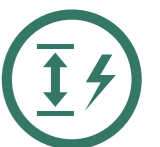

winglet operative

Gambe: verniciate epox bianco / Piani: melaminico bianco / Pannello laterale e M10: melaminico bianco / Schermi: tessuto Xpress - Giallo primavera

Legs: white epoxy paint finish / Tops: white laminate / Side panel and M10: white laminate / Screens: Xpress fabric - Spring yellow

Piètements: laqués epoxy blanc / Plateaux: mélaminé blanc / Panneau latéral et M10: mélaminé blanc / Écrans: tissu Xpress - Jaune printemps

Beine: Pulverbeschichtung Weiß / Tischplatten: Melamin Weiß / Seitenpaneel und M10: Melamin Weiß / Schirme: Stoff Xpress - Frühling Gelb

Poten: wit geverfd epoxy / Bladen: wit melamine / Zijpaneel en M10: wit melamine / Schermen: stof Xpress - Lentegel

Patas: barnizadas epoxi blanco / Sobres: melamina blanco / Tablero lateral y M10: melamina blanco / Pantallas: tejido Xpress - Amarillo primavera

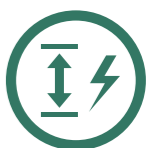

winglet[™] operative

Gambe: verniciate epox bianco / **Piani:** melaminico rovere naturale / **Muretto e vertical file:** melaminico bianco / **Schermi:** tessuto Lucia – Blu Martinique

Legs: white epoxy paint finish / Tops: natural oak laminate / Wall and vertical file: white laminate / Screens: Lucia fabric - Martinique blue

Piètements: laqués epoxy blanc / Plateaux: mélaminé chêne naturel / Piètement plein et classeur vertical: mélaminé blanc / Écrans: tissu Lucia – Bleu Martinique

Beine: Pulverbeschichtung Weiß / Tischplatten: Melamin Eiche Natur / Wange und Vertical File: Melamin Weiß / Schirme: Stoff Lucia – Blau Martinique

Poten: wit gevefd epoxy / Bladen: melamine eikenhout natuur / Wand en hangmappen: wit melamine / Schermen: stof Lucia – Blauw - Martinique

Patas: barnizadas epoxi blanco / Sobres: melamina roble natural / Tabique y archivador vertical: melamina blanco / Pantallas: tejido Lucia – Azul Martinique

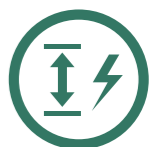

winglet[™]
meeting

Gambe: verniciate epox bianco / **Piani, top e fianchi armadio:** melaminico rovere naturale / **Ante armadio:** melaminico rovere naturale e vetro temperato satinato

Legs: white epoxy paint finish / Closet shelves, top and sides: natural oak laminate / Closet doors: natural oak laminate and satin-finished tempered glass

Piètements: laqués epoxy blanc / Plateaux, top et côtés armoire: mélaminé chêne naturel / Portes armoire: mélaminé chêne naturel et verre trempé satiné

Beine: Pulverbeschichtung Weiß / Tischplatten, Abdeckplatte und Seiten Schrank: Melamin Eiche Natur / Türen Schrank: Melamin Eiche Natur und mattiertes temperiertes Glas

Poten: wit geveerd epoxy / Bladen, top en zijpanelen kast: melamine eikenhout natuur / Kastdeuren: melamine eikenhout natuur en gesatineerd gehard glas

Patas: barnizadas epoxi blanco / Sobres, encimera y costados armario: melamina roble natural / Puertas armario: melamina roble natural y cristal templado satinado



**Gambe: verniciate epox bianco / Piani, top e fianchi
armadio: melaminico bianco / Ante armadio: melaminico bianco e vetro temperato satinato**

Legs: white epoxy paint finish / Closet shelves, top and sides: white laminate / Closet doors: white laminate and satin-finished tempered glass

Piètements: laqués epoxy blanc / Plateaux, top et côtés
armoire: mélaminé blanc / Portes armoire: mélaminé blanc et verre trempé satiné

Beine: Pulverbeschichtung Weiß / Tischplatten, Abdeckplatte und Seiten Schrank: Melamin Weiß / Türen Schrank: Melamin Weiß und mattiertes temperiertes Glas

Poten: wit geveerd epoxy / Bladen, top en zijpanelen
kast: wit melamine / Kastdeuren: wit melamine en gesatineerd gehard glas

Patas: barnizadas epoxi blanco / Sobres, encimera y costados armario: melamina blanco / Puertas armario: melamina blanco y cristal templado satinado



Gambe: verniciate epox bianco / **Piani:** melaminico bianco / **Flipper:** melaminico bianco

Legs: white epoxy paint finish / Tops: white laminate / Flipper: white laminate

Piètements: laqués epoxy blanc / Plateaux: mélaminé blanc / Flipper: mélaminé blanc

Beine: Pulverbeschichtung Weiß / Tischplatten: Melamin Weiß / Flipper: Melamin Weiß

Poten: wit geverfd epoxy / Bladen: wit melamine / Flipper: wit melamine

Patas: barnizadas epoxi blanco / Sobres: melamina blanco / Flipper: melamina blanco





**Gambe: verniciate epox bianco /
Piani: melaminico bianco**

Legs: white epoxy paint finish /
Tops: white laminate

Piètements: laqués epoxy blanc /
Plateaux: mélaminé blanc

Beine: Pulverbeschichtung Weiß /
Tischplatten: Melamin Weiß

Poten: wit gevefd epoxy /
Bladen: wit melamine

Patas: barnizadas epoxi blanco /
Sobres: melamina blanco

**Gambe: verniciate epox bianco /
Piani: melaminico bianco**

Legs: white epoxy paint finish /
Tops: white laminate

Piètements: laqués epoxy blanc /
Plateaux: mélaminé blanc

Beine: Pulverbeschichtung Weiß /
Tischplatten: Melamin Weiß

Poten: wit gevefd epoxy /
Bladen: wit melamine

Patas: barnizadas epoxi blanco /
Sobres: melamina blanco



**Comunicare, condividere,
partecipare.**

Communicating, sharing,
participating.

Communiquer, partager,
participer.

Kommunizieren, teilen,
teilnehmen.

Communiceren, delen,
deelnemen.

Comunicar, compartir,
participar.



Alcuni esempi di possibili configurazioni - Some examples of possible layouts - Voici quelques exemples de configurations possibles - Einige Beispiele von möglichen Konfigurationen - Een aantal voorbeelden van mogelijke configuraties - Algunos ejemplos de configuraciones posibles

Per una più completa visione della collezione, consultare il listino
Pour un meilleur aperçu de la collection, veuillez consulter la liste des prix
Om de volledige collectie te raadplegen, zie de lijst

To view the collection in more detail, please refer to our price list
Eine komplette Ansicht der Kollektion finden Sie in der Preisliste
Para ver más detalladamente la colección, consultar la tarifa

		cm	inch
	Scrivania Desk Bureau Schreibtisch Bureau Escritorio	L. 80÷200 P. 60÷80 H. 74	W. 31 1/2"÷78 3/4" D. 23 3/4"÷31 1/2" H. 29"
	Scrivania Desk Bureau Schreibtisch Bureau Escritorio	L. 160÷200 P. 80 H. 74	W. 63"÷78 3/4" D. 31 1/2" H. 29"
	Scrivania Desk Bureau Schreibtisch Bureau Escritorio	L. 180 P. 90 H. 74	W. 70 3/4" D. 35 1/2" H. 29"
	Scrivania con cassetiera portante CM.0408.M4 Desk with drawer unit CM.0408.M4 Bureau avec caisson portant CM.0408.M4 Schreibtisch mit tragendem Schubladenelement CM.0408.M4 Bureau met dragend ladenblok CM0408M4 Escritorio con cajonera portante CM.0408.M4	L. 120÷200 P. 60÷80 H. 74	W. 47 1/4"÷78 3/4" D. 23 3/4"÷31 1/2" H. 29"
	Scrivania con cassetiera portante CM.0408.M3 Desk with drawer unit CM.0408.M3 Bureau avec caisson portant CM.0408.M3 Schreibtisch mit tragendem Schubladenelement CM.0408.M3 Bureau met dragend ladenblok CM0408M3 Escritorio con cajonera portante CM.0408.M3	L. 120÷200 P. 60÷80 H. 74	W. 47 1/4"÷78 3/4" D. 23 3/4"÷31 1/2" H. 29"
	Scrivania con vertical file Sx CM.0408.ES Desk with left vertical file CM.0408.ES Bureau avec classeurs verticaux gauche CM.0408.ES Schreibtisch mit Vertical File links CM.0408.ES Bureau met vertical file links CM.0408.ES Escritorio con archivadores verticales izquierdo CM.0408.ES	L. 120÷200 P. 60÷80 H. 74	W. 47 1/4"÷78 3/4" D. 23 3/4"÷31 1/2" H. 29"
	Scrivania con vertical file Sx CM.1108.ES e top Desk with left vertical file CM.1108.ES and top Bureau avec classeurs verticaux gauche CM.1108.ES et dessus Schreibtisch mit Vertical File links CM.1108.ES und Top Bureau met vertical file links CM.1108.ES en top Escritorio con archivadores verticales izquierdo CM.1108.ES y sobre	L. 80÷200 P. 80 H. 74	W. 31 1/2"÷78 3/4" D. 31 1/2" H. 29"







		cm	inch
	Scrivania a ponte su mobile di servizio scorrevole Bridge desk on service cabinet Bureau pont sur meuble de service Schreibtisch-Brücke auf Werkboxmodul Brugtafel op dienstmeubel Escritorio puente en mueble de servicio	L. 120÷200 P. 142 H. 74	W. 47 1/4"÷78 3/4" D. 56" H. 29"
	Scrivania a ponte su mobile di servizio Eko BD.1206.C3 Bridge desk on service cabinet EKO BD.1206.C3 Bureau pont sur meuble de service EKO BD.1206.C3 Schreibtisch-Brücke auf Werkboxmodul EKO BD.1206.C3 Brugtafel op dienstmeubel EKO BD.1206.C3 Escritorio puente en mueble de servicio EKO BD.1206.C3	L. 120÷200 P. 142 H. 74	W. 47 1/4"÷78 3/4" D. 56" H. 29"
	Scrivania + dattilo appeso Desk + workwall Bureau + dactylo suspendu Schreibtisch + Hängender Tischmodul Bureau + oplegtafel Escritorio + ala escritorio suspendida	L. 140÷180 P. 160÷200 H. 74	W. 55"÷70 3/4" D. 63"÷78 3/4" H. 29"
	Scrivania + dattilo appeso con cassetiera portante CM.0407.M4 Desk + workwall with drawer unit CM.0407.M4 Bureau + dactylo suspendu avec caisson portant CM.0407.M4 Schreibtisch + Hängender Tischmodul mit tragendem Schubladenelement CM.0407.M4 Bureau + oplegtafel met dragend ladenblok CM.0407.M4 Escritorio + ala escritorio suspendida con cajonera portante CM.0407.M4	L. 140÷180 P. 160÷200 H. 74	W. 55"÷70 3/4" D. 63"÷78 3/4" H. 29"
	Scrivania Desk Bureau Schreibtisch Bureau Escritorio	L. 80÷180 P. 60÷80 H. 74	W. 31 1/2"÷78 3/4" D. 23 3/4"÷31 1/2" H. 29"
	Scrivania Desk Bureau Schreibtisch Bureau Escritorio	L. 160÷180 P. 80 H. 74	W. 63"÷70 3/4" D. 31 1/2" H. 29"
	Scrivania Desk Bureau Schreibtisch Bureau Escritorio	L. 180 P. 90 H. 74	W. 70 3/4" D. 35 1/2" H. 29"

Alcuni esempi di possibili configurazioni - Some examples of possible layouts - Voici quelques exemples de configurations possibles - Einige Beispiele von möglichen Konfigurationen - Een aantal voorbeelden van mogelijke configuraties - Algunos ejemplos de configuraciones posibles

Per una più completa visione della collezione, consultare il listino
Pour un meilleur aperçu de la collection, veuillez consulter la liste des prix
Om de volledige collectie te raadplegen, zie de lijst

To view the collection in more detail, please refer to our price list
Eine komplette Ansicht der Kollektion finden Sie in der Preisliste
Para ver más detalladamente la colección, consultar la tarifa

		cm	inch
	Scrivania con cassettiera portante CM.0408.M4 Desk with drawer unit CM.0408.M4 Bureau avec caisson portant CM.0408.M4 Schreibtisch mit tragendem Schubladenelement CM.0408.M4 Bureau met dragend ladenblok CM.0408.M4 Escritorio con cajonera portante CM.0408.M4	L. 120÷200 P. 60÷80 H. 74	W. 47 1/4"÷78 3/4" D. 23 3/4"÷31 1/2" H. 29"
	Scrivania con cassettiera portante CM.0408.M3 Desk with drawer unit CM.0408.M3 Bureau avec caisson portant CM.0408.M3 Schreibtisch mit tragendem Schubladenelement CM.0408.M3 Bureau met dragend ladenblok CM.0408.M3 Escritorio con cajonera portante CM.0408.M3	L. 120÷200 P. 60÷80 H. 74	W. 47 1/4"÷78 3/4" D. 23 3/4"÷31 1/2" H. 29"
	Scrivania con vertical file Sx CM.0408.ES Desk with left vertical file CM.0408.ES Bureau avec classeurs verticaux gauche CM.0408.ES Schreibtisch mit Vertical File links CM.0408.ES Bureau met vertical file links CM.0408.ES Escritorio con archivadores verticales izquierdo CM.0408.ES	L. 120÷200 P. 60÷80 H. 74	W. 47 1/4"÷78 3/4" D. 23 3/4"÷31 1/2" H. 29"
	Scrivania con vertical file Sx CM.1108.ES e top Desk with left vertical file CM.1108.ES and top Bureau avec classeurs verticaux gauche CM.1108.ES et dessus Schreibtisch mit Vertical File links CM.1108.ES und Top Bureau met vertical file links CM.1108.ES en top Escritorio con archivadores verticales izquierdo CM.1108.ES y sobre	L. 80÷200 P. 80 H. 74	W. 31 1/2"÷78 3/4" D. 31 1/2" H. 29"
	Scrivania a ponte su mobile di servizio scorrevole Bridge desk on service cabinet Bureau pont sur meuble de service Schreibtisch-Brücke auf Werkboxmodul Brugtafel op dienstmeubel Escritorio puente en mueble de servicio	L. 120÷180 P. 142 H. 74	W. 47 1/4"÷70 3/4" D. 56" H. 29"
	Scrivania a ponte su mobile di servizio Eko BD.1206.C3 Bridge desk on service cabinet EKO BD.1206.C3 Bureau pont sur meuble de service EKO BD.1206.C3 Schreibtisch-Brücke auf Werkboxmodul EKO BD.1206.C3 Brugtafel op dienstmeubel EKO BD.1206.C3 Escritorio puente en mueble de servicio EKO BD.1206.C3	L. 120÷180 P. 142 H. 74	W. 47 1/4"÷70 3/4" D. 56" H. 29"
	Scrivania + dattilo appeso Desk + workwall Bureau + dactylo suspendu Schreibtisch + Hängender Tischmodul Bureau + oplegtafel Escritorio + ala escritorio suspendida	L. 140÷180 P. 160÷200 H. 74	W. 55"÷70 3/4" D. 63"÷78 3/4" H. 29"

		cm	inch
	Scrivania + dattilo appeso con cassettiera portante CM.0407.M4 Desk + workwall with drawer unit CM.0407.M4 Bureau + dactylo suspendu avec caisson portant CM.0407.M4 Schreibtisch + Hängender Tischmodul mit tragendem Schubladenelement CM.0407.M4 Bureau + oplegtafel met dragend ladenblok CM.0407.M4 Escritorio + ala escritorio suspendida con cajonera portante CM.0407.M4	L. 140÷180 P. 160÷200 H. 74	W. 55"÷70 3/4" D. 63"÷78 3/4" H. 29"
	Scrivania 120° Desk 120° Bureau 120° Schreibtisch 120° Bureau 120° Escritorio 120°	L. 208 P. 126 H. 74	W. 81 3/4" D. 49 3/4" H. 29"
	Scrivania 135° Desk 135° Bureau 135° Schreibtisch 135° Bureau 135° Escritorio 135°	L. 177 P. 113 H. 74	W. 69 3/4" D. 44 1/2" H. 29"
	Scrivania Desk Bureau Schreibtisch Bureau Escritorio	L. 80÷200 P. 60÷80 H. 65÷85	W. 31 1/2"÷78 3/4" D. 23 3/4"÷31 1/2" H. 25 1/2"÷33 1/2"
	Scrivania Desk Bureau Schreibtisch Bureau Escritorio	L. 160÷200 P. 80 H. 65÷85	W. 63"÷78 3/4" D. 31 1/2" H. 25 1/2"÷33 1/2"
	Scrivania Desk Bureau Schreibtisch Bureau Escritorio	L. 180 P. 90 H. 65÷85	W. 70 3/4" D. 35 1/2" H. 25 1/2"÷33 1/2"
	Scrivania + dattilo appeso Desk + workwall Bureau + dactylo suspendu Schreibtisch + Hängender Tischmodul Bureau + oplegtafel Escritorio + ala escritorio suspendida	L. 140÷180 P. 160÷200 H. 65÷85	W. 55"÷70 3/4" D. 63"÷78 3/4" H. 25 1/2"÷33 1/2"

Alcuni esempi di possibili configurazioni - Some examples of possible layouts - Voici quelques exemples de configurations possibles - Einige Beispiele von möglichen Konfigurationen - Een aantal voorbeelden van mogelijke configuraties - Algunos ejemplos de configuraciones posibles

Per una più completa visione della collezione, consultare il listino
Pour un meilleur aperçu de la collection, veuillez consulter la liste des prix
Om de volledige collectie te raadplegen, zie de lijst

To view the collection in more detail, please refer to our price list
Eine komplette Ansicht der Kollektion finden Sie in der Preisliste
Para ver más detalladamente la colección, consultar la tarifa

		cm	inch
	Scrivania Desk Bureau Schreibtisch Bureau Escritorio	L. 80÷180 P. 60÷80 H. 65÷85	W. 31 1/2"÷70 3/4" D. 23 3/4"÷31 1/2" H. 25 1/2"÷33 1/2"
	Scrivania Desk Bureau Schreibtisch Bureau Escritorio	L. 160÷180 P. 80 H. 65÷85	W. 63"÷70 3/4" D. 31 1/2" H. 25 1/2"÷33 1/2"
	Scrivania Desk Bureau Schreibtisch Bureau Escritorio	L. 180 P. 90 H. 65÷85	W. 70 3/4" D. 35 1/2" H. 25 1/2"÷33 1/2"
	Scrivania + dattilo appeso Desk + workwall Bureau + dactylo suspendu Schreibtisch + Hängender Tischmodul Bureau + oplettafel Escritorio + ala escritorio suspendida	L. 140÷180 P. 160÷200 H. 65÷85	W. 55"÷70 3/4" D. 63"÷78 3/4" H. 25 1/2"÷33 1/2"
	Scrivania 120° Desk 120° Bureau 120° Schreibtisch 120° Bureau 120° Escritorio 120°	L. 208 P. 126 H. 65÷85	W. 81 3/4" D. 49 3/4" H. 25 1/2"÷33 1/2"
	Scrivania 135° Desk 135° Bureau 135° Schreibtisch 135° Bureau 135° Escritorio 135°	L. 176,6 P. 113,2 H. 65÷85	W. 69 1/2" D. 44 1/2" H. 25 1/2"÷33 1/2"
	Scrivania Desk Bureau Schreibtisch Bureau Escritorio	L. 140÷180 P. 80 H. 65÷85	W. 55"÷70 3/4" D. 31 1/2" H. 25 1/2"÷33 1/2"







		cm	inch
	Scrivania Desk Bureau Schreibtisch Bureau Escritorio	L. 160÷180 P. 80 H. 65÷85	W. 63"÷70 3/4" D. 31 1/2" H. 25 1/2"÷33 1/2"
	Scrivania Desk Bureau Schreibtisch Bureau Escritorio	L. 180 P. 90 H. 65÷85	W. 70 3/4" D. 35 1/2" H. 25 1/2"÷33 1/2"
	Scrivania + dattilo appeso Desk + workwall Bureau + dactylo suspendu Schreibtisch + Hängender Tischmodul Bureau + oplettafel Escritorio + ala escritorio suspendida	L. 140÷180 P. 160÷200 H. 65÷85	W. 55"÷70 3/4" D. 63"÷78 3/4" H. 25 1/2"÷33 1/2"
	Scrivania Desk Bureau Schreibtisch Bureau Escritorio	L. 140÷180 P. 80 H. 65÷130	W. 55"÷70 3/4" D. 31 1/2" H. 25 1/2"÷51"
	Scrivania Desk Bureau Schreibtisch Bureau Escritorio	L. 140÷180 P. 80 H. 65÷130	W. 55"÷70 3/4" D. 31 1/2" H. 25 1/2"÷51"
	Scrivania bench Desk bench Bureau bench Schreibtisch bench Bureau bench Escritorio bench	L. 140÷180 P. 164 H. 65÷85	W. 55"÷70 3/4" D. 64 1/2" H. 25 1/2"÷33 1/2"
	Scrivania bench Desk bench Bureau bench Schreibtisch bench Bureau bench Escritorio bench	L. 140÷180 P. 164 H. 65÷85	W. 55"÷70 3/4" D. 64 1/2" H. 25 1/2"÷33 1/2"

Alcuni esempi di possibili configurazioni - Some examples of possible layouts - Voici quelques exemples de configurations possibles - Einige Beispiele von möglichen Konfigurationen - Een aantal voorbeelden van mogelijke configuraties - Algunos ejemplos de configuraciones posibles

Per una più completa visione della collezione, consultare il listino
Pour un meilleur aperçu de la collection, veuillez consulter la liste des prix
Om de volledige collectie te raadplegen, zie de lijst

To view the collection in more detail, please refer to our price list
Eine komplette Ansicht der Kollektion finden Sie in der Preisliste
Para ver más detalladamente la colección, consultar la tarifa

		cm	inch
	Scrivanía bench Desk bench Bureau bench Schreibtisch bench Bureau bench Escritorio bench	L. 140÷180 P. 164 H. 65÷85	W. 55"÷70 ¾" D. 64 ½" H. 25 ½"÷33 ½"
	Scrivanía bench Desk bench Bureau bench Schreibtisch bench Bureau bench Escritorio bench	L. 140÷180 P. 164 H. 65÷130	W. 55"÷70 ¾" D. 64 ½" H. 25 ½"÷51"
	Scrivanía bench Desk bench Bureau bench Schreibtisch bench Bureau bench Escritorio bench	L. 140÷180 P. 164 H. 65÷130	W. 55"÷70 ¾" D. 64 ½" H. 25 ½"÷51"
	Scrivanía bench Desk bench Bureau bench Schreibtisch bench Bureau bench Escritorio bench	L. 140÷180 P. 164 H. 65÷130	W. 55"÷70 ¾" D. 64 ½" H. 25 ½"÷51"
	Scrivanía bench Desk bench Bureau bench Schreibtisch bench Bureau bench Escritorio bench	L. 140÷180 P. 164 H. 65÷130	W. 55"÷70 ¾" D. 64 ½" H. 25 ½"÷51"
	Tavolino Small table Petit table Kleinertisch Kleine tafel Mesa	L. 70 P. 70 H. 40	L. 27 ½" D. 27 ½" H. 17 ¼"
	Tavolino Small table Petit table Kleinertisch Kleine tafel Mesa	L. 70÷80 P. 70÷80 H. 74	L. 27 ½"÷31 ½" D. 27 ½"÷31 ½" H. 29"



		cm	inch
	Tavolino Small table Petit table Kleinertisch Kleine tafel Mesa	L. 70 P. 70 H. 105	L. 27 ½" D. 27 ½" H. 41 ¼"
	Tavolo Table Table Tisch Tafel Mesa	L. 140÷160 P. 140÷160 H. 74	L. 55"÷63" D. 55"÷63" H. 29"
	Tavolo Table Table Tisch Tafel Mesa	L. 180 ÷ 240 P. 100 H. 74	L. 70 ¾"÷94½" D. 39 ¼" H. 29"
	Tavolo sagomato con colonna e base Shaped table with column and base Table façonnée avec colonne et base Tisch geformt mit Säule und Basis Gevormde tafel met kolom en basis Mesa per'lada con columna y base	L. 200 P. 104 H. 74	L. 78 ¾" D. 41" H. 29"
	Tavolo sagomato Shaped table Table façonnée Tisch geformt Gevormde tafel Mesa per'lada	L. 240 P. 120 H. 74	L. 94 ½" D. 47 ¼" H. 29"
	Tavolo Table Table Tisch Tafel Mesa	L. 204 ÷ 324 P. 124 L. 244 ÷ 364 P. 164 H. 74	W. 80 ¼" ÷ 127 ½" D. 48 ¾" W. 96" ÷ 143 ¼" D. 64 ½" H. 29"
	Tavolo Table Table Tisch Tafel Mesa	L. 360÷480 P. 100 H. 74	L. 141 ¾"÷189" D. 39 ¼" H. 29"

Alcuni esempi di possibili configurazioni - Some examples of possible layouts - Voici quelques exemples de configurations possibles - Einige Beispiele von möglichen Konfigurationen - Een aantal voorbeelden van mogelijke configuraties - Algunos ejemplos de configuraciones posibles

Per una più completa visione della collezione, consultare il listino
 Pour un meilleur aperçu de la collection, veuillez consulter la liste des prix
 Om de volledige collectie te raadplegen, zie de lijst

To view the collection in more detail, please refer to our price list
 Eine komplette Ansicht der Kollektion finden Sie in der Preisliste
 Para ver más detalladamente la colección, consultar la tarifa

winglet[™]
technical

		cm	inch
	Tavolo sagomato Shaped table Table façonnée Tisch geformt Gevormde tafel Mesa per'lada	L. 220 P. 120 H. 74	L. 86 3/4" D. 47 1/4" H. 29"
	Tavolo sagomato Shaped table Table façonnée Tisch geformt Gevormde tafel Mesa per'lada	L. 450 P. 450 H. 74	L. 177" D. 177" H. 29"
	Scrivania su ruote Desk Bureau Schreibtisch Bureau Escritorio	L. 120÷180 P. 80 H. 74	W. 47 1/4" ÷ 70 3/4" D. 31 1/2" H. 29"

Tipologie schermi - Types of screens - Types d'écrans - Schirm-Typen - Schermtypen - Tipos de pantallas

Per una più completa visione della collezione, consultare il listino
 Pour un meilleur aperçu de la collection, veuillez consulter la liste des prix
 Om de volledige collectie te raadplegen, zie de lijst

To view the collection in more detail, please refer to our price list
 Eine komplette Ansicht der Kollektion finden Sie in der Preisliste
 Para ver más detalladamente la colección, consultar la tarifa

Schermi divisori - Screens dividers - Écrans de séparation frontale - Trennschirme - Schermverdeling - Pantallas separadoras



Schermo frontale tessuto sp. 18 mm / 0¾"

Front fabric screen:
 18 mm / 0¾" thick
 Écran frontal en tissu
 ép. 18 mm / 0¾"
 Frontaler Schirm stoffbezogen
 Stärke 18 mm / 0¾"
 Scherm voorkant in stof dikte
 18 mm / 0¾"
 Pantalla frontal de tejido esp.
 18 mm / 0¾"



Schermo frontale alto melaminico sp. 18 mm, 0¾"

Front high laminate screen:
 18 mm / 0¾" thick
 Écran frontal haut mélaminé
 ép. 18 mm / 0¾"
 Frontaler hoher Schirm Melamin
 Stärke 18 mm / 0¾"
 Hoog scherm voorkant
 melamine dikte 18 mm / 0¾"
 Pantalla frontal alta melamina
 esp. 18 mm / 0¾"



Schermo divisorio in tessuto fonoassorbente sp 42 mm / 1¾" con profilo

Sound-absorbing fabric screen:
 42 mm / 1¾" thick with profile
 Écran de séparation frontale en tissu insonorisant
 ép. 42 mm / 1¾" avec profil
 Trennschirm aus schallschluckendem Stoff Stärke
 42 mm / 1¾" mit Profil
 Schermverdeling in akoestische stof dikte 42 mm
 / 1¾" met profiel
 Pantalla separadora de tejido fonoabsorbente
 esp. 42 mm / 1¾" con perfil

Schermi divisori laterali - Side screens dividers - Écrans de séparation latérale - Seitliche Trennschirme - Schermverdeling zijkant - Pantallas separadoras laterales



Schermo divisorio laterale laccato sp 18 mm / 0¾"

Lacquered side screen:
 18 mm / 0¾" thick
 Écran de séparation latérale laqué
 ép. 18 mm / 0¾"
 Seitlicher Trennschirm lackiert
 Stärke 18 mm / 0¾"
 Gelakte schermverdeling zijkant
 dikte 18 mm / 0¾"
 Pantalla separadora lateral lacada
 esp. 18 mm / 0¾"



Schermo riposizionabile in tessuto fonoassorbente sp 42 mm / 1¾"

Sound-absorbing mobile fabric side
 screen 42 mm / 1¾" thick
 Écran de séparation latérale en tissu
 ép. 42 mm / 1¾"
 Beliebig montierbarer Schirm aus
 schallschluckendem Stoff Tiefe 42 mm
 / 1¾"
 Stoffen schermverdeling zijkant
 dikte 42 mm / 1¾"
 Pantalla separadora lateral de tejido
 fonoabsorbente
 esp. 42 mm / 1¾"

Sistemi per il passaggio cavi e per l'elettificazione dei piani - Cable holding and top electrification systems - Systèmes passe-câbles et pour l'électrification des plateaux - Systeme für Kabeldurchlass und Elektrifizierung der Tischplatten - Kabeldoorvoersystemen en bekabelingssystemen van de bladen - Sistemas para el paso de los cables y para la electrificación de los sobres



uscita cavi sul piano tramite top access e tappi passacavi
top cable outlet through top access and cable holder port / sortie des câbles sur le plateau par top-access ou passe-câbles avec obturateur / Kabelaustritt auf der Tischplatte über Top Access und Kabel Dosen / kabeluitgang op het blad via top access en kabeldoorvoerdoppen / salida de los cables en el sobre mediante acceso superior y tapones pasacables



salita cavi attraverso passacavi attaccato alla gamba
cable holder fastened to the leg / remontée des câbles par le passe-câbles fixé au piètement / Kabelhochführung durch am Tischbein befestigte Kabeldurchführungen / mogelijkheid om kabels omhoog te voeren via kabeldoorvoer die vastgemaakt is aan de poot / salida de los cables a través de pasacables acoplado a la pata



con un semplice movimento, il piano arretra per consentire un facile accesso ai cavi
with a simple movement, the top moves backward for easy access to the cables / avec un simple mouvement, le plateau recule pour permettre un accès aisé aux câbles / mit einer einfachen Bewegung, die Tischplatte fährt zurück, um einen leichten Zugang zu den Kabeln zu ermöglichen / met een eenvoudige beweging wordt het blad teruggeschoven, waardoor de kabels op eenvoudige wijze toegankelijk zijn / con un simple movimiento, el sobre retrocede para facilitar el acceso de los cables

Per una più completa visione della collezione, consultare il listino
Pour un meilleur aperçu de la collection, veuillez consulter la liste des prix
Om de volledige collectie te raadplegen, zie de lijst

To view the collection in more detail, Please refer to our price list
Eine komplette Ansicht der Kollektion finden Sie in der Preisliste
Para ver más detalladamente la colección, consultar la tarifa



salita cavi tramite vertebra
vertebra cable holder / vertebre montée de câbles / Kabelhochführung durch Spirale / kabels via verticale geleider / ascenso de los cables mediante vértebra*

L'ampio alloggiamento nella vasca passacavi permette di mantenere ordinati e facilmente ispezionabili tutti i cavi e le connessioni

The wide cable holder tray housing allows you to keep all cables and connections neat and inspect them. / le grand logement dans le bac passe-câbles permet de maintenir les câbles et les branchements en ordre et facilement accessibles / Dank der großen Aufnahme in der Kabelrinne können alle Kabel und Anschlüsse in Ordnung gehalten und einfach kontrolliert werden / dankzij de ruime kabelgoot kunnen alle kabels en verbindingen ordelijk bewaard worden en kunnen ze eenvoudig geïnspecteerd worden / el amplio alojamiento de la bandeja pasacables permite mantener en orden todos los cables y las conexiones, facilitando su inspección

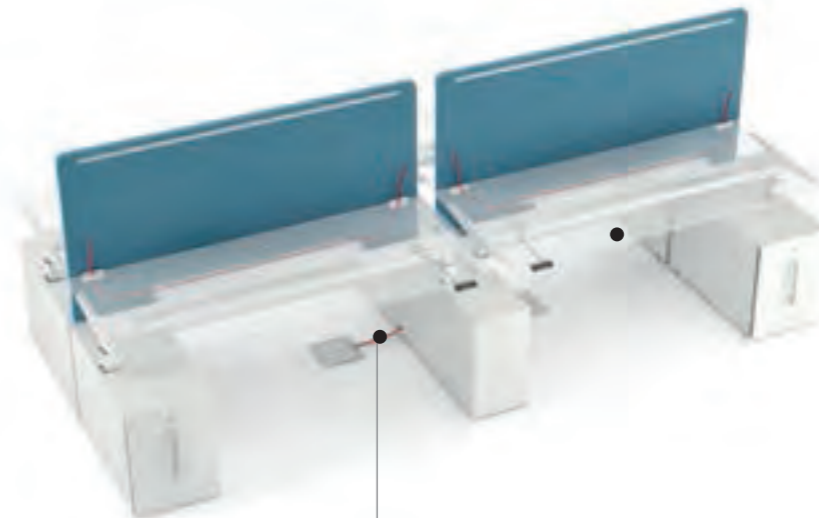

salita cavi attraverso il muretto centrale facilmente ispezionabili per il posizionamento dei cavi

cable holder through central wall easy to inspect when placing the cables / remontée des câbles par le piètement plein central facilement accessible pour le positionnement des câbles / Kabelhochführung über die Mittelwange, zwecks einfach zu kontrollierender Positionierung der Kabel / gemakkelijk inspecteerbare kabelopgang via de centrale wand voor het plaatsen van de kabels / salida de los cables a través del tabique central fácilmente inspeccionable para la colocación de los cables

Flipper, struttura e sistema di elettrificazione - Flipper, structure and electrification system
- Flipper, structure et système d'électrification - Flipper, Struktur und Elektrifizierungssystem -
Flipper, structuur en bekabelingssysteem - Flipper, estructura y sistema de electrificación

i cavi elettrici e i dati entrano dal basso o da appositi passaggi laterali e sono resi disponibili in diverse posizioni per alimentare il TV sul pannello frontale, oppure un tablet sulla mensola dedicata o ancora una web cam collocabile sulla parte superiore

Electric and data cables enter from the bottom or through special side holes, and are available in different positions to supply the TV on the front panel, or a tablet on the special shelf, or a webcam which can be placed on the upper section / Les câbles électriques et de données entrent par le bas ou par des passages latéraux spéciaux et ils sont mis à disposition dans des positions différentes pour alimenter le téléviseur sur le panneau avant, ou une tablette sur la console dédiée ou même une webcam pouvant être placée sur la partie supérieure / Elektrische Kabel oder Datenleitungen kommen von unten oder durch seitliche Öffnungen und sind in mehreren Positionen nutzbar zur Versorgung eines Fernsehers auf der Frontblende, eines Tablets auf der entsprechenden Konsole oder einer Webcam, die auf der oberen Seite positioniert werden kann / De voedings- en datakabels komen vanuit onderaf naar binnen of door de speciaal hiervoor bestemde openingen aan de zijkant en worden beschikbaar gemaakt in verschillende posities om de televisie op het voorpaneel te voeden, of een tablet op de hiervoor bestemde plank of een webcam die op het bovengedeelte geplaatst kan worden / Los cables eléctricos y de datos entran por abajo o por unos orificios laterales y resultan disponibles en distintas posiciones para alimentar la TV en el panel frontal, una tableta en el estante correspondiente o una cámara web colocada en la parte superior

il pannello svolge anche la funzione di lavagna scrivibile

The panel is also a whiteboard / Le panneau sert également de tableau blanc / Die Blende hat auch die Funktion einer beschriftbaren Tafel / Het paneel doet ook dienst als whiteboard / El panel desempeña también la función de pizarra escribible

i pannelli sono facilmente riposizionabili per un agevole posizionamento, controllo o manutenzione dei cavi all'interno

All panels can be easily detached to place, check or service the cables inside / Les panneaux peuvent être facilement repositionnés pour faciliter le positionnement, le contrôle ou l'entretien des câbles à l'intérieur / Die Blenden sind mühelos abnehmbar für eine einfache Inspektion und Wartung der Kabel im Inneren / De panelen kunnen makkelijk van positie worden verplaatst en worden herplaatst voor controle en onderhoud van de kabels of onderhoud van de interne kabels / Los paneles pueden desplazarse cómodamente para facilitar la colocación, el control o el mantenimiento de los cables presentes en el interior

ruote di ampie dimensioni per una agevole traslazione, dotate di blocco

Wide wheels with locking brake for higher ease of movement / Grandes roues pour un déplacement aisé, équipées de frein / Große Laufrollen für eine einfache Bewegung, ausgestattet mit Arretierung / Grote wielen voor een vlotte verplaatsing, met rem / Ruedas de amplias dimensiones para facilitar el desplazamiento, dotadas de bloqueo

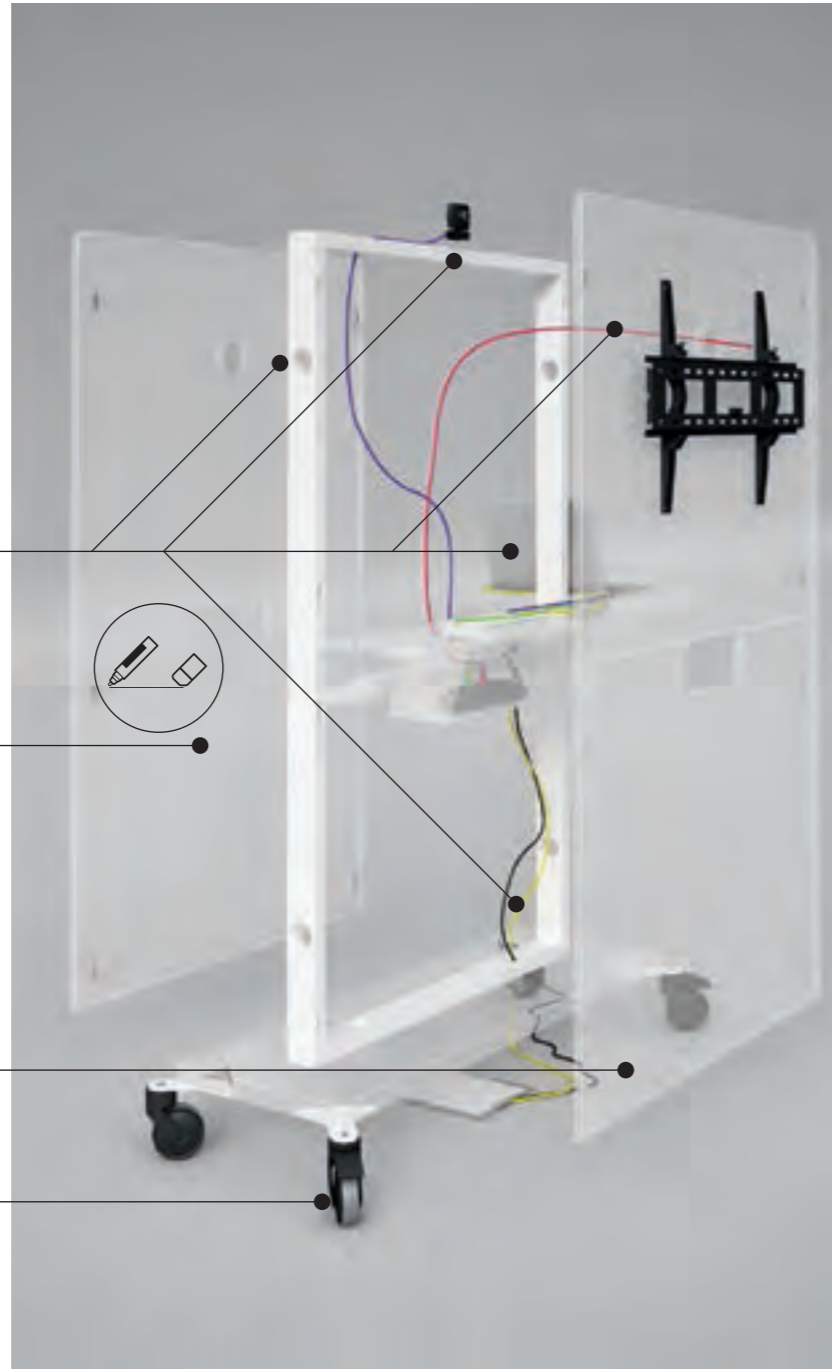

Per una più completa visione della collezione, consultare il listino
 Pour un meilleur aperçu de la collection, veuillez consulter la liste des prix
 Om de volledige collectie te raadplegen, zie de lijst

To view the collection in more detail, Please refer to our price list
 Eine komplette Ansicht der Kollektion finden Sie in der Preisliste
 Para ver más detalladamente la colección, consultar la tarifa

i cavi di alimentazione e dati possono entrare dagli appositi passaggi Flipper, alimentare i vari devices presenti ed essere resi disponibili anche per il piano meeting

Electric and data cables enter from the special holes on Flipper holes, to supply the different devices, and can be extended also to the meeting table / Les câbles d'alimentation et de données peuvent entrer par des passages spéciaux du Flipper, alimenter les divers appareils électriques présents et sortir éventuellement sur le plateau de la table de réunion / Elektrische Kabel und Datenleitungen für Geräte können durch die Flipper-Öffnungen eingeführt werden, und auch auf der Besprechungstischplatte verfügbar sein / De voedings- en gegevenskabels kunnen door de speciaal hiervoor bedoelde geleidingen van Flipper gestoken worden, de verschillende aanwezige toestellen voeden en ook beschikbaar zijn op het vergaderblad / Los cables de alimentación y de datos pueden entrar por los orificios correspondientes de Flipper, alimentar los distintos dispositivos y resultar también disponibles para el sobre de la mesa de reuniones



Flipper, nella versione a muro, è dotato di piedini di sostegno e regolazione

The wall version of Flipper is equipped with support and adjustment feet / Flipper, dans sa version murale, est équipé de pieds de support réglables / Flipper in der Wandausführung ist mit Stütz- und Justierfüßchen ausgestattet / De muurversie van Flipper beschikt over ondersteunende en afstelbare poten / En la versión de pared, Flipper está dotado de patas de soporte y regulación

Sistema Ubi - Ubi system - Système Ubi - Ubi System - System Ubi - Sistema Ubi

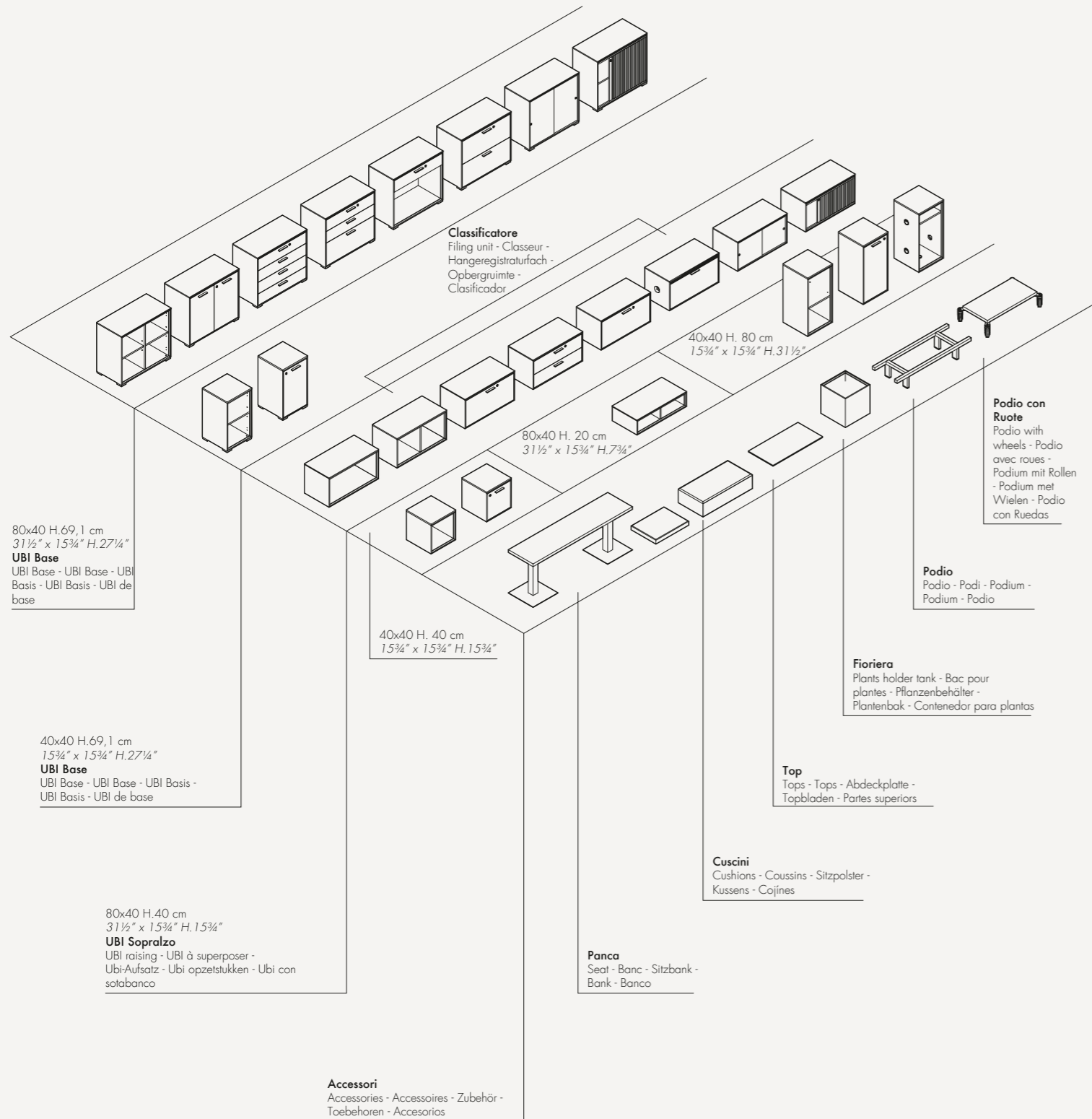

Cassettiere e mobili di servizio - Drawers and service cabinets - Caissons et meubles de service - Container und Sideboards - Ladekasten en service-unit - Cajoneras y muebles de servicio

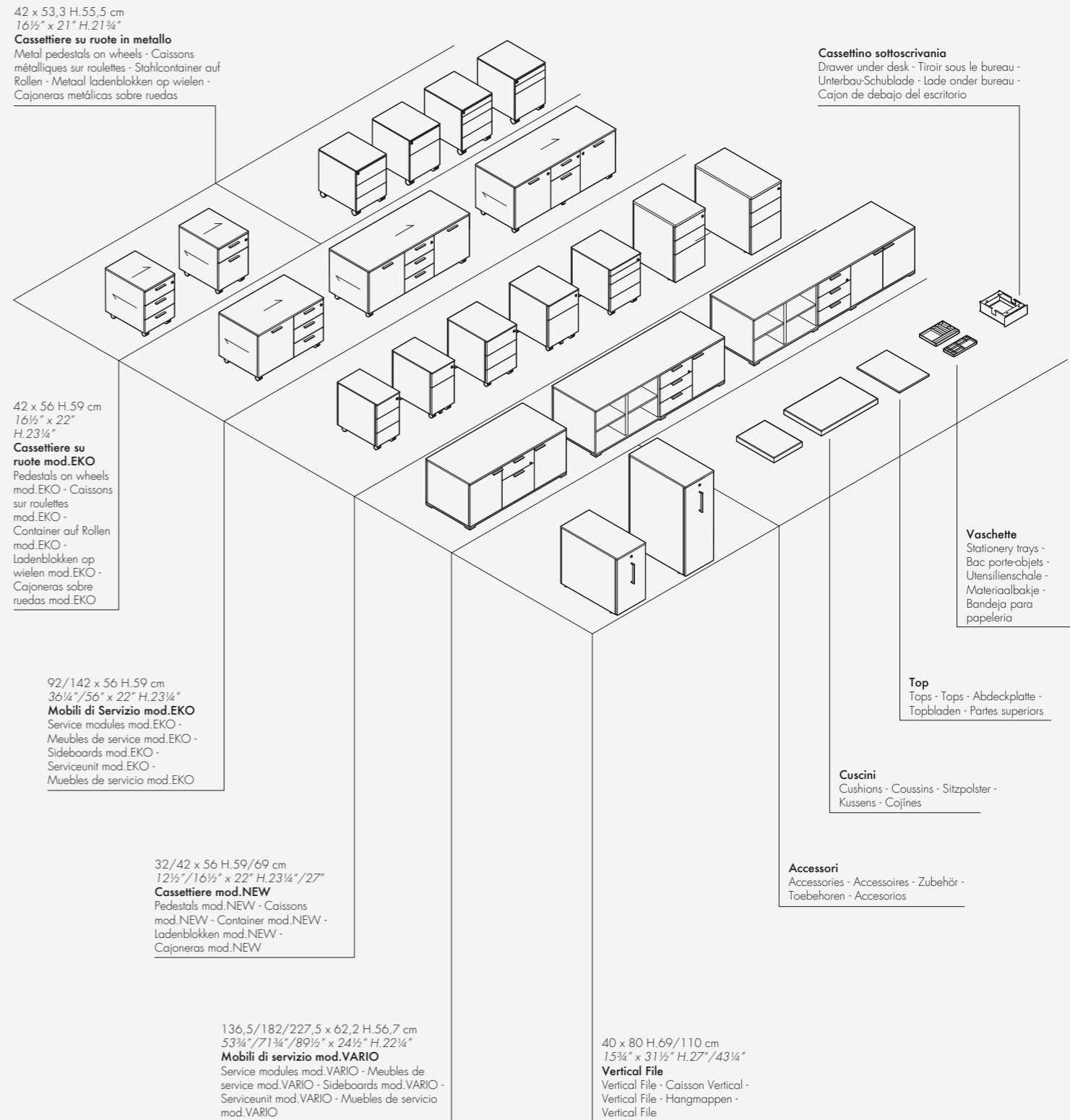

Armadi A100 p.36 cm / 14" - A100 closet system - d. 36 / 14" - Armoires A100 - p. 36/14" - Schranksystem A100 - Tiefe 36/14" - System Kasten A100 - d. 36/14" - Armarios A100 - p. 36 cm/14"

Armadi A100 p.46 cm / 18" - A100 closet system - d. 46 / 18" - Armoires A100 - p. 46/18" - Schranksystem A100 - Tiefe 46/18" - System Kasten A100 - d. 46/18" - Armarios A100 - p. 46 cm/18"

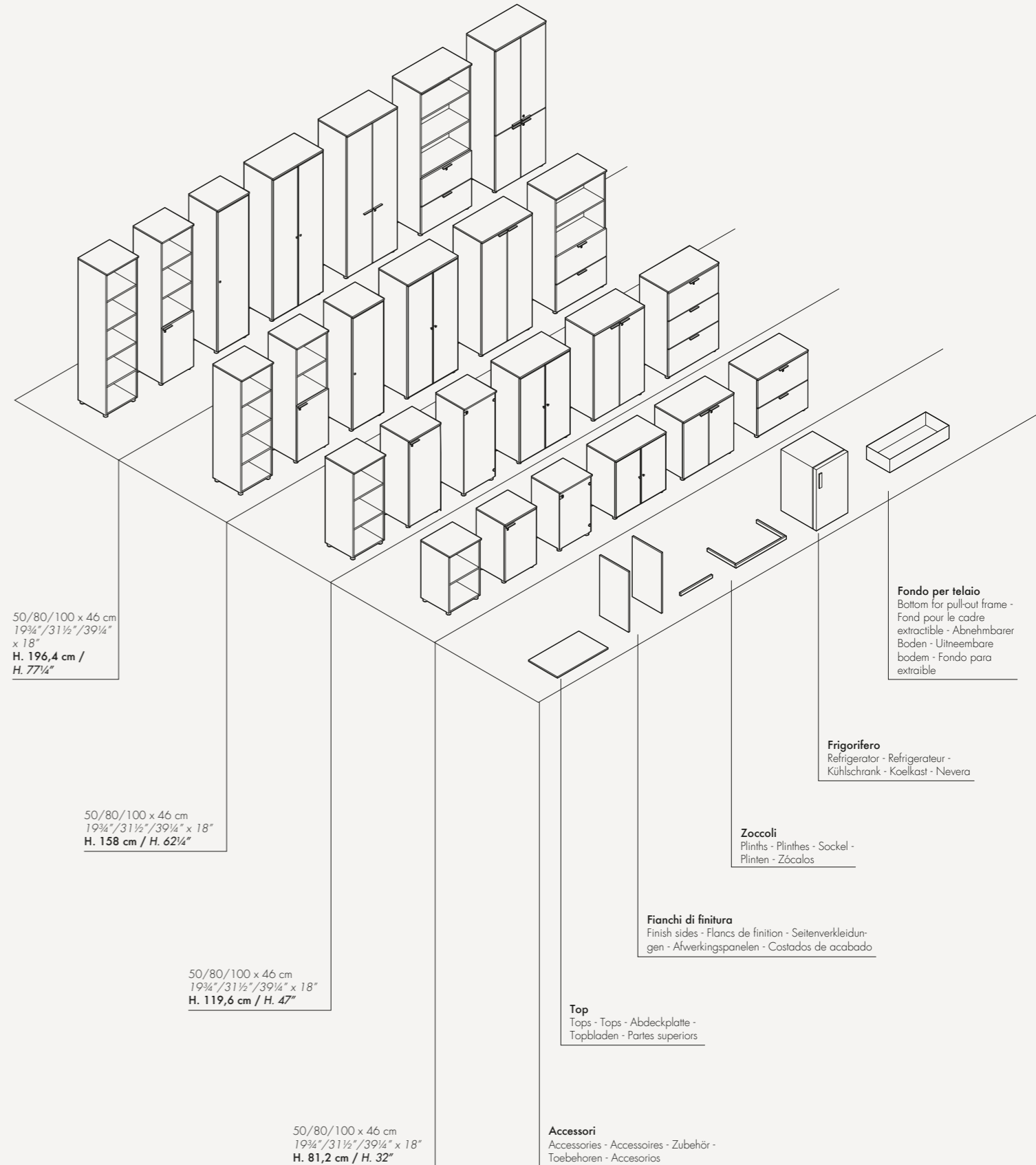
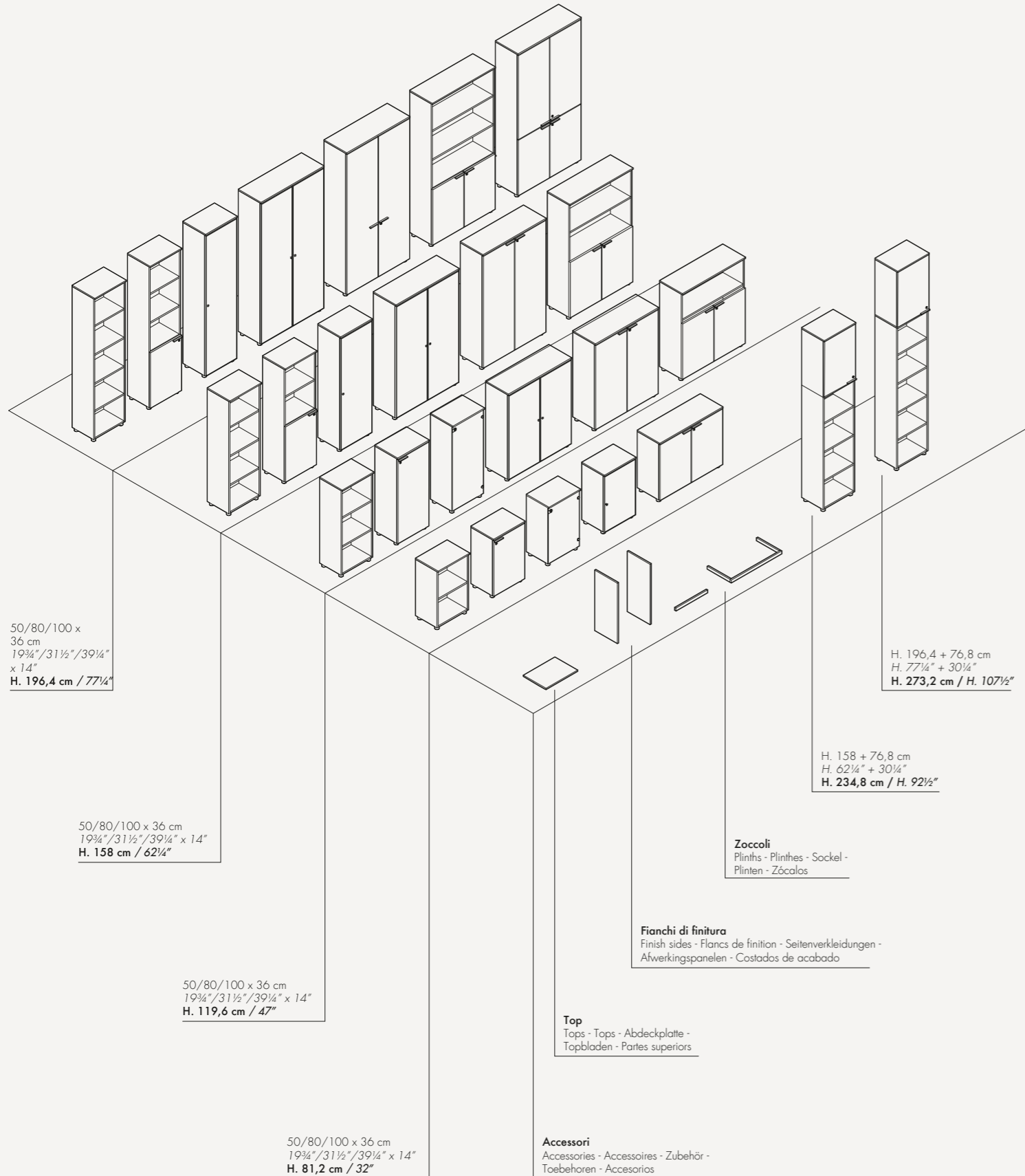

Accessori - Accessories - Accessoires - Zubehör - Accessoires - Accesorios

Per una più completa visione della collezione, consultare il listino
 Pour un meilleur aperçu de la collection, veuillez consulter la liste des prix
 Om de volledige collectie te raadplegen, zie de lijst

To view the collection in more detail, Please refer to our price list
 Eine komplette Ansicht der Kollektion finden Sie in der Preisliste
 Para ver más detalladamente la colección, consultar la tarifa

Tappo passacavi - Cable access port - Passe-câbles - Kabeldose - Kabeldoorvoerdop - Tapón pasacables



GZ.0008.B0



GZ.0008.A0

Cestelli portacavi - Cable holder baskets - Bac passe-cables - Kabelkörbe - Korfjes voor elektrische bedrading - Cestos portacables



GZ.0043.P1 - GZ.0046.P1



GZ.0067.P1



GZ.0068.P1

Top access - Top access - Top-access - Top access - Toegang bovenaan - Acceso superior



GZ.0058.A2



GZ.0024./A3 + GZ.0012.EU/.FR/.UK



GZ.0062.A3

Passacavi - Cable holder - Passe-câbles - Kabeldurchführungen - Kabeldoorvoer - Pasacables



GZ.0072.00



BZ.0072.00



GZ.0070.01



GZ.0059.01 / ZZ.0003.01

Portaprese - Socket-holder - Porte-prises - Elektro-Dosenblock - Stekker - Portatomas de corriente



GZ.0057.AE/.AF/.AU



GZ.0066.A1



GZ.0047.EU/.FR/.UK



GZ.0019.A0/.AF

Braccio portamonitor - Monitor stand - Porte-écran - Monitorträger - Monitorsteun - Brazo para monitor



GZ.0081.M1



GZ.0060.01 GZ.0060.02

Accessori - Accessories - Accessoires - Zubehör - Accessoires - Accesorios

Per una più completa visione della collezione, consultare il listino
Pour un meilleur aperçu de la collection, veuillez consulter la liste des prix
Om de volledige collectie te raadplegen, zie de lijst

To view the collection in more detail, Please refer to our price list
Eine komplette Ansicht der Kollektion finden Sie in der Preisliste
Para ver más detalladamente la colección, consultar la tarifa

Porta cpu - CPU holder - Support pour unité centrale - CPU Halter - CPU-houder - Soporte para CPU



WZ.0009.G1

Cassettino sottocrivania - Under-desk drawer - Tiroir sous le bureau - Unterbau-Schublade - Lade onder bureau - Cajón de debajo del escritorio



TZ.0304.00

Staffe di giunzione / aggregazione piani - Joining brackets / Top coupling - Étriers de jonction / assemblage plateaux - Plattenverbindungs-/anschlusssträger - Bevestigingsbeugels / haken voor bladen - Estribos de unión / agregación sobres



Sistemi di regolazione - Adjustment systems - Systèmes de réglage - Einstellsysteme - Instellingssystemen - Sistemas de regulación



Pulsante
Push button - Bouton-pous-
soir - Schalter - Drukknop
- Pulsador



Manovella
Crank - Manivelle - Kurbel -
Slinger - Manivela



Tastierino Up&Down
Up&Down keypad - Bouton
Up&Down - Druckknopf Up&
Down - Up&Down bediening
- Teclado Up&Down



Tastierino con 4 memorie e display
Keypad with 4 memories and display - Clavier avec 4 mém-
oires et afficheur lcd - Eingabefeld mit 4X Memory + Display
- Bediening met display en 4 geheugenstanden - Teclado
con 4 memorías y display

Compositions elements & dimensions

Per una più completa visione della collezione, consultare il listino
Pour une vue plus complète de la collection, voir la liste des prix
Voor een compleet overzicht van de collectie, zie de prijslijst
precios

For a more complete view of the collection, see the price list
Für eine vollständigere Ansicht der Sammlung finden Sie in der Preisliste
Para una visión más completa de la colección, consulte la lista de

22/23 24/25 26/27

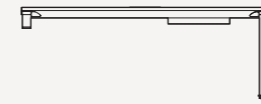

200 x 80 H.74 cm 78¾" x 31½" H.29"
Scrivania
Desk - Bureau - Schreibtisch - Bureau - Escritorio



141,8 x 56,3 H.57 cm 55¾" x 22" H.22½"
Mobile di servizio mod. Eko
Service Cabinet EKO - Meuble de service - Sideboard EKO - Serviceunit EKO -
Mueble de servicio EKO



364 x 164 H.74 cm 143¼" x 64½" H.29"
Tavolo riunione
Meeting table - Table de réunion - Konferenztisch - Vergadertafel -
Mesa de reunión



60 x 60 H.40 cm 23¾" x 23¾" H.15¾"
Tavolino
Small table - Petit table - Kaffeetisch Kleine tafel - Mesa

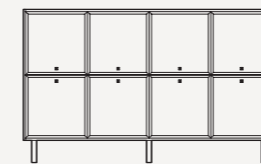

203,6 x 46 H.123 cm 80" x 18" H.48½"
Credenza 4+4 ante
Cabinet 4+4 doors - Armoire basse 4+4 portes - Anrichte 4+4 Türen
Kast 4+4 deuren - Aparador 4+4 puertas

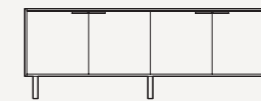

203,6 x 46 H.71,8 cm 80" x 18" H.28¼"
Credenza 2+2 ante
Cabinet 2+2 doors - Armoire basse 2+2 portes - Anrichte 2+2 Türen
Kast 2+2 deuren - Aparador 2+2 puertas

28/29 30/31



180 x 90 H.74 cm 70¾" x 35½" H.29"
Scrivania
Desk - Bureau - Schreibtisch - Bureau - Escritorio



120 x 60 H.74 cm 47¼" x 23¾" H.29"
Dattilo appeso
Workwall - Dactylo suspendu - Andocktisch - Oplegtafel - Ala escritorio suspendida



41,8 x 56,3 H.58,7 cm 16½" x 22" H.23"
Cassettiera 2 cassetti
Pedestal 2 drawers - Caisson 2 tiroirs - 2 Schubladen Container -
Ladenblok 2 laden - Cajonera 2 cajones



200 x 104 H.74 cm 78¾" x 41" H.29"
Tavolo riunione
Meeting table - Table de réunion - Konferenztisch - Vergadertafel - Mesa de reunión



303,6 x 46 H.159,8 cm 119½" x 18" H.63"
Armadio mod. A100
A100 Cabinet - Armoire A100 - Schränke A100 -
Kasten A100 - Armario A100



Ø140 H.74 cm Ø55" H.29"
Tavolo riunione
Meeting table - Table de réunion - Konferenztisch - Vergadertafel - Mesa de reunión

Compositions elements & dimensions

32/33 34/35



180 x 80 H.65÷85 cm 70¾" x 31½" H.25½"÷33½"
Scrivania
Desk - Bureau - Schreibtisch - Bureau - Escritorio



41,8 x 56,3 H.58,7 cm 16½" x 22" H.23"
Cassettiera 2 cassetti
Pedestal 2 drawers - Caisson 2 tiroirs - 2 Schubladen Container -
Ladenblok 2 laden - Cajonera 2 cajones

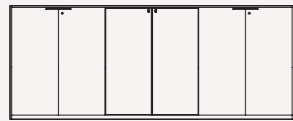

303,6 x 46 H.121,4 cm 119½" x 18" H.47¾"
Armadio mod. A100
A100 Cabinet - Armoire A100 - Schränke A100 -
Kasten A100 - Armario A100

36/37 38/39

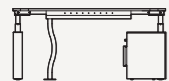

180 x 160 H.65÷130 cm 78¾" x 63" H.25½"÷51"
Scrivania con mobile
Desktop with cabinet - Bureau avec meuble - Schreibtisch mit Sideboard -
Schrifttafel met meubel - Escritorio con mueble

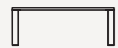

120 x 60 H.40 cm 47¼" x 23¾" H.15¾"
Tavolino
Small table - Petit table - Kaffeetisch
Kleine tafel - Mesa

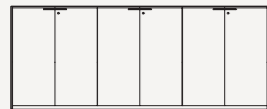

303,6 x 46 H.121,4 cm 119½" x 18" H.47¾"
Armadio mod. A100
A100 Cabinet - Armoire A100 - Schränke A100 -
Kasten A100 - Armario A100



120 x 60 H.65÷85 cm 47¼" x 23¾" H.25½"÷33½"
Dattilo appeso
Workwall - Dactylo suspendu - Andocktisch -
Oplegtafel - Ala escritorio suspendida

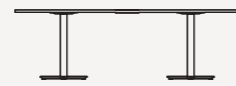

240 x 120 H.74 cm 94½" x 47¼" H.29"
Tavolo riunione
Meeting table - Table de réunion - Konferenztisch -
Vergadertafel - Mesa de reunión



240 x 100 H.65÷130 cm 94½" x 39¼" H.25½"÷51"
Tavolo riunione
Meeting table - Table de réunion - Konferenztisch -
Vergadertafel - Mesa de reunión



70 x 70 H.40 cm 27½" x 27½" H.15¾"
Tavolino
Small table - Petit table - Kaffeetisch
Kleine tafel - Mesa



503,6 x 46 H.83 cm 198¼" x 18" H.32¾"
Armadio mod. A100
A100 Cabinet - Armoire A100 - Schränke A100 -
Kasten A100 - Armario A100

42/43 44/45

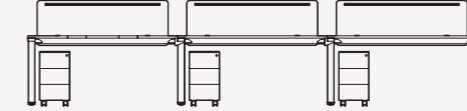

480 x 164 H.74 cm 189 x 64½" H.29"
Composizione Bench 6 p.
Bench composition 6 p. - Poste de travail 6 p. -
Bench-Arbeitsplatz 6 p. - Samen-
stelling bench 6 p. - Composición bench 6 p.

140 x 2,1 x H.48 cm 55" x 0¾" H.18¾"
Schermo divisorio
High screen - Écran haut - Hoher Sichtschutz -
Hoog scherm - Pantalla alta

31,8 x 56,3 H.58,7 cm 12½" x 22" H.23"
Cassettiera Slim 3 cassetti
Pedestal Slim 3 drawers - Caisson Slim 3 tiroirs -
3 Schubladen Slim Container - Ladenblok Slim 3 laden -
Cajonera Slim 3 cajones

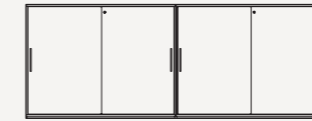

320 x 40 H.121,4 cm 126" x 15¾" H.47¾"
Armadio con ante scorrevoli
Cabinet with sliding doors - Armoire avec vantaux coulissants -
Schränke mit Schiebetüren - Kasten met schuifdeuren -
Armario con puertas correderas

46/47

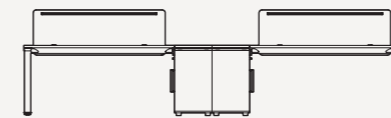

400 x 324 H.74 cm 157½" x 127½" H.29"
Composizione Bench
Bench composition - Poste de travail -
Bench-Arbeitsplatz - Samen-
stelling bench - Composición bench

140 x 2,1 x H.48 cm 55" x 0¾" H.18¾"
Schermo divisorio
High screen - Écran haut - Hoher Sichtschutz -
Hoog scherm - Pantalla alta



320 x 40 H.74 cm 126" x 15¾" H.29"
Armadio con ante scorrevoli
Cabinet with sliding doors - Armoire avec vantaux coulissants -
Schränke mit Schiebetüren - Kasten met schuifdeuren -
Armario con puertas correderas

For a more complete view of the collection, see the price list
Für eine vollständigere Ansicht der Sammlung finden Sie in der Preisliste
Para una visión más completa de la colección, consulte la lista de

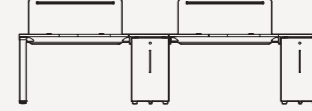

320 x 164 H.74 cm 126 x 64½" H.29"
Composizione Bench 4 p.
Bench composition 4 p. - Poste de travail 4 p. -
Bench-Arbeitsplatz 4 p. - Samen-
stelling bench 4 p. - Composición bench 4 p.

100 x 2,1 x H.48 cm 39¼" x 0¾" H.18¾"
Schermo divisorio
High screen - Écran haut - Hoher Sichtschutz -
Hoog scherm - Pantalla alta

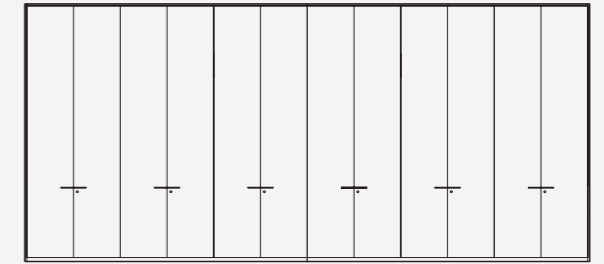

603,6 x 46 H.275 cm 237¾" x 18" H.108¼"
Armadio mod. A100
A100 Cabinet - Armoire A100 - Schränke A100 -
Kasten A100 - Armario A100

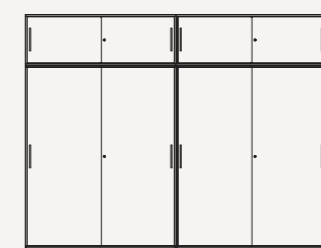

320 x 40 H.249,5 cm 126" x 15¾" H.98¼"
Armadio con ante scorrevoli
Cabinet with sliding doors - Armoire avec vantaux coulissants -
Schränke mit Schiebetüren - Kasten met schuifdeuren -
Armario con puertas correderas

Compositions elements & dimensions

48/49

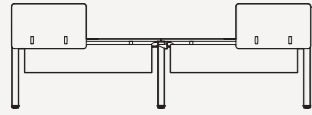

320 x 80 H.74 cm 126" x 31½" H.29"

N.02 Scrivanie
N.02 Desks - N.02 Bureaux - N.02 Schreibtische -
N.02 Bureaus - N.02 Escritorios

80 x 1,8 H.48 cm 31½" x 0¾" H.18¾"

Schermo
Screen - Écran - Sichtschutz - scherm - Pantalla

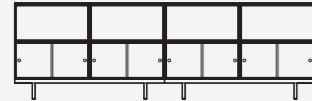

320,6 x 40 H.103 cm 126¼" x 15¾" H.40½"

Contentori mod. UBI EVO
UBI EVO Containers - Cubes UBI EVO - Container UBI EVO - Containers UBI
EVO - Contenedores UBI EVO



80 x 60 H.74 cm 31½" x 23¾" H.29"

Dattilo appeso
Warkwall - Dactylo suspendu - Andocktisch -
Oplegtafel - Ala escritorio suspendida



Ø60 H.40 cm Ø23¾" H.15¾"

Tavolino
Small table - Petit table - Kaffeetisch
Kleine tafel - Mesa

54/55

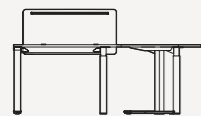

200,8 x 230,3 H.74 cm 78¾" x 90½" H.29"

N.02 Scrivanie
N.02 Desks - N.02 Bureaux - N.02 Schreibtische -
N.02 Bureaus - N.02 Escritorios

100 x 1,8 H.48 cm 39¾" x 0¾" H.18¾"

Schermo divisorio
High screen - Écran haut - Hoher Sichtschutz - Hoog scherm - Pantalla alta



142 x 56 H.57 cm 56" x 22" H.22½"

Mobile di servizio mod. Eko
Service Cabinet EKO - Meuble de service - Sideboard EKO -
Serviceunit EKO - Mueble de servicio EKO



320 x 40 H.74 cm 126" x 15¾" H.29"

Armadio
Cabinet - Armoire - Schränke - Kasten - Armario

56/57 58/59

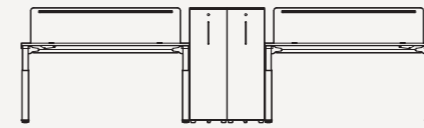

180 x 164 H.112,3 cm 70¾" x 64½" H.44¼"

Composizione Bench
Bench composition - Poste de travail - Bench-Arbeitsplatz - Samen-
stelling bench - Composición bench

40 x 80 H.112,2 cm 15¾" x 31½" H.44"

Vertical file (2dx+2sx)
Vertical file 2Rh+2Lh - Classeur vertical 2Dr+2Ga - Vertical File 2Re+2Li - Opbergunit
2Re+2Li - Archivador vertical 2De+2Li

179,5 x 4 H.58 cm 70¾" x 1½" H.22¾"

Schermo divisorio
High screen - Écran haut - Hoher Sichtschutz - Hoog scherm - Pantalla alta



31,8 x 56,3 H.58,7 cm 12½" x 22" H.23"

Cassettiera Slim 3 cassetti
Pedestal Slim 3 drawers - Caisson Slim 3 tiroirs - 3 Schubladen Slim Container -
Ladenblok Slim 3 laden - Cajonera Slim 3 cajones

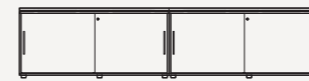

320 x 40 H.74 cm 126" x 15¾" H.29"

Armadio con ante scorrevoli
Cabinet with sliding doors - Armoire avec vantaux coulissants - Schränke mit
Schiebetüren - Kasten met schuifdeuren - Armario con puertas correderas

60/61

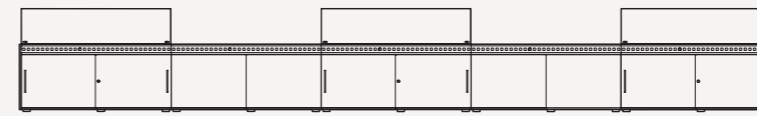

805,6 x 60 H.72 cm 317" x 23¾" H.28¼"

M10

160 x 2,1 H.37,5 cm 63" x 0¾" H.14¾"

Schermo divisorio
High screen - Écran haut - Hoher Sichtschutz - Hoog scherm - Pantalla alta

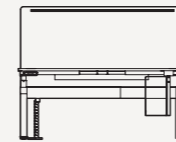

180 x 164 H.65÷130 cm 70¾" x 64½" H.25½"÷51"

Composizione Bench
Bench composition - Poste de travail - Bench-Arbeitsplatz - Samen-
stelling bench - Composición bench

175 x 4 H.86 cm 68¾" x 1½" H.33¾"

Schermo divisorio
High screen - Écran haut - Hoher Sichtschutz - Hoog scherm - Pantalla alta

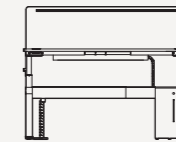

180 x 164 H.65÷130 cm 70¾" x 64½" H.25½"÷51"

Composizione Bench
Bench composition - Poste de travail - Bench-Arbeitsplatz - Samen-
stelling bench - Composición bench

For a more complete view of the collection, see the price list
Für eine vollständigere Ansicht der Sammlung finden Sie in der Preisliste
Para una visión más completa de la colección, consulte la lista de

Compositions elements & dimensions

62/63

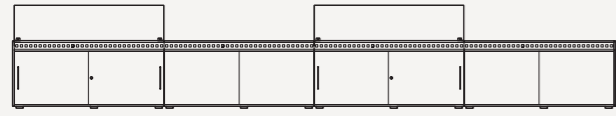

645,2 x 60 H.72 cm 254" x 23¾" H.28¼"

M10

160 x 2,1 H.37,5 cm

Schermo divisorio

High screen - Écran haut - Hoher Sichtschutz - Hoog scherm - Pantalla alta

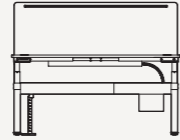

180 x 164 H.65±130 cm 70¾" x 64½" H.25½"±51"

Composizione Bench

Bench composition - Poste de travail - Bench-Arbeitsplatz - Samenstelling bench - Composición bench

175 x 4 H.86 cm

68¾" x 1½" H.33¾"

Schermo divisorio

High screen - Écran haut - Hoher Sichtschutz - Hoog scherm - Pantalla alta

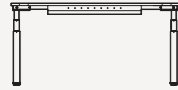

180 x 80 H.65±130 cm 70¾" x 31½" H.25½"±51"

Scrivania

Desk - Bureau - Schreibtisch - Bureau - Escritorio

64/65

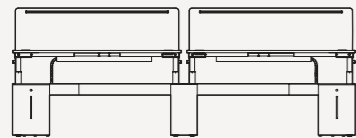

366 x 164 H.65±130 cm 144" x 64½" H.25½"±51"

Composizione Bench

Bench composition - Poste de travail - Bench-Arbeitsplatz - Samenstelling bench - Composición bench

155 x 4 H.86

61" x 1½" H.33¾"

Schermo divisorio

High screen - Écran haut - Hoher Sichtschutz - Hoog scherm - Pantalla alta

68/69



450 x 450 H.74 cm 177" x 177" H.29"

Tavolo riunione

Meeting table - Table de réunion - Konferenztisch - Vergadertafel - Mesa de reunión

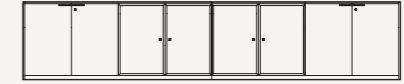

403,6 x 46 H.83 cm 158¾" x 18" H.32¾"

Armadio mod. A100

A100 Cabinet - Armoire A100 - Schränke A100 - Kasten A100 - Armario A100

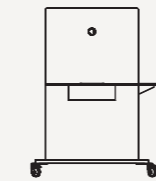

144 x 55 H.180 cm 56¾" x 21¾" H.70¾"

FLIPPER su ruote con mensola

Flipper on castors with shelf - Flipper sur roulettes avec étagère - Flipper auf Rollen mit Konsole - Flipper op wielen met plank - Flipper sobre ruedas con estante

70/71



400 x 100 H.74 cm 157½" x 39¼" H.29"

Tavolo riunione

Meeting table - Table de réunion - Konferenztisch - Vergadertafel - Mesa de reunión

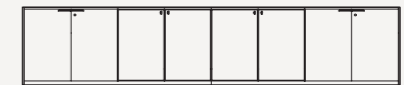

403,6 x 46 H.83 cm 158¾" x 18" H.32¾"

Armadio mod. A100

A100 Cabinet - Armoire A100 - Schränke A100 - Kasten A100 - Armario A100

72/73



160 x 80 H.74 cm 63" x 31½" H.29"

Scrivania su ruote

Desk on castors - Bureau sur roulettes - Schreibtische auf Rollen - Bureau op wielen - Escritorio sobre ruedas

74/75

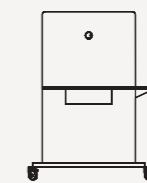

144 x 55 H.180 cm 56¾" x 21¾" H.70¾"

FLIPPER su ruote con mensola

Flipper on castors with shelf - Flipper sur roulettes avec étagère - Flipper auf Rollen mit Konsole - Flipper op wielen met plank - Flipper sobre ruedas con estante

Compositions elements & dimensions

 78/79

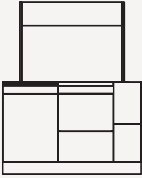

135 x 83,5 H.170 cm 53" x 32¾" H.67"

Composizione Domomag

Domomag arrangement - Composition Domomag - Domomag-Kombination - Combinatie Domomag - Composición Domomag

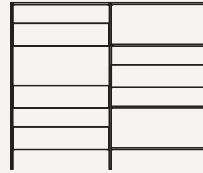

202 x 36 x 170 cm 79 ½" x 14" x H.67"

Scaffale

Shelf - Rayonnage - Regal - Boekenrek - Estantería



80 x 80 H.74 cm 31½" x 31½" H.29"

Tavolino

Small table - Petit table - Kaffeetisch
Kleine tafel - Mesa



70 x 70 H.105 cm 27½" x 27½" H.41¼"

Tavolino

Small table - Petit table - Kaffeetisch
Kleine tafel - Mesa

 80/81

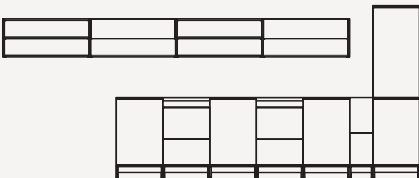

351 x 54 H.198 cm 138" x 21¼" H.78"

Composizione Domomag

Domomag arrangement - Composition Domomag - Domomag-Kombination - Combinatie Domomag - Composición Domomag



240 x 100 H.65÷130 cm 94½" x 39¼" H.25½"÷51"

Tavolo

Table - Table - Tisch
Tafel - Mesa

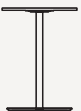

70 x 70 H.105 cm 27½" x 27½" H.41¼"

Tavolino

Small table - Petit table - Kaffeetisch
Kleine tafel - Mesa



Ø80 H.73÷109 cm Ø31½" H.28¾"÷43"

Tavolino

Small table - Petit table - Kaffeetisch
Kleine tafel - Mesa

Finiture - Finishes - Finitions - Oberflächen - Afwerkingen - Acabados

Melaminico - Coated panel - Mèlamine - Melamin - Melamine - Melamina

BL	MK	RN	NC	WE	WW
Bianco White Blanc Weiß Wit Blanco	Nero Black Noir Schwarz Zwart Negro	Rovere Naturale Natural Oak Chêne Naturel Natur Eiche Eikenhout Natuur Roble Natural	Noce Canaletto Canaletto Walnut Noyer Canaletto Canaletto Nussbaum Notenhout Canaletto Nagal Canaletto	Wengé Wengé Wengé Wengé Wengé Wengé	wengé scuro dark wengé wengé foncé dunkel Wengé Donker wengé wengé oscuro

Laccato opaco - Matt lacquered - Lacqué mat - Matt lackiert - Matgelakt - Lacado mate

LB	L3	L4	L5	LE	LF
Bianco White Blanc Weiß Wit Blanco	Nebbia Mist Brouillard Nebelgrau Mist Niebla	Titanio Titanium Titane Titan Titanium Titanio	Oceano Ocean Océan Meerblau Ocean Oceano	Deep Teal Deep Teal Bleu Canard Deep Teal Deep Teal Deep Teal	Verde Natura Gras Green Vert Nature Grasgrün Groene Natuur Verde Naturaleza
L6	LJ	LN	LA	LR	
Verde Muschio Moss Green Vert Mousse Moosgrün Mosgroen Verde Musgo	Giallo Gold Yellow Gold Jaune Or Goldgelb Geelgouden Oro Amarillo	Nero Black Noir Schwarz Zwart Negro	Alluminio Aluminium Aluminium Aluminium Aluminium Aluminio	Bordeaux Bordeaux Bordeaux Bordeaux Bordeaux Bordeaux	

Strutture metalliche - Metal structures - Structures métalliques - Metallstrukturen - Metalen structuren - Estructura metálicas

AF	BW	KR
Epoxy Alluminio Silver Epoxy Epoxy Aluminium Aluminium Aluminiumkleur Geepoxeerd Epoxidica De Aluminio	Bianco White Blanc Weiß Wit Blanco	Cromo Lucido Glossy Chrome Chromé Brillant Chrom Poliert Glanzend Verchroomd Cromo Pulido

Finiture - Finishes - Finitions - Oberflächen - Afwerkingen - Acabados

Tessuto - Fabric - Tissu - Stoff - Stof - Tejido

Puma A + B	PV	P4	P8	P2	PG	P1
	Verde Mela Apple Green Vert Pomme Apfelgrün Appelgroen Verde Manzana	Bordeaux Bordeaux Bordeaux Bordeaux Bordeaux Bordeaux	Blu Dark Blue Bleu Blau Blauw Azul	Grigio Medio Medium Grey Gris Moyen Mittelgrau Gewoon Grijs Gris Hormigón	Grigio Scuro Dark Grey Gris Foncé Dunkelgrau Donkergrijs Gris Oscuro	Nero Black Noir Schwarz Zwart Negro
	P5					
	Bianco White Blanc Weiß Wit Blanco					
Lucia A + B	A1	A2	A3	A4	A5	A6
	Sabbia - Aruba Sable - Aruba Sable - Aruba Sandfarbe - Aruba Zand - Aruba Arena - Aruba	Matrone - Jamaica Brick-Coloured - Jamaica Brique - Jamaica Ziegelrot - Jamaica Baksteen - Jamaica Pardo Cobre - Jamaica	Celeste - Arecibo Light Blue - Arecibo Bleu - Arecibo Hellblau - Arecibo Hemelsblauw - Arecibo Azul Celeste - Arecibo	Blu - Martinique Bleu - Martinique Bleu - Martinique Blau - Martinique Blauw - Martinique Azul - Martinique	Petrolio - Windjammer Petroleum - Windjammer Pétrole - Windjammer Petroleum Blau - Windjammer Petroleum - Windjammer Petróleo - Windjammer	Testa Di Moro - Sombrero Dark Brown - Sombrero Brun Gris - Sombrero Dunkelbraun - Sombrero Pardo Grisáceo - Sombrero
Stay B	Y1	Y2	Y3	Y4	Y5	Y6
	Giallo Yellow Jaune Gelb Geel Amarillo	Arancio Orange Orange Orange Oranje Naranja	Verde Green Vert Grün Groen Verde	Celeste Light Blue Bleu Hellblau Hemelsblauw Azul Celeste	Blu Avio Air Force Blue Bleu Aviation Avio Blau Avio-Blauw Azul Colombino	Grigio Londra London Grey Gris Landres London Grau Londen-Grijs Gris Londres
Xpress B	X1	X2	X3			
	Giallo Primavera Spring Yellow Jaune Printemps Frühling Gelb lentegeel Amarillo Primavera	Verde Sottobosco Underwood Green Vert Sous-Bois Unterholz Grün Bosgrond-Groen Verdes Sotobosque	Blue Jeans Blue Jeans Denim Blue Blue Jeans Blau Jeansblauw Azul Denim			

A	B
Per sedute For armchair Pour les chaises Für Stühle Voor stoelen Para las sillas	Per schermi For screens Pour écrans Für Schirmwände Voor schermen Para las pantallas

gate

*melaminico bianco e tinta
alluminio, alluminio*

*white and on color aluminium
mélamine, aluminium*

*mélaminé blanc et sur teinte
aluminium, aluminium*

*Melamin Weiß und
Aluminium Farbe, Aluminium*

*melamine op kleur wit en
aluminium, aluminium*

*melamina blanco y con color
aluminio, aluminio*

office workplace



*melaminico rovere naturale e bianco,
aluminio*

*natural oak and white melamine,
aluminium*

*mélatiné chêne naturel et blanc,
aluminium*

*Melamin natur Eiche und Weiß,
Aluminium*

*melamine eikenhout natuur en
wit, aluminium*

*melamina roble natural y
blanco, aluminio*



*melaminico wengé e bianco, bianco,
laccato tortora*

*wengé and white mélamine, white,
turtledove lacquered*

*mélaminé wengé et blanc, blanc,
laqué tourterelle*

*Melamin Wengé und Weiß, Weiß,
taubengrau lackiert*

*melamine op kleur wengé en
wit, wit, gelakt tortelduif*

*melamina wengé y blanco,
blanco, laqueado tórtola*



gate

composition elements & dimensions

05

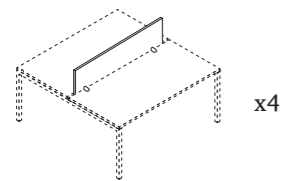
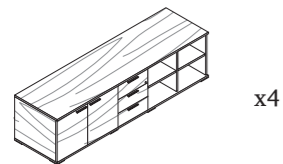
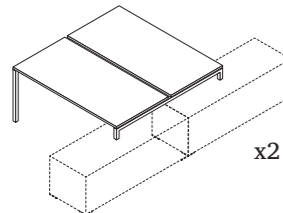
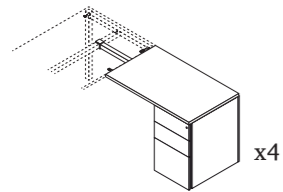
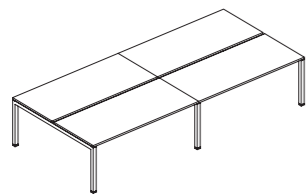

06/07

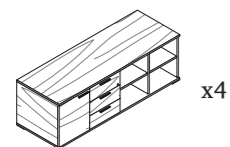
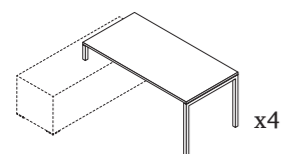

composizione bench per 4 persone
bench composition for 4 people
poste de travail pour 4 personnes
Arbeitsplatz für 4 personen
samestelling bench voor 4 plaatsen
composicion bench para 4 personas

dattilo con cassetiera portante
hanging additional desk with support
pedestal dactylo avec caisson portant
Hangender tischmodul mit Schubladenkasten
opleghulptafel met ladenblok
ala colgante con cajonera de sustentacion

scrivania a ponte · bridge desk · bureau
en pont · schreibtisch Brückenkonstruktion
brugbureau · escritorio en puente

mobile di servizio · service module
meuble de service · Service-Mobel
dienstmodule · mueble de servicio

schermo · screen · écran
Bildschirm · scherm · pantalla

scrivania a ponte · bridge desk · bureau
en pont · schreibtisch Brückenkonstruktion
brugbureau · escritorio en puente

mobile di servizio · service module
meuble de service · Service-Mobel
dienstmodule · mueble de servicio

L x P x H

320 x 164 x 72 cm

120 x 60 x 72 cm

160 x 164 x 72 cm

227,5 x 62,2 x 56,7 cm

140 x 1,8 x 40 cm

L x P x H

160 x 80 x 72 cm

182 x 62,2 x 56,7 cm

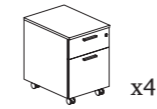

x4

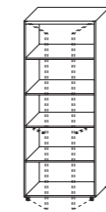

x2

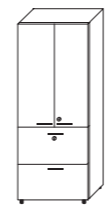

x4

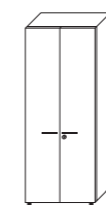

x2

08/09

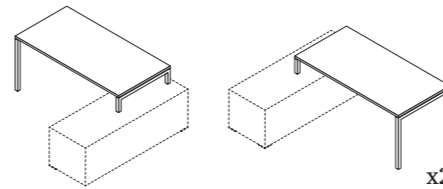

x2

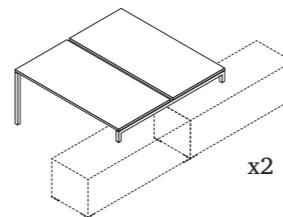

x2

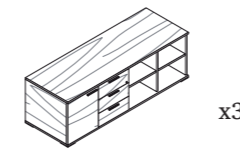

x3

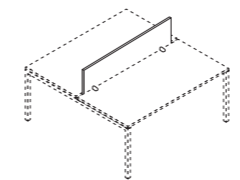

x2

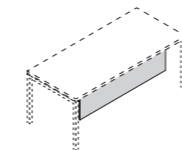

cassetiera · pedestals · caissons
container · ladenblok · cajonera

armadio · cabinet · armoire
Schränk · kast · armario

armadio · cabinet · armoire
Schränk · kast · armario

42 x 56 x 59 cm

80 x 44 x 196,4 cm

80 x 46 x 196,4 cm

L x P x H

scrivania a ponte · bridge desk · bureau
en pont · schreibtisch Brückenkonstruktion
brugbureau · escritorio en puente

160 x 80 x 72 cm

scrivania a ponte · bridge desk · bureau
en pont · schreibtisch Brückenkonstruktion
brugbureau · escritorio en puente

180 x 164 x 72 cm

mobile di servizio · service module
meuble de service · Service-Mobel
dienstmodule · mueble de servicio

182 x 62,2 x 56,7 cm

schermo · screen · écran
Bildschirm · scherm · pantalla

140 x 1,8 x 40 cm

modesty panel · modesty panel
voile de fond · Schreibtischblende
bureaubord · panel

136 x 1,8 x 31 cm

*melaminico bianco, rovere naturale
e nebbia, bianco.*

*natural oak, white and mist
melamine, white.*

*mélaminé chêne naturel, blanc
et brouillard, blanc.*

*Melamin natur Eiche, Weiß
und Nebelgrau, Weiß.*

*melamine eikenhout natuur,
wit en mist, wit.*

*melamina roble natural,
blanco y niebla, blanco.*



melaminico wengé e bianco, bianco_

wengé and white melamine, white_

mélaminé wengé et blanc, blanc_

Melamin Wengé und Weiß, Weiß_

melamine wengé en wit, wit_

melamina wengé y blanco, blanco_



Cambiano tempi e tecnologie, mutano i modi di lavorare. I nuovi sistemi bench con scrivanie lineari accostabili e allungabili con gambe arretrate interpretano la razionalità dell'ufficio.

Times and technology change, and so do the ways in which we work. The new bench systems interpret your office rationally through the use of recessed legs and linear extendible desks that can be joined together.

*melaminico bianco e tortora,
bianco, vetro temperato grigio.*

*white and turtledove
melamine, white, grey
tempered glass.*

*mélaminé blanc et tourterelle,
blanc, verre trempé gris.*

*Melamin Weiß und
taubengrau, Weiß, Grau
Temperiertes Glas.*

*melamine wit en tortelduif,
wit, gehard glas grijs.*

*melamina blanco y tórtola,
blanco, vidrio templado gris.*

Les temps et les technologies changent, les méthodes de travail se métamorphosent. Les nouveaux systèmes bench, dotés de bureaux linéaires, que l'on peut rapprocher et allonger, avec pieds en retrait, sont le symbole de la rationalité du bureau.

Die Zeiten und die Technologien ändern sich, und mit ihnen die Arbeitsweisen. Die neuen Bench-Systeme mit linear aneinanderzureihenden und verlängerbaren Schreibtischen mit zurückversetzten Beinen interpretieren die Rationalität des Büros.

De tijden en de technologieën wijzigen, de werkwijzen veranderen. De nieuwe "bench"-systemen met samenstelbare en verlengbare lineaire werktafels met achteruit geplaatste poten, interpreteren de rationaliteit van het kantoor.

Cambian los tiempos y las tecnologías, cambia la forma de trabajar. Los nuevos sistemas bench con escritorios lineales que se pueden arrimar y alargar con patas retrasadas, interpretan la racionalidad de la oficina.



gate

composition elements & dimensions

12/13

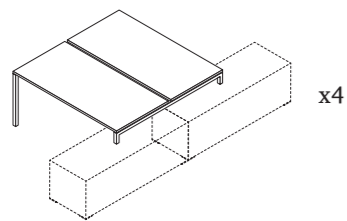

scrivania a ponte · bridge desk · bureau en pont · schreibtisch Brückenkonstruktion
brugbureau · escritorio en puente

L x P x H

180 x 164 x 72 cm

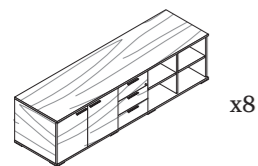

mobile di servizio · service module
meuble de service · Service-Mobel
dienstmodule · mueble de servicio

227,5 x 62,2 x 56,7 cm

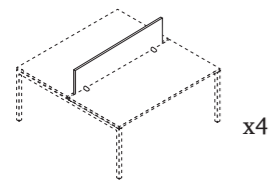

schermo · screen · écran
Bildschirm · scherm · pantalla

120 x 1,8 x 40 cm

14/15

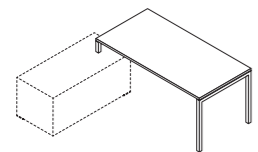

scrivania a ponte · bridge desk · bureau en pont · schreibtisch Brückenkonstruktion
brugbureau · escritorio en puente

L x P x H

180 x 80 x 72 cm

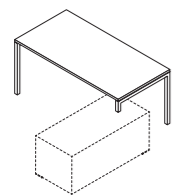

scrivania a ponte · bridge desk · bureau en pont · schreibtisch Brückenkonstruktion
brugbureau · escritorio en puente

180 x 80 x 72 cm

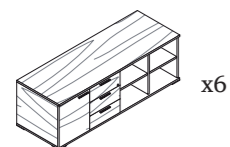

mobile di servizio · service module
meuble de service · Service-Mobel
dienstmodule · mueble de servicio

182 x 62,2 x 56,7 cm



piano scrivania · desk top
plateau de bureau · schreibtischplatte
bureaublad · plano de escritorio

180 x 80 x 3 cm

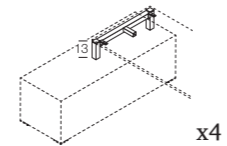

gamba zoppa · shortened leg
support bureau · verkurztes Bein
manke poot · pata coja

80 x 5 x 13 cm

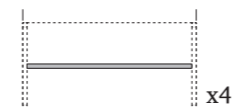

trave scrivania · desk beam
traverse bureau · trager Schreibtisch
dwarsbalk schrijftafel · viga del escritorio

170 x 4 x 4 cm

16/17

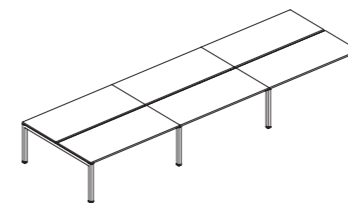

composizione bench per 6 persone
bench composition for 6 people
poste de travail pour 6 personnes
Arbeitsplatz für 6 personen
samestelling bench voor 6 plaatsen
composicion bench para 6 personas

L x P x H

420 x 164 x 72 cm



cassettiera · pedestals · caissons
container · ladenblok · cajonera

42 x 56 x 59 cm



cassettiera · pedestals · caissons
container · ladenblok · cajonera

42 x 56 x 59 cm



armadio · cabinet · armoire
Schränk · kast · armario

100 x 46 x 119,6 cm

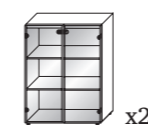

armadio · cabinet · armoire
Schränk · kast · armario

100 x 46 x 119,6 cm

gate job-sharing

Configurare postazioni di lavoro condivise lineari o sagomate in maniera ottimale grazie alla componibilità della struttura.

The modular structure enables you to organise shared linear or shaped workstations in the best way possible.

La modularité de la structure permet de réaliser des postes de travail partagés linéaires ou profilés de façon optimale.

Geteilte Arbeitsplätze linear oder in Formzusammenstellungen optimal konfigurieren, dank der Komponibilität der Struktur.

Lineaire of gevormde gemeenschappelijke werkstations worden optimaal geconfigureerd dank zij de samenstelling van de structuur.

Configurar puestos de trabajo compartidas lineales o perfiladas de forma óptima gracias a la estructura componible



*melaminico bianco, alluminio,
laccato nero*

*white melamine, aluminium,
black lacquered*

*mélatiné blanc, aluminium,
laqué noir*

*Melamin weiß, Aluminium,
Schwarz lackiert*

*melamine wit, aluminium,
gelakt zwart*

*melamina blanco, aluminio,
laqueado negro*



01 | PORTA MONITOR
MONITOR STAND
PORTE-ÉCRAN
MONITORTRÄGER
MONITORSTEUN
PARA MONITOR

02 | SCHERMO PER SCRIVANIA BENCH
SCREEN FOR BENCH DESK
ÉCRAN PRIVATIF POUR BUREAU BENCH
SCHREIBTISCHSCHUTZSCHIRM BENCH
BUREAUSCHERM BENCH
PANEL PARA ESCRITORIO BENCH

gate

a place for everything

*melaminico bianco e tortora,
alluminio, laccato deep teal*

*white and turtledove
melamine, aluminium, deep
teal lacquered*

*mélaminé blanc et tourterelle,
aluminium, laqué bleu canard*

*Melamin Weiß und
taubengrau, Aluminium, Deep
Teal lackiert*

*melamine wit en tortelduif,
aluminium, gelakt deep teal*

*melamina blanco y tórtola,
aluminio, laqueado deep teal*



01.02 | CASSETTINO SOTTOCRIVANIA · DRAWER UNDER DESK · TIROIR SOUS LE BUREAU · SCHUBLADE UNTER SCHREIBTISCH · LADE ONDER DESK · CAJON DE DEBAJO DEL ESCRITORIO



gate

flexible &
reconfigurable



melaminico bianco, bianco

white melamine, white

mélaminé blanc, blanc

Melamin weiß, weiß

melamine wit, wit

melamina blanco, blanco

Unione perfetta tra forma e funzione.
Con elementi semplici ed eleganti si
trasforma lo spazio singolo in spazio
riunione e di relazione.

Perfect union between form and function.
Simple, elegant elements transform an
individual workspace into a meeting and
conversational area.

Association parfaite de forme et fonction.
Avec des éléments simples et élégants,
l'espace individuel se transforme en
espace de réunion et de relation.

Perfekte Vereinigung von Form und Funktion.
Mit einfachen und eleganten Elementen
verwandelt sich der Einzelplatz in einen
Besprechungs- und Berichterstattungsbereich.

Perfekte unie tussen vorm en functie. Met
eenvoudige en elegante elementen,
wordt de afzonderlijke ruimte omgevormd
tot een vergader- en relatieruimte.

Unión perfecta entre forma y función.
Con elementos simples y elegantes se
transforma el espacio simple en espacio
reunión y de relación.

*melaminico bianco, alluminio,
laccato verde muschio*

*white melamine, aluminium,
moss green lacquered*

*mélaminé blanc, aluminium,
laqué vert mousse*

*Melamin weiß, Aluminium,
Moosgrün lackiert*

*melamine wit, aluminium,
gelakt Mosgroen*

*melamina blanco, aluminio,
laqueado verde musgo*



gate

composition elements & dimensions

20

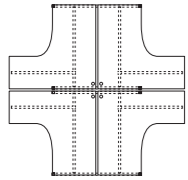

posto di lavoro · workstation
Poste de travail · arbeitsplatz
werkplek · puesto de trabajo

L x P x H

324 x 324 x 72 cm



x4

cassettiera · pedestals · caissons
container · ladenblok · cajonera

42 x 56 x 59 cm

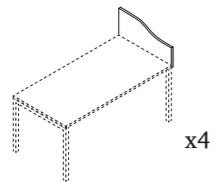

x4

schermo · screen · écran
Bildschirm · scherm · pantalla

80 x 1,8 x 40 cm

23

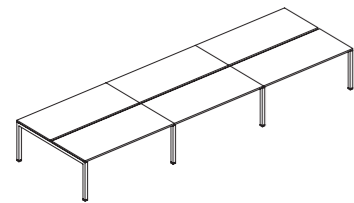

composizione bench per 6 persone
bench composition for 6 people
poste de travail pour 6 personnes
Arbeitsplatz für 6 personen
samestelling bench voor 6 plaatsen
composicion bench para 6 personas

L x P x H

420 x 164 x 72 cm

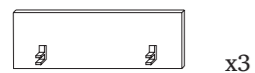

x3

schermo · screen · écran
Bildschirm · scherm · pantalla

80 x 1,8 x 40 cm

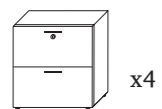

x4

armadio · cabinet · armoire
Schränk · kast · armario

80 x 46 x 81,2 cm

24

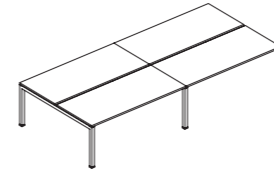

composizione bench per 4 persone
bench composition for 4 people
poste de travail pour 4 personnes
Arbeitsplatz für 4 personen
samestelling bench voor 4 plaatsen
composicion bench para 4 personas

L x P x H

280 x 164 x 72 cm

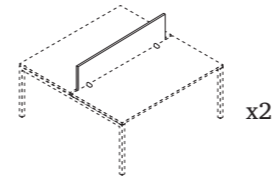

x2

schermo · screen · écran
Bildschirm · scherm · pantalla

120 x 1,8 x 40 cm

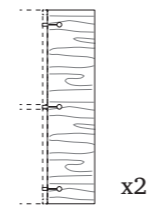

x2

elemento terminale · end element
element terminal · endplatte
eindelement · elemento terminal

40 x 164 x 2,5 cm



x2

cassettiera · pedestals · caissons
container · ladenblok · cajonera

42 x 56 x 59 cm

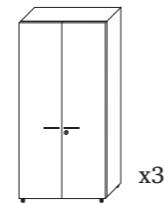

x3

armadio · cabinet · armoire
Schränk · kast · armario

100 x 46 x 196,4 cm

25

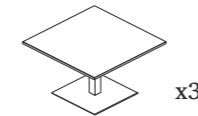

x3

tavolo · table · tableau
tisch · tafel · mesa

L x P x H

300 x 100 x 72 cm

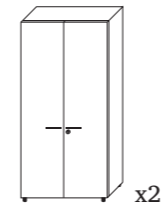

x2

armadio · cabinet · armoire
Schränk · kast · armario

100 x 46 x 196,4 cm

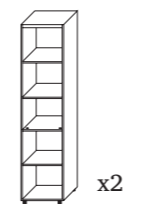

x2

armadio · cabinet · armoire
Schränk · kast · armario

50 x 46 x 196,4 cm

gate height regulation system

*melaminico bianco, alluminio
e nero, alluminio, vetro
temperato satinato.*

*white, aluminium and black
melamine, aluminium, frosted
tempered glass.*

*mélaminé blanc, aluminium et
noir, aluminium, verre trempé
satiné.*

*Melamin Weiß, Aluminium
und Schwarz, Aluminium,
mattier Temperiertes Glas.*

*melamine wit, aluminium en
zwart, aluminium, gehard glas
gesatineers.*

*melamina blanco, aluminio
y negro, aluminio, vidrio
templado satinado.*



01 | SEZIONE GAMBA CON KIT DI REGOLAZIONE IN ALTEZZA
THE SECTION OF THE FOOT WITH HEIGHT-ADJUSTMENT KIT
SECTION DE LE PIED AVEC KIT DE RÉGLAGE EN HAUTEUR
DER QUERSCHNITT FUSS MIT DAS KIT ZUR HÖHENVERSTELLUNG
DER BEIN MIT DAS KIT ZUR HÖHENVERSTELLUNG VON 62 BIS 86 CM
DE POOT MET HOOGTEVERSTELLING KIT VAN 62 TOT 86 CM
SECCIÓN DEL PIE CON KIT DE REGULACIÓN EN ALTURA

02 | GAMBA CON KIT DI REGOLAZIONE IN ALTEZZA DA 62 A 86 CM
LEG WITH HEIGHT-ADJUSTMENT KIT FROM 62 TO H. 86 CM
PIED AVEC KIT DE RÉGLAGE EN HAUTEUR DE 62 À 86 CM
DER BEIN MIT DAS KIT ZUR HÖHENVERSTELLUNG VON 62 BIS 86 CM
DE POOT MET HOOGTEVERSTELLING KIT VAN 62 TOT 86 CM
PATA CON KIT DE REGULACIÓN EN ALTURA DE 62 A 86 CM

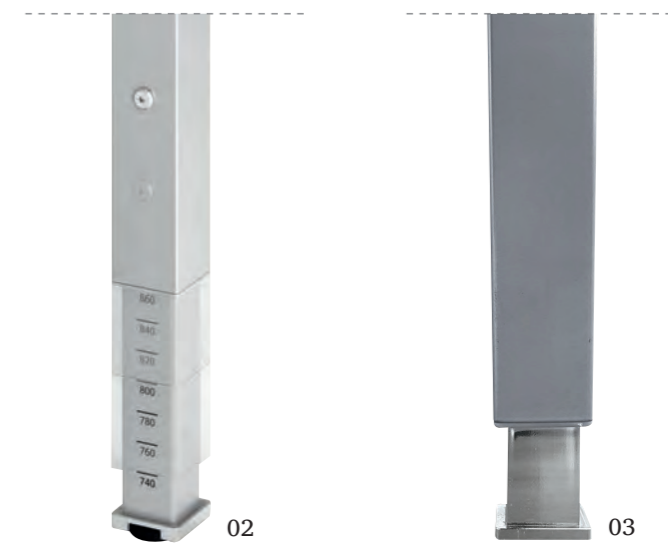

03 | PIEDINO STANDARD CHE PERMETTE UNA REGOLAZIONE IN ALTEZZA
DA 72 A 77 CM
THE STANDARD FOOT ALLOWS A HEIGHT-ADJUSTMENT FROM 72 TO H. 77 CM
LE PIED STANDARD PERMET UN RÉGLAGE EN HAUTEUR DE 72 À 77 CM
DER STANDARD FUSS GESTATTET HÖHENVERSTELLUNG VON 72 BIS 77 CM
DEZE STANDAARD-POOT STAAT HOOGTEVERSTELLING VAN 72 TOT 77 CM
EL PIE ESTÁNDAR PERMITE UNA REGULACIÓN EN ALTURA DE 72 A 77 CM

gate cabling system

Diverse tipologie di accessori aiutano a personalizzare lo spazio. Un sistema di elettrificazione funzionale consente il cablaggio del posto lavoro.

Different types of accessories help to personalise the workspace. A practical electrification system enables workstations to be wired up.



Différents types d'accessoires contribuent à personnaliser l'espace. Un système d'électrification fonctionnel permet le câblage du poste de travail.

Verschiedene Typologien von Zubehör helfen bei der individuellen Abstimmung des Raums. Ein funktionelles Elektrifizierungssystem ermöglicht die Verkabelung des Arbeitsplatzes.

Verschillende soorten toebehoren helpen de verpersoonlijking van de ruimte. Een functioneel elektrificatiesysteem staat de bedrading van de werkplaats toe.

Varios tipos de accesorios ayudan a personalizar el espacio. Un sistema de electrificación funcional permite el cableado del lugar de trabajo.



01



02



03



05



04



06

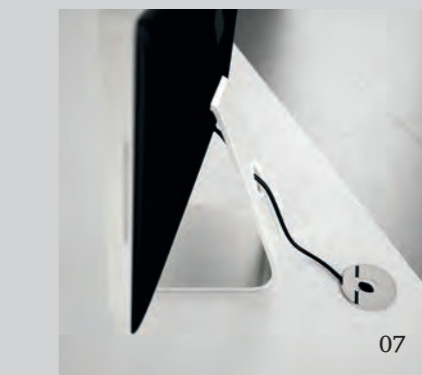

07

01.02 | BLOCCO PORTAPRESE VERSAPAD · FOLDWAY SOCKET HOLDER VERSAPAD · BOÎTES DE PRISES VERSAPAD · STECKDOSENBLOCK VERSAPAD · INGEWERKTE CONTACTDOOS VERSAPAD · BASE DE CONEXIONES VERSAPAD

03 | TOP ACCESS E VASCHETTA · TOP ACCESS AND WIRE TRAY · ACCÈS SUPÉRIEUR ET PORTILLON · TOP-ZUGANG UND KLAPPEN · TOP TOEGANG EN KLEP · ACCESO SUPERIOR Y PUERTAS

04 | PASSACAVI IN LAMIERA · CABLES HOLDER BASKETS · BAC PORTE-CABLES · KABEL HALTERKÖRBCHEIN · DRAAIBARE · CESTOS PORTAENCHUFES

05 | COLONNINA SALITA CAVI AUTONOMA · SELF-STANDING CABLE · RISER COLUMN · COLONNE MONTÉE CÂBLES AUTONOME · AUTONOME SÄULE ZUR AUFWÄRTSVERLEGUNG VON KABELN · KOLOM VOOR AUTONOME STIJGING VAN DE KABELS · COLUMNNA DE SUBIDA DE LOS CABLES AUTÓNOMA

06 | CESTELLI PORTACAVI E PASSACAVI · CABLES HOLDER BASKETS AND CABLESCARRIER · BAC PORTE-CABLES ET PASSAGE DE CÂBLES · KABEL HALTERKÖRBCHEIN UND KABELDURCHLASS · KORFJES VOOR ELECTRISCHE BEDRADING EN DRAADLEIDER · CESTOS PORTAENCHUFES Y PASACABLES

07 | TAPPO PASSACAVI · DESKTOP CABLE ROUTING PLUG · BOUCHON PASSE-CABLE · KABELDURCHLASS · KABELDOORGANGDOP · TAPÓN PASACABLES

*melaminico rovere naturale e
bianco, alluminio, laccato deep teal*

*natural oak and white melamine,
aluminium, deep teal lacquered*

*mélaminé chêne naturel et blanc,
aluminium, laqué deep teal*

*Melamin natur Eiche und Weiß,
Aluminium, Deep Teal lackiert*

*melamine eikenhout natuur en wit,
aluminium, gelakt deep teal*

*melamina roble natural y blanco,
aluminio, laqueado deep teal*



Gate risolve ogni necessità; scrivania
singola, scrivanie condivise creano
contesti di lavoro che rispettano individuo
e operatività con l'utilizzo dei piani
da 25 o 30 mm.

Gate satisfait toutes les nécessités;
bureau individuel, bureaux partagés,
créant des ambiances qui respectent
individu et travail, par l'utilisation des
plateaux de 25 ou 30 mm.

Gate wird allen Anforderungen gerecht:
Einzel- und Teamarbeitsschreibische
kreieren Arbeitskontexte, die das
Individuum und die Operativität
respektieren, mit dem Einsatz der 25
oder 30 mm dicken Tischplatten.

Gate solves all your requirements.
Individual and shared desks with the
25 or 30 mm thick tops create working
environments that respect people and the
work they do.

Gate beantwoordt aan alle behoeften;
afzonderlijke of gemeenschappelijke
werktafels creëren werkomgevingen
die zowel het individu als de
bedrijfsgeredheid respecteren, dank zij
de vlakken van 25 of 30 mm.

Gate soluciona cualquier necesidad; el
escritorio simple y los escritorios
compartidos crean contextos de trabajo
que respetan al individuo y la operatividad
con el uso de los planos de 25 o 30 mm.



*melaminico rovere naturale e
alluminio, alluminio, laccato
titanio*

*natural oak and on color
aluminium melamine,
aluminium, titanium lacquered*

*mélaminé chêne naturel et sur
teinte aluminium, aluminium,
laqué titane*

*Melamin natur Eiche und
Aluminium Farbe, Aluminium,
Titan lackiert*

*melamine op kleur eikenhout
natuur en aluminium, aluminium,
gelakt titanium*

*melamina roble natural y con
color aluminio, aluminio, laqueado
titanio*

gate

composition elements & dimensions

28

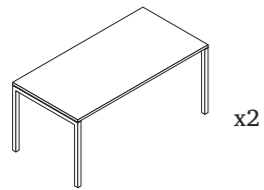

scrivania · desk · bureau
Schreibtisch · bureau · escritorio

L x P x H
160 x 80 x 72 cm

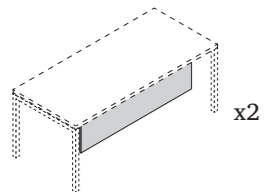

modesty panel · modesty panel
voile de fond · Schreibtischblende
bureaubord · panel

136 x 1,8 x 31 cm



mobile di servizio · service module
meuble de service · Service-Mobel
dienstmodule · mueble de servicio

92 x 56 x 59 cm

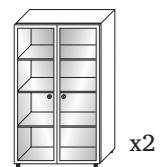

armadio · cabinet · armoire
Schränk · kast · armario

100 x 46 x 158 cm

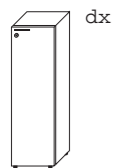

armadio · cabinet · armoire
Schränk · kast · armario

50 x 46 x 158 cm

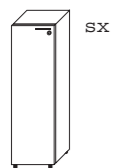

armadio · cabinet · armoire
Schränk · kast · armario

50 x 46 x 158 cm

32

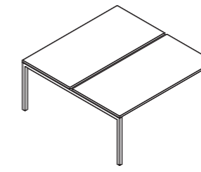

composizione bench · bench composition
poste de travail · Arbeitsplatz
samestelling bench · composition bench

L x P x H
180 x 164 x 72 cm

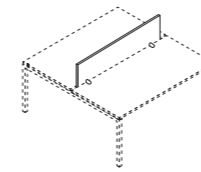

schermo · screen · écran
Bildschirm · scherm · pantalla

160 x 1,8 x 40 cm



cassetiera · pedestals · caissons
container · ladenblok · cajonera

45 x 56 x 59 cm

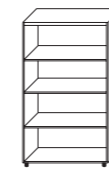

armadio · cabinet · armoire
Schränk · kast · armario

100 x 46 x 158 cm

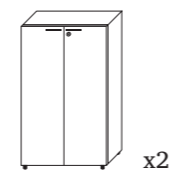

armadio · cabinet · armoire
Schränk · kast · armario

100 x 46 x 158 cm

33

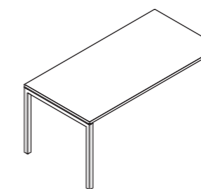

scrivania · desk · bureau
Schreibtisch · bureau · escritorio

L x P x H
180 x 80 x 72 cm

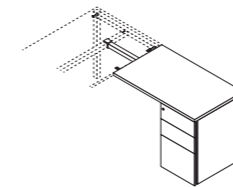

datilo con cassetiera portante
hanging additional desk with support
pedestal dactylo avec caisson portant
Hangender tischmodul mit Schubladenkasten
opleghulptafel met ladenblock
ala colgante con cajonera de sustentacion

120 x 60 x 72 cm

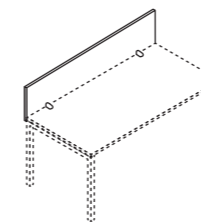

schermo · screen · écran
Bildschirm · scherm · pantalla

80 x 1,8 x 40 cm

*melaminico wengé, nero e alluminio,
alluminio, vetro temperato grigio.*

*wengé, black and on color aluminium
melamine, aluminium, grey tempered glass.*

*mélaminé wengé, noir et sur teinte
aluminium, aluminium, verre trempé gris.*

*Melamin Wengé, Schwarz und
Aluminium Farbe, Aluminium, Grau
Temperiertes Glas.*

*melamine op kleur wengé, zwart en
aluminium, aluminium, gehard glas grijs.*

*melamina wengé, negro y con color
aluminio, aluminio, vidrio templado gris.*



gate

combinabile & reconfigurabile

È facile risolvere necessità di ruoli e destinazioni creando spazi più adeguati a ciascuna mansione. La finitura in acero ingentilisce lo spazio.

The requirements of roles and positions are easily met by creating more appropriate spaces for each task. The maple finish gives a more refined appearance.

Il est facile de répondre aux nécessités des rôles et usages, créant des espaces plus adaptés à chaque fonction. La finition en érable ennoblit l'espace.

Es ist leicht, eine Lösung für die Erfordernisse von Rollen und Bestimmungen zu finden, indem geeigneter Raum für jede Aufgabe kreiert wird. Die Ahorn-Ausführung gestaltet den Raum freundlicher.

Rol- en bestemmingsbehoefen worden gemakkelijk beantwoord door ruimtes te creëren die geschikt zijn voor iedere functie. De afwerking in esdoorn verfijnt de ruimte.

Es fácil resolver necesidades de roles y de destinos creando espacios más adecuados a la función de cada uno. El acabado de acero suaviza el espacio.

melaminico acero, alluminio, laccato bordeaux

maple melamine, alluminio, bordeaux lacquered

mélaminé érable, aluminium, laqué bordeaux

Melamin Ahorn, Aluminium, bordeaux lackiert

melamine esdoorn, aluminium, gelakt bordeaux

melamina arce, aluminio, laqueado burdeos



gate

composition elements & dimensions

36/37

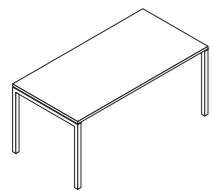

scrivania · desk · bureau
Schreibtisch · bureau · escritorio

L x P x H

180 x 80 x 72 cm

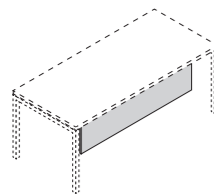

modesty panel · modesty panel
voile de fond · Schreibtischblende
bureaubord · panel

156 x 1,8 x 31 cm



mobile di servizio · service module
meuble de service · Service-Möbel
dienstmodule · mueble de servicio

92 x 56 x 59 cm

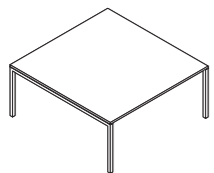

tavolo · table · tableau
tisch · tafel · mesa

124 x 124 x 72 cm

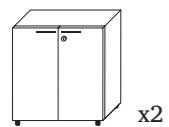

armadio · cabinet · armoire
Schränk · kast · armario

80 x 46 x 81,2 cm

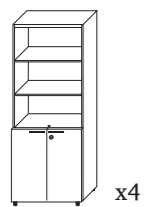

armadio · cabinet · armoire
Schränk · kast · armario

80 x 46 x 196,4 cm

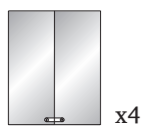

coppie ante sopralzo · pair of upper doors
paire portes haut · paar obere türen
set bovenste deuren · par de puertas superior

79,6 x 0,5 x 114,8 cm

38

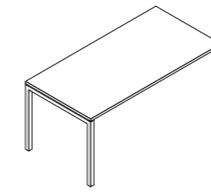

scrivania · desk · bureau
Schreibtisch · bureau · escritorio

L x P x H

140 x 80 x 72 cm

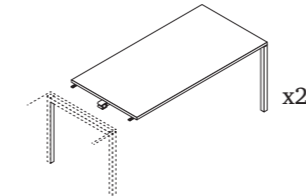

scrivania per aggregazioni lineari

140 x 80 x 72 cm

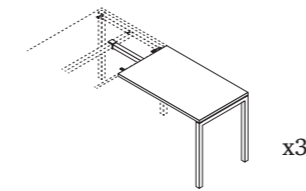

dattilo appeso · hanging additional desk
dactylo suspendue · hangender Tischmodul
opleghulptafel · ala colgante

100 x 60 x 72 cm

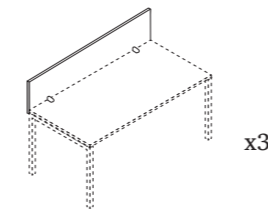

schermo · screen · écran
Bildschirm · scherm · pantalla

80 x 1,8 x 40 cm

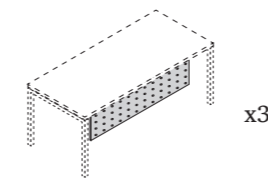

modesty panel · modesty panel
voile de fond · Schreibtischblende
bureaubord · panel

116 x 0,2 x 31 cm

39

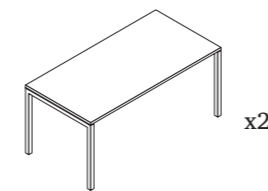

scrivania · desk · bureau
Schreibtisch · bureau · escritorio

160 x 80 x 72 cm

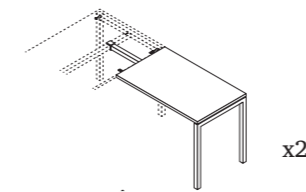

dattilo appeso · hanging additional desk
dactylo suspendue · hangender Tischmodul
opleghulptafel · ala colgante

80 x 60 x 72 cm

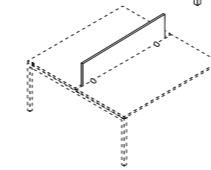

schermo · screen · écran
Bildschirm · scherm · pantalla

80 x 1,8 x 40 cm

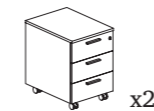

cassettiera · pedestals · caissons
container · ladenblok · cajonera

42 x 56 x 59 cm

melaminico bianco, nero e alluminio,
metallo alluminio

white, black and on color aluminium
melamine, aluminium

mélaminé blanc, noir et sur teinte
aluminium, aluminium

Melamin Weiß, Schwarz und Aluminium
Farbe, Aluminium

melamine op kleur wit, zwart en
aluminium, aluminium

melamina blanco, negro y con color
aluminio, aluminio



gate

ergonomic
shapes to
work better



Forme lineari e sagomate, componibilità,
consentono di creare situazioni ogni
volta all'altezza della funzione più
operativa o direttiva.

Linear and shaped forms and modular
units create situations that always live up
to working or managerial requirements.

Des formes linéaires et profilées, des
éléments modulaires, permettent de créer
des espaces pour toutes les fonctions,
aussi bien opérationnelles que de direction.

Lineare und geformte Gestaltung,
Komponibilität gestatten es, Situationen
zu kreieren, die stets auch der
anspruchsvollsten operativen oder
direktiven Funktion gewachsen sind.

Lineaire en gevormde vormen,
samenstelbaarheid, staan toe situaties
te creëren die van keer tot keer geschikt
zijn voor de meest operationele of
directie-functie.

Formas lineales y perfiladas, estructura
componible, permiten crear situaciones
siempre a la altura de la función más
operativa o directiva.

*melaminico bianco e nero, bianco,
vetro temperato satinato.*

*white and black melamin, white,
frosted tempered glass.*

*mélaminé blanc et noir, blanc
et verre trempé satiné.*

*Melamin weiß und Schwarz,
weiß, mattier Temperiertes Glas.*

*melamine wit en zwart, wit,
gehard glas gesatineers.*

*melamina blanco y negro,
blanco, vidrio templado satinado.*



gate

composition elements & dimensions

42

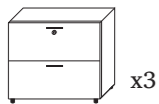
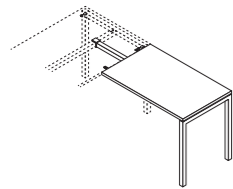
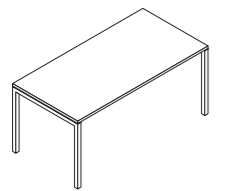

scrivania · desk · bureau
Schreibtisch · bureau · escritorio

dattilo appeso · hanging additional desk
dactylo suspendue · hangender Tischmodul
opleghulptafel · ala colgante

cassettiera · pedestals · caissons
container · ladenblok · cajonera

armadio · cabinet · armoire
Schränk · kast · armario

L x P x H

180 x 80 x 72 cm

80 x 60 x 72 cm

42 x 56 x 59 cm

100 x 46 x 81,2 cm

43

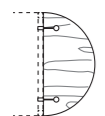
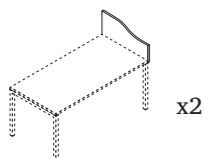
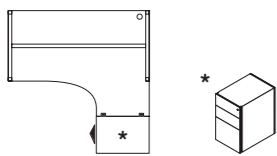

scrivania compact con cassettiera e top
Compact desk with pedestal and top
Bureau compact avec caisson portant et top
Kompaktschreibtisch mit tragendem Container
und Top · Bureau compact met dragend
ladenblok en top · Escritorio compact con
cajonera y parte superior

schermo laterale · lateral screen
écran lateral · llateral-Bildschirm
zijdelings scherm · pantalla lateral

elemento terminale · end element
element terminal · endplatte
eindelement · elemento terminal

L x P x H

160 x 162 x 72 cm

80 x 1,8 x 40 cm

40 x 80 x 2,5 cm

44/45

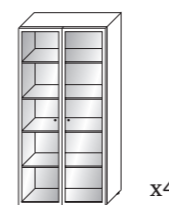
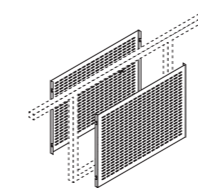
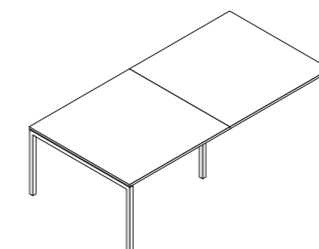
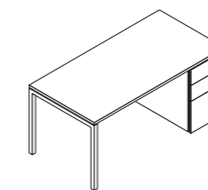
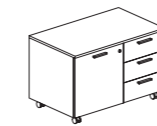
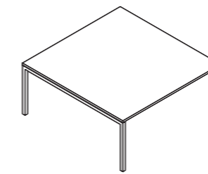

tavolo · table · tableau
tisch · tafel · mesa

mobile di servizio · service module
meuble de service · Service-Mobel
dienstmodule · mueble de servicio

scrivania con cassettiera portante
desk with support pedestal
bureau avec caisson portant
Schreibtische mit Schubladenkasten
bureaus met ladenblok
escritorio con cajonera de sustentacion

tavolo · table · tableau
tisch · tafel · mesa

coppia pannelli di tamponamento
pair of closure panels
paire de panneaux de remplissage
paar ausfachungsplatten
koppel verbindingspanelen
par de paneles de taponado

armadio · cabinet · armoire
Schränk · kast · armario

L x P x H

164 x 164 x 72 cm

92 x 56 x 59 cm

140 x 80 x 72 cm

248 x 124 x 72 cm

71 x 2 x 61 cm

100 x 46 x 196,4 cm

gate archiving

Diverse forme, tipologie, usi e capacità fanno del contenimento A100 un elemento fondamentale per il completamento dell'offerta Gate.

Different shapes, types, uses and capacities make the A100 storage units an essential part of the Gate office range.

Différentes formes, types, utilisations et capacité font du meuble de rangement A100 un élément fondamental, complétant l'offre de Gate.

Verschiedene Formen, Typologien, Nutzungsmöglichkeiten und Kapazitäten lassen das Behältermöbel A100 zu einem grundlegenden Element zur Vervollständigung des Angebots Gate werden.

Verschillende vormen, types, toepassingen en capaciteiten maken van de houders A100 een fundamenteel element voor de vervollediging van de offerte Gate.

Varias formas, varios tipos, varios usos y varias capacidades hacen del contenedor A100 un elemento fundamental para completar la oferta Gate.



H 196,4

H 158

H 81,2



01 | COD. AZ.9503.00 BARRE PORTACARTELLE PER RIPIANO (CARTELLE DA 33 CM) · FILE CARRIER BARS FOR SHELF (33 CM FILES) · BARRES PORTE-DOSSIERS POUR ÉTAGÈRE (DOSSIERS DE 33 CM) · HÄNGEREGISTERTRÄGER FÜR ABLAGEFACH (33 CM HÄNGEREGISTERTRÄGER) · DOSSIERDRAGENDE STAVEN VOOR ELEGLANK (33 CM DOSSIERDRAGENDE) · PARRAS PORTACARPETAS PARA ESTANTE (CARPETAS DE 33 CM)

02 | COD. AZ.0904.00 TELAIO PORTACARTELLE ESTRAIBILE · PULL-OUT FRAME FOR SUSPENDED FILES · CADRE EXTRACTIONNELLE POUR DOSSIERS SUSPEND · AUSZUGSRAMMEN FÜR HÄNGEMAPPEN · FRAME UITTREKBAAR VOOR HANGMAPPEN · BASTIDOR EXTRAIBILE PARA ARCHIVOS SUSPENDIDOS

03 | RIPIANO DA 25 MM · 25 MM SHELF · ÉTAGÈRE DE 25 MM · 25 MM EINLEGEBODEN · PLANK VAN 25 MM · ESTANTE DE 25 MM

04 | LA TENUTA ALLA CHIUSURA DELL'ANTA, È GARANTITA DA UN'ASTA IN METALLO CHE CORRE LUNGO TUTTA L'ALTEZZA DELL'ANTA STESSA · THE PERFECT CLOSING OF THE DOORS IS ENSURED BY A METAL ROD WHICH EXTENDS FOR THE ENTIRE LENGTH OF THE DOOR · LA TENUE À LA FERMETURE DE LA PORTE EST GARANTIE PAR UNE BARRE EN MÉTAL SUR TOUTE LA HAUTEUR DU VANTAIL · DIE SCHLIESSDICHTIGKEIT DER TÜREN WIRD DURCH EINE METALLSTANGE GARANTIERT, DIE ENTLANG DER GESAMTEN TÜRHÖHE VERLÄUFT · DE CORRECTE SLUITING VAN DE DEUR WORDT GEGARANDEERD DOOR EEN METALEN STAAF DIE LANGS DE VOLLEDIGE LENGTE VAN DE DEUR LOOPT · LA RESISTENCIA AL CIERRE DE LA PUERTA, ESTÁ GARANTIZADA POR UNA VARILLA DE METAL QUE CORRE A LO LARGO DE TODA LA ALTURA DE LA PUERTA EN CUESTIÓN

05 | COD. AZ.1000.00 BARRA DI RINFORZO PER PIANI INTERMEDI PER ARMADI · REINFORCED BAR FOR CABINET INTERMEDIATE SHELVES · BARRE DE RENFORCEMENT POUR PLATEAUX INTERMÉDIAIRES POUR ARMOIRE · VERSTÄRKUNG FÜR SCHRANK-ZWISCHENFÄCHER · VERSTEVIINGSPROEDEL VOOR TUSSENPLANK · BARRA DE REFUERZO PARA PLANOS INTERMEDIOS PARA ARMARIO

06 | COD. MA.1210.01 MANIGLIA IN ABS · ABS HANDLE · POIGNÉE EN ABS · ABS GRIFF · ABS HANDGREEP · MANILLA ABS

07 | COD. AZ.0400.00 L'ORGANIZZAZIONE INTERNA DELL'ARMADIO PUÒ PREVEDERE L'APPLICAZIONE DI UN RILOGA APPENDIABILI · THE CABINETS CAN ALSO BE EQUIPPED WITH A COAT POLE · L'ORGANISATION INTERNE DE L'ARMOIRE PEUT PRÉVOIR L'APPLICATION D'UNE TRINGLE À VÊTEMENTS · IM INNEREN DES SCHRANKS IST DIE UNTERBRINGUNG EINER KLEIDERSTANGE MÖGLICH · DE BINNENKANT VAN DE KAST IS ZODANIG INGERICHT DAT U EEN KAPSTOK KUNT AANBRENGEN · LA ORGANIZACIÓN INTERNA DEL ARMARIO PUEDE LLEVAR LA APLICACIÓN DE UN LISTÓN PARA COLGAR ROPA

08 | COD. AZ.0405.00 NEI MODULI CON LARGHEZZA 500 MM È POSSIBILE INSERIRE IL MINIFRIGORIFERO 405x410x505 MM (LXPXH). IL VANO È GIÀ PREDISPOSTO CON UNA PRESA D'ARIA FRESATA SULLA SCHIENA · THE 500 MM LARGE MODULES CAN BE EQUIPPED WITH A MINI FRIDGE 405x410x505 MM (WXLXH). THE CABINET IS ALREADY FITTED WITH A MILLED GRILLE ON THE BACK · DANS LES MODULES DE 500 MM DE LARGEUR, IL EST POSSIBLE D'ENCASTRER LE MINI RÉFRIGÉRATEUR 405x410x505 MM (LXPXH). LE COMPARTIMENT PRÉVOIT DÉJÀ UNE PRISE D'AIR OBTENUE PAR FRAISAGE DU PANNEAU ARRIÈRE · IN DEN MODULEN MIT 500 MM BREITE IST PLATZ FÜR DEN MINIKÜLSCHRANK 405x410x505 MM (LXPXH). DAS FACH IST BEREITS MIT EINEM IN DIE RÜCKSEITE EINGEFRASTEN LÜFTUNGSSCHACHT VERSEHEN · IN MODULES DIE 50 CM BREED ZIJN, KUNT U DE MINIKOELKAST 405x410x505 MM (PXLXH) PLAATSEN. DE DESBETREFFENDE RUIMTE BESCHIKT REEDS OVER EEN VENTILATIEOPENING AAN DE ACHTERKANT · EN LOS MÓDULOS CON ANCHO DE 50 CM SE PUEDE METER UNA NEVERA PEQUEÑA 405x410x505 MM (FXAXA). EL HUECO YA ESTÁ PREPARADO CON UNA TOMA DE AIRE FRESADA EN LA PARTE POSTERIOR.

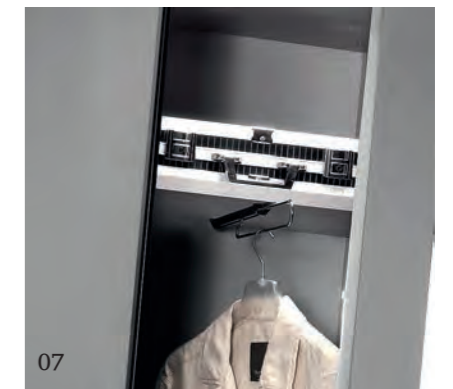

gate accessories

Vasta gamma di cassettiere e moduli di servizio in legno. Possono avere, optional, la vaschetta in abs con funzione portacancelleria.

The range comprises a wide selection of drawer units and accessory modules in wood. They may be fit with an optional small tray in abs for storing stationery.

Vaste gamme de caissons à tiroirs et de dessertes en bois. Ils peuvent avoir, en option, la boîte en abs pour les fournitures de bureau.

Große Auswahl an Schubladenelementen und Hilfsmodulen aus Holz. Als Extras ist eine ABS-Schale zur Aufnahme von Schreibartikeln erhältlich.

Ruim assortiment ladenblokken en servicemodules van hout. Met als optie een bakje van abs uitgevoerd als pennenbakje.

Amplia gama de cajoneras y módulos de servicio de madera. Pueden tener, opcionalmente, la bandeja de abs con función portapapelería.



L 42

CASSETTIERE STRUTTURALI SERIE NEW · SUPPORT PEDESTALS OF THE NEW SERIES · CAISSONS PORTANTS DE LA SÉRIE NEW · TRAGENDEN SCHUBLADENKÄSTEN DER SERIE NEW NACH · DRAGEND LADENBLOKKEN VAN DE SERIE NEW · CAJONES DE SUSTENTACIÓN DE LA SERIE NEW



L 42

CASSETTIERE FREESTANDING SERIE NEW · FREE STANDING PEDESTALS OF THE NEW SERIES · CAISSONS AUTOPORTANTES DE LA SÉRIE NEW · FREISTEHEND SCHUBLADENKÄSTEN DER SERIE NEW NACH · VRIJSTAAND LADENBLOKKEN VAN DE SERIE NEW · CAJONES INDEPENDIENTE DE LA SERIE NEW



L 32

CASSETTIERE FREESTANDING SERIE NEW · FREE STANDING PEDESTALS OF THE NEW SERIES · CAISSONS AUTOPORTANTES DE LA SÉRIE NEW · FREISTEHEND SCHUBLADENKÄSTEN DER SERIE NEW NACH · VRIJSTAAND LADENBLOKKEN VAN DE SERIE NEW · CAJONES INDEPENDIENTE DE LA SERIE NEW



L 42



L 42



L 92



L 142

CASSETTIERE SERIE EKO · PEDESTALS OF THE EKO SERIES · CAISSONS DE LA SÉRIE EKO · CONTAINER DER SERIE EKO · LADENBLOKKEN VAN DE SERIE EKO · CAJONERAS DE LA SERIE EKO

finishes

melaminici · melamine · mélamine
Melamin · melamince · melamina | 25 mm



BL	GP	AC	MK
bianco white blanc Weiß wit blanco	grigio perla pearl-grey gris perle perlgrau parelgrijs gris perla	acero maple érable Ahorn esdoorn arce	nero black noir Schwarz zwart negro

melaminici · melamine · mélamine
Melamin · melamince · melamina | 30 mm

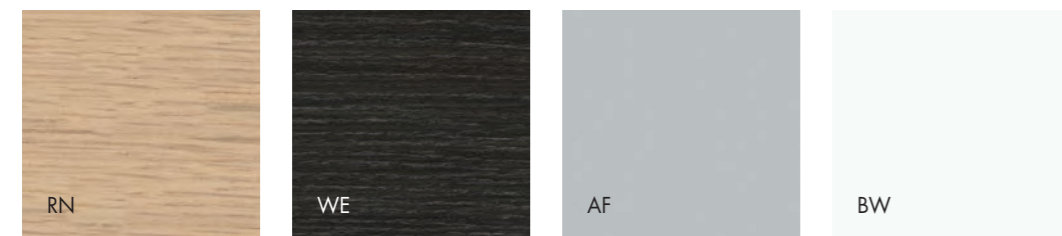

RN	WE	AF	BW
rovere naturale natural oak chêne naturel Natur Eiche eikenhout natuur roble natural	wengé wengé Wengé wengé wengé	verniciato epox alluminio aluminium epoxy painted peint epoxy aluminium pulverbeschichtung aluminium aluminiumkleur geepoxeerd pintado epoxidico aluminio	verniciato epox bianco white epoxy painted peint epoxy blanc pulverbeschichtung weiß geépoxeerd wit pintado epoxidico blanco

ante vetro · glass doors · portes en verre · türen glas · glazen deurtjes · puertas de vidrio
| vetro temperato · tempered glass · verre trempé · Temperiertes Glas · gehard glas · vidrio templado

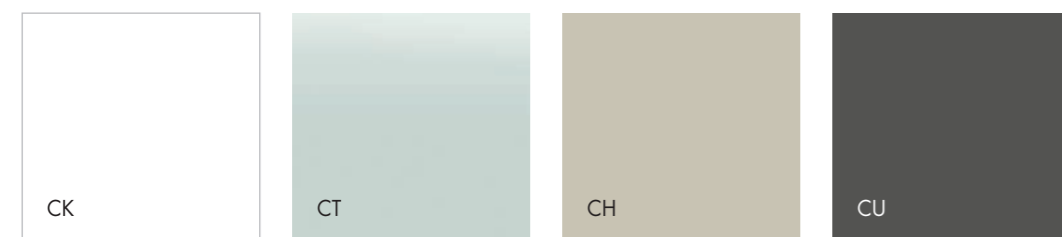

CK	CT	CH	CU
trasparente transparent transparent transparentes transparente transparente	satinato frosted satiné mattier gesatineers satinado	nebbia mist brouillard Nebelgrau mist niebla	titanio titanium titane Titan titanium titanio



VG	CB	CO	CN
grigio grey gris Grau grijs gris	bianco white blanc Weiß wit blanco	tortora turtledove tourterelle Turteltaube tortelduif törtola	nero black noir Schwarz zwart negro

finishes

ante vetro · glass doors · portes en verre · türen glas · glazen deurtjes · puertas de vidrio
| vetro temperato opaco · tempered matt glass · verre trempé opaque · Matt temperiertes Glas · mat gehard glas · vidrio templado mate

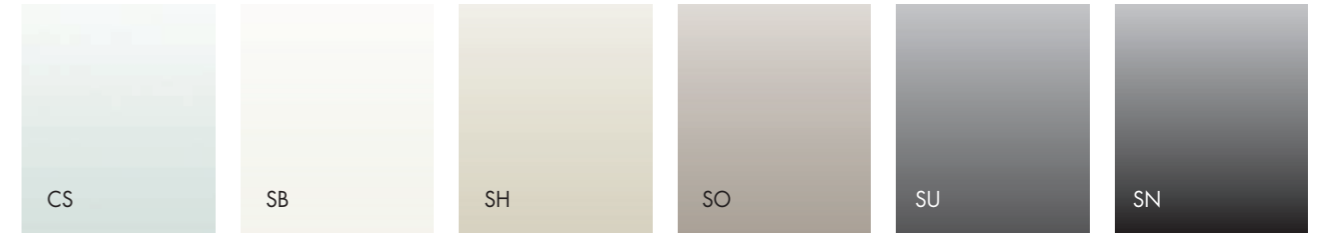

CS	SB	SH	SO	SU	SN
bi-satinato frosted on both side satiné sur le 2 faces beidseitig satiniertes tweezijding gesatineers bi-satinado	bianco white blanc Weiß wit blanco	nebbia mist brouillard Nebelgrau mist niebla	tortora turtledove tourterelle Turteltaube tortelduif törtola	titanio titanium titane Titan titanium titanio	nero black noir Schwarz zwart negro

schermi - armadi: ante, tops e fianchi di finitura · screens - cabinets: doors, tops and closing sides · cloisonnettes - armoires: portes, tops et flancs de fermeture · sichtschutzpaneele - schränke: türen, platten und abschlussflanken · schermen - kasten: deur, top en zijpanelen · pantallas - armarios: puertas, partes superiores y costados de cierre | laccati · lacquered · laqués · Lackiertes · gelakt · laqueado



LB	L3	L2	L4
bianco white blanc Weiß wit blanco	nebbia mist brouillard nebelgrau mist niebla	tortora turtledove tourterelle taubengrau tortelduif törtola	titanio titanium titane Titan titanium titanio



LN	LA	L6	LJ
nero black noir Schwarz zwart negro	alluminio aluminium aluminium aluminium aluminio	verde muschio moss green vert mousse moosgrün mosgroen verde musgo	giallo gold yellow gold jaune or goldgelb geelgouden loro amarillo

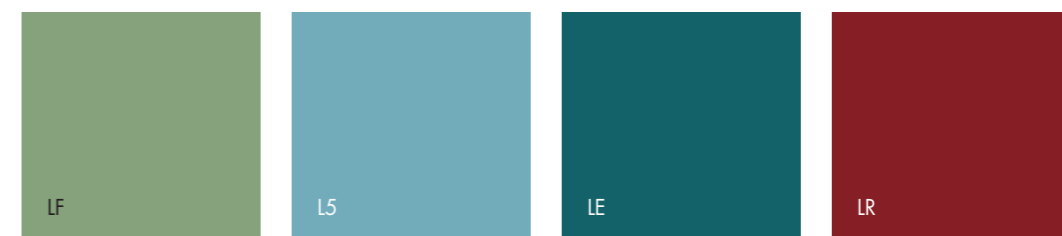

LF	L5	LE	LR
verde natura grass green vert nature grasgrün groene natuur verde naturaleza	oceano ocean océan Meerblau ocean océano	deep teal deep teal deep teal Deep Teal deep teal deep teal	bordeaux bordeaux bordeaux bordeaux bordeaux burdeos

domomag

design_Fornaciari & Fait

system

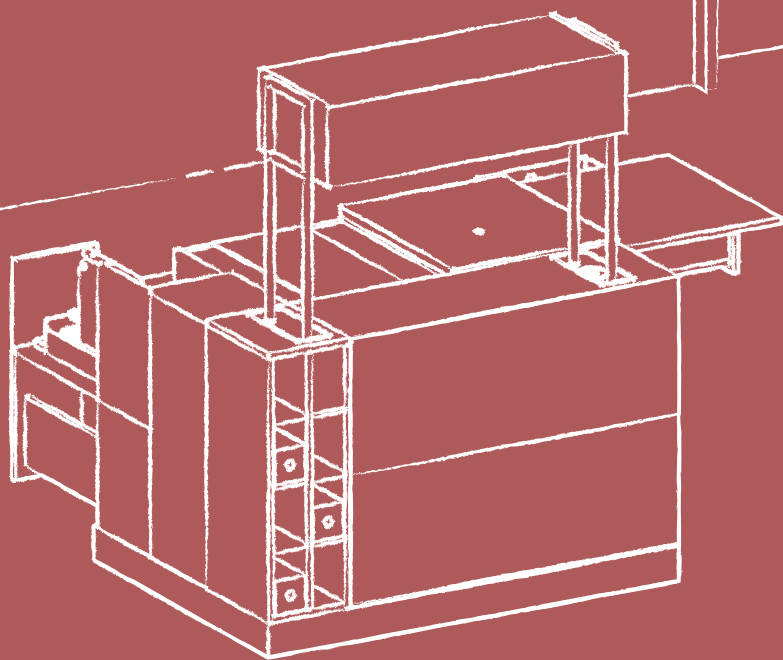
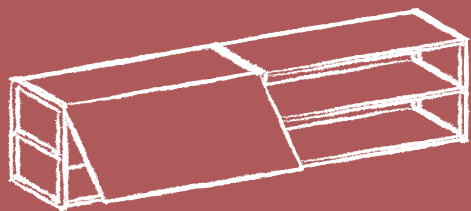

I VALORI DI DOMOMAG - The Domomag Values - Les Valeurs De Domomag - Die Werte Von Domomag - De Domomag Waarden - Los Valores De Domomag



COMPLETA
COMPLETE - COMPLÈTE
VOLLSTÄNDIG - COMPLEET
COMPLETA



CONFIGURABLE
CONFIGURABLE - CONFIGURABLE
KONFIGURIERBAR - CONFIGUREERBAAR
CONFIGURABLE

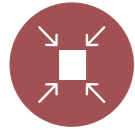

COMPATTA
COMPACT - COMPACTE
KOMPAKT - COMPACT
COMPACTA



MOBILE E RIPOSIZIONABILE
MOBILE AND REPOSITIONABLE
DEPLAÇABLE ET RECONFIGURABLE
MOBIL UND REPOSITIONIERBAR
MOBIEL EN HER-POSITIONEERBAAR
MOVIBLE Y RECOLOCABLE



COMPLETAMENTE ELETRIFICATA
COMPLETE WITH ELECTRIFICATION
ENTIÈREMENT ÉLECTRIFIÉE
VOLLSTÄNDIG ELEKTRIFIZIERT
VOLLEDIG GEËLEKTRIFICIERT
COMPLETAMENTE ELECTRIFICADA

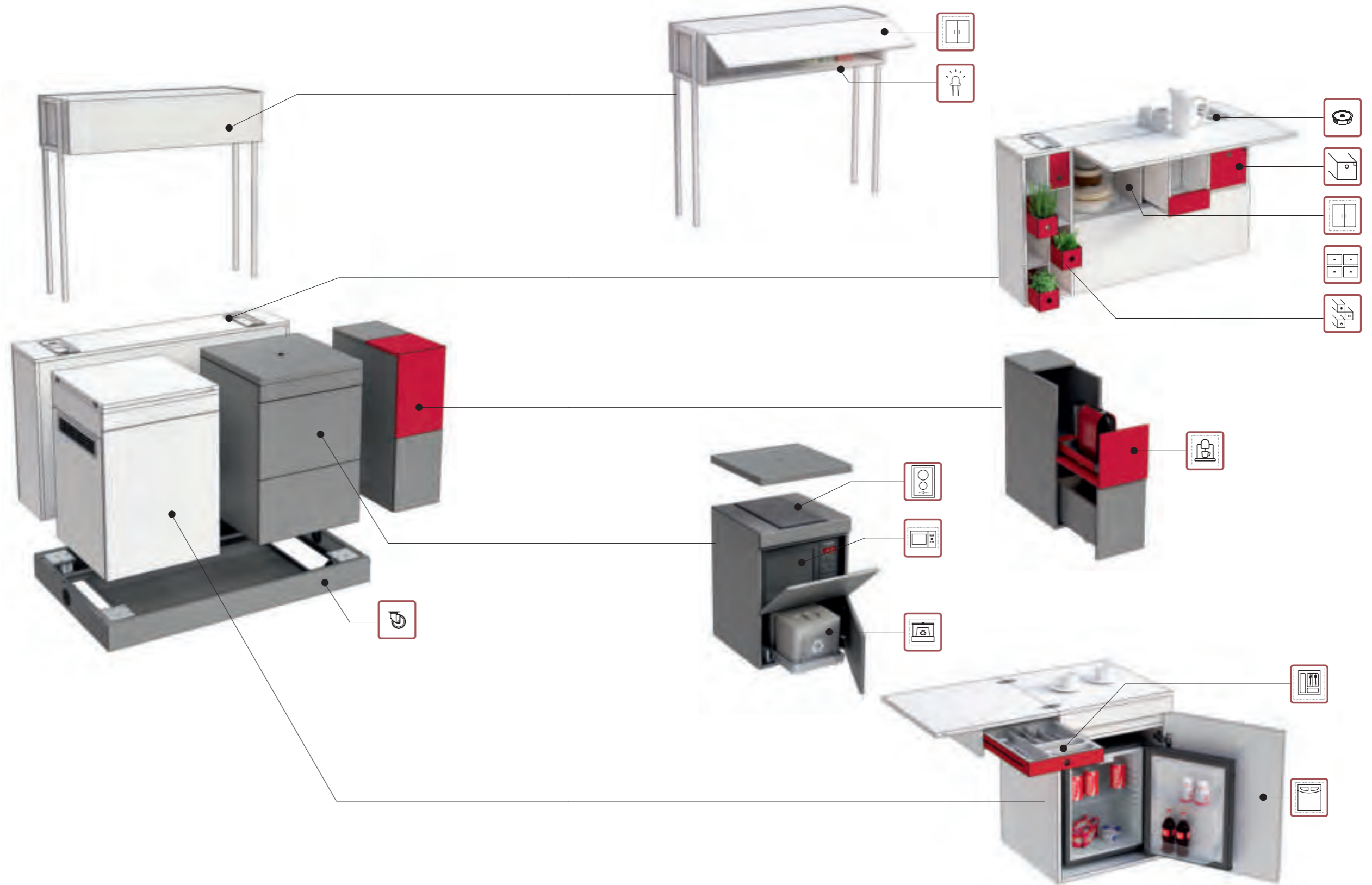

Composizioni Domomag, su ruote - Compositions on castors - Compositions sur roulettes - Kompositionen auf Rollen - Verrijdbare compositie - Composiciones sobre ruedas

DU.0805.2A

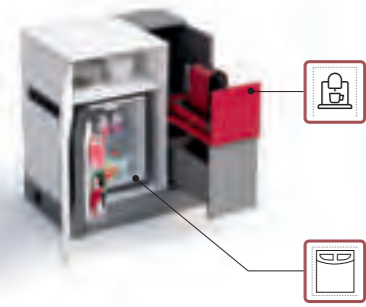

DU.0805.2B

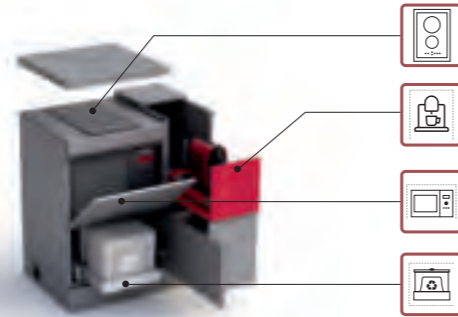

DU.1305.3A

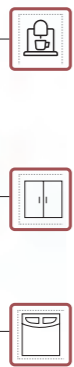
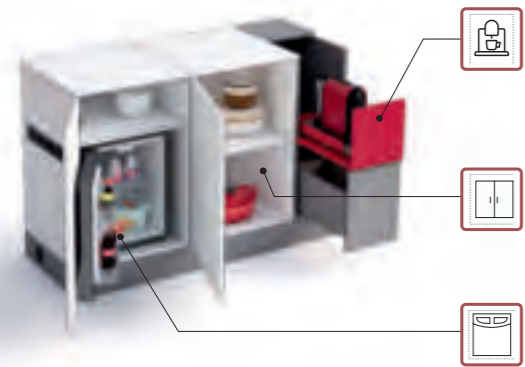



DU.1305.3B



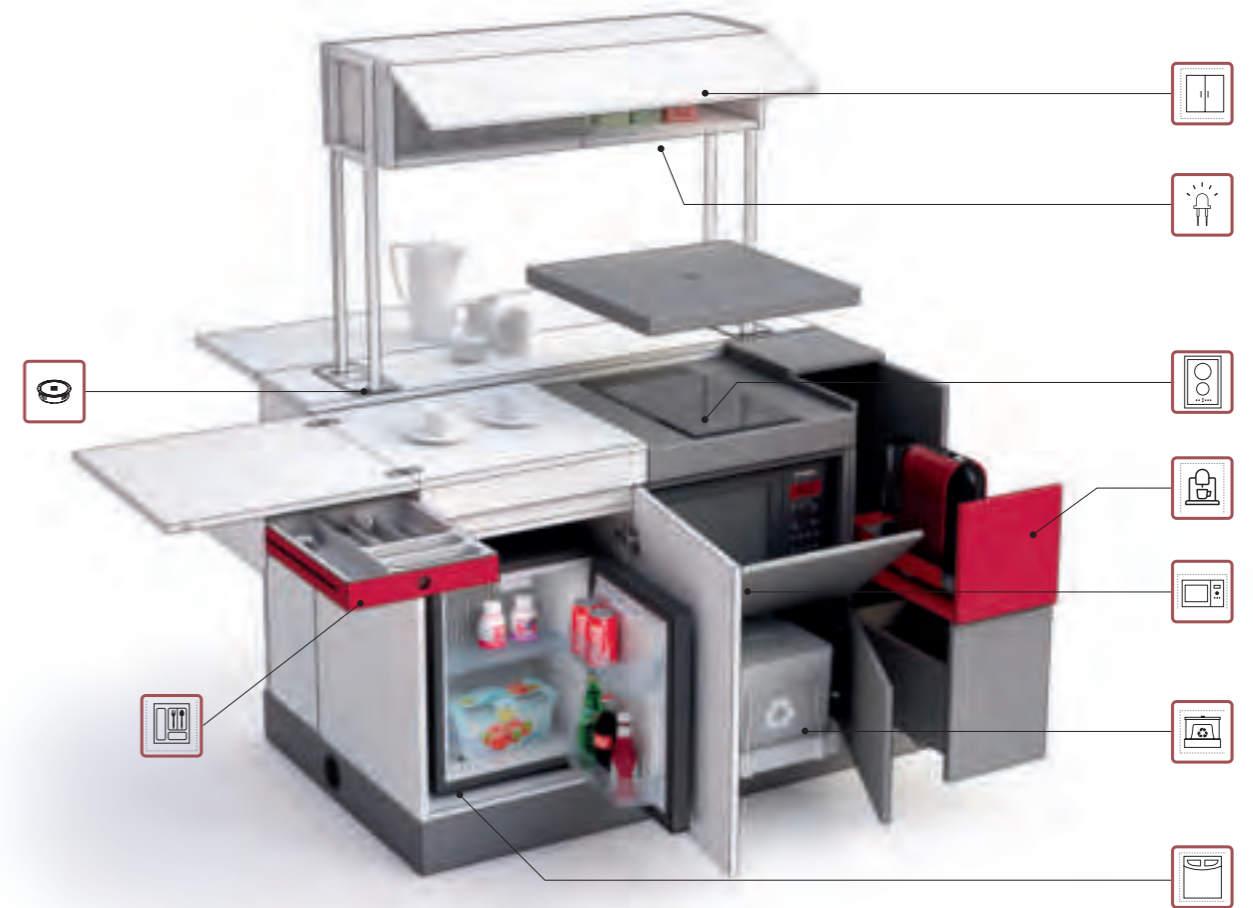

DU.1308.5A





 **Vano predisposto per macchinetta caffè**
Compartment To accommodate a coffee machine
Niche avec predisposition pour machine à café
Kaffeemaschinentfach
Compartment voor plaatsing koffiemachine
Hueco predispueto para maquina de café

 **Vano predisposto per piano cottura**
Compartment to accommodate installation of an electric Hob
Niche avec predisposition pour plaque de cuisson
Platte mit Aufnahme für Kochfelder
Compartment voor plaatsing kookplaat
Orificio predispueto para placa de cocción

 **2 contenitori porta rifiuti compresi**
Two waste pipes included
2 rangements pour déchets inclus
2 Abfallbehälter inklusive
2 afvalbakken inbegrepen
2 recipientes para residuos incluidos

 **Vano predisposto per frigo**
Compartment To accommodate a refrigerator
Niche avec predisposition pour frigo
Kühlschrank-Einbaufach
Compartment voor plaatsing koelkast
Cavidad predispueto para frigorífico

 **Vano predisposto per microonde**
Compartment to accommodate a Microwave
Niche avec predisposition pour four à micro-ondes
Mikrowellen-Einbaufach
Compartment voor plaatsing magnetron
Abertura para horno de microondas

 **Cassetto portaposate compreso**
Drawer For cutlery included
Tiroir pour couverts inclus
Besteckensatz inklusive
Besteklade inbegrepen
Cajón portacubiertos incluido

 **Vano per dispensa**
Pantry Compartment
Niche pour garde-manger
Vorrätfach
Pantry compartment
Cavidad para dispensa

 **3 cassetini porta spezie compresi**
3 holding spices drawers included
3 tiroirs porte épices inclus
Inklusive 3 Mini-Schübe
3 kleine kruidenladen inbegrepen
3 cajones porta especias incluidos

 **Optional: Versacharger**
Optional: wireless charger
Option: chargeur sans fil
Optional: Wireless-ladegerät
Optioneel: draadloze lader
Optional: Versacharger (cargador wireless)

 **Ruote**
Castors
Roulettes
Laufrollen
Wielen
Ruedas

 **Led compreso**
Led light included
Led inclus
Inklusive LED-Beleuchtung
LED licht inbegrepen
Led incluido

 **Vano tecnico ispezionabile**
Inspectionable technical compartment
Niche technique inspectionnable
Inspezierbares Kabellfach
Inspekteerbaar technisch element
Vano tecnico inspeccionable

 **4 mini contenitori**
4 small compartments
4 petits rangements
4 kleine Leerablagefächer
4 smalle elementen
4 mini contenedores

MODULI COMPONENTI, SU PIEDINI - Modular storage, on feet - Modules intégrés avec pieds
Einbaumodule, auf Rollen - Modulair opbergstelsysteem, op voetjes - Modulos componibles, sobre patas



Vano predisposto per macchinetta caffè
Compartment To accommodate a coffee machine
Niche avec predisposition pour machine à café
Kaffeemaschinentach
Compartment voor plaatsing koffiemachine
Hueco predispuesto para maquina de café



Vano predisposto per piano cottura
Compartment to accommodate installation of an electric Hob
Niche avec predisposition pour plaque de cuisson
Platte mit Aufnahme für Kochfelder
Compartment voor plaatsing kookplaat
Orificio predispuesto para placa de cocción



2 contenitori porta rifiuti compresi
Two waste pipes included
2 rangements pour déchets inclus
2 Abfallbehälter inklusive
2 afvalbakken inbegrepen
2 recipientes para residuos incluidos



Vano predisposto per frigo
Compartment To accommodate a refrigerator
Niche avec predisposition pour frigo
Kühlschrank-Einbaufach
Compartment voor plaatsing koelkast
Cavidad predispuesta para frigorífico



Vano predisposto per microonde
Compartment to accommodate a Microwave
Niche avec predisposition pour four à micro-ondes
Mikrowellen-Einbaufach
Compartment voor plaatsing magnetron
Abertura para horno de microondas



Cassetino portaposate compreso
Drawer For cutlery included
Tiroir pour couverts inclus
Besteckensatz inklusive
Besteklade inbegrepen
Cajón portacubiertos incluido



Vano per dispensa
Pantry Compartment
Niche pour garde-manger
Vorrätetach
Pantry compartment
Cavidad para dispensa



Fondo salvagoccia compreso
Water plate protection included
Plaque de protection projections d'eau
Inklusive Nässechutzverkleidung aus Metall
Spatwater plaat inbegrepen
Fondo salvagata incluido



3 cassetini porta spezie compresi
3 holding spices drawers included
3 tiroirs porte épices inclus
Inklusive 3 Mini-Schübe
3 kleine kruidenladen inbegrepen
3 cajones porta especias incluidos



Pensile con possibilità di inserimento scolapiatti
Wall unit with optional dish rack
Meuble suspendu avec égouttoir optionnel
Hängeschrank mit Einbaumöglichkeit eines Abtropfgitters
Wand met optioneel borderek
Pénsil con posibilidad de inserción de escurrer platos



Lavello + sifone + miscelatore monocomando compresi
Sink Complete with Plughole and water taps included
Evier+siphon+mitigeur inclus
Inklusive Spülbecken mit Siphon und Einhebelmischbatterie
Wasbak compleet met kraan en afvoer inbegrepen
Fregadero + sifón + mezclador monomando incluidos



4 mini contenitori
4 small compartments
4 petits rangements
4 kleine Leerablagefächer
4 smalle elementen
4 mini contenedores

DU.1305.3B



DU.1305.3B



DU.1308.5A



DU.1308.5A



DK.2405.C3 - DF.2017.SC

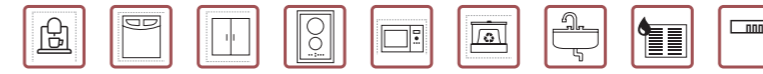



Composizioni su ruote - Compositions on castors - Compositions sur roulettes - Kompositionen auf Rollen - Vrijrijdbare compositie - Composiciones sobre ruedas

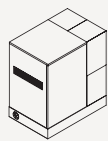

81 x 54 H.92 cm
31¾" x 21¼" H.36¼"

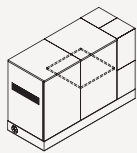
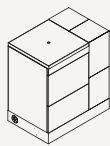

135 x 54 H.92 cm
53" x 21¼" H.36¼"

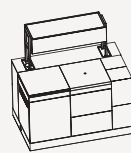
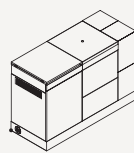

135 x 83,5 H.170 cm
53" x 32¾" H.67"

Moduli componibili, su piedini - Modular storage, on feet - Modules intégrés avec pieds - Einbaumodule, auf Rollen - Modulair opbergsysteem, op voeltes - Modulos componibles, sobre patas

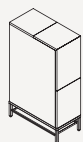

27 x 54 H.92 cm
10¾" x 21¼" H.36¼"



54 x 54 H.92 cm
21¼" x 21¼" H.36¼"

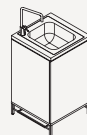
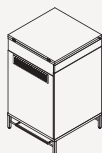

54 x 54 H.106 cm
21¼" x 21¼" H.41¾"

Scaffale e pensili - Shelf and wall unit - Étagère et meuble suspendu - Regal und Wandmodul - Plank met opknoping - Estantería y armario de pared

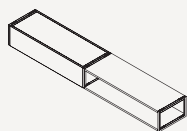

202 x 36 H.23 cm
79½" x 14" H.9"

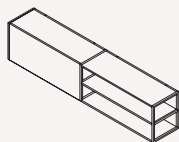

202 x 36 H.44 cm
79½" x 14" H.17¼"





202 x 36 H.170 cm
79½" x 14" H.67"

Painture - Finishes - Finitions - Oberflächen - Afwerkingen - Acabados

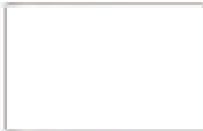

Melaminico - Laminate - Melamina - Melamin - Melamine - Melaminos

GS	RD	BL
		
<p>Grigio granito Grante grey Grís granit Granitgrau Granitgrün Grís granito</p>	<p>Rouge rubine Ruby red Rouge rubis Rubinea Rubinrot Rojo rubí</p>	<p>Bianco White Blanc Weiß Weiß Blanco</p>

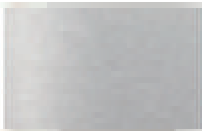
Parti metallique - Metal structure - Structure metallique - Metallstruktur - Stalen constructie - Estructura metallica

GF	BW	KR	RF	AX
				
<p>Grigio granito Grante grey Grís granit Granitgrau Granitgrün Grís granito</p>	<p>Bianco White Blanc Weiß Weiß Blanco</p>	<p>Chrom lucido Shiny Chrome Chrom brillant Chrom glänzend Chromverchromt Cromo Brillo</p>	<p>Rouge rubine Ruby red Rouge rubis Rubinea Rubinrot Rojo rubí</p>	<p>Acabado mate Glossless mat Afini mat Matt Mat Acabado mate</p>

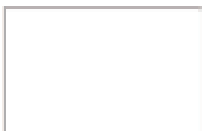
Plastic - Plástico - Plastique - Plastik - Plastic - Plástico

BP	NE
	
<p>Acabado color blanco White color plastic finish Détails en blanc Detalls blancs Details in white Detalles de color blanco</p>	<p>Acabado color negro Black color plastic finish Détails en noir Detalls negres Details in black Detalles de color negro</p>

vivax IRODABÚTOR

4026 Debrecen, Hunyadi utca 8.
Tel. +36 52 524 540
Fax. +36 52 524 541
Mobil. +36 30 336 0699
Email. vivax@vivax.hu, tervezes@vivax.hu
www.vivax.hu

2045 Törökbálint, Tópark utca 1/a.
(MaxCity Lakberendezési Áruház, II. em. 232. ID Design)
Tel. +36 23 444 707
Fax. +36 23 444 708
Mobil. +36 30 968 5232
Email. budapest@vivax.hu

3525 Miskolc, Széchenyi utca 7.
(Pátria Üzletház 1.emelet)
Tel. +36 46 413 920
Fax. +36 46 413 921
Mobil. +36 30 903 9255
Email. vivaxmiskolc@vivax.hu



www.facebook.com/vivaxiroda