

NARDI
YOUR OUTDOOR LIVING

vivax

outdoor
design Raffaello Galotto

Il design. Il relax all'aria aperta.
La voglia di stare insieme e di godere del tempo libero.
Da 30 anni Nardi è specializzata nella progettazione e realizzazione
di arredi in polipropilene per l'esterno di qualità e di design
sia per il settore residenziale che per l'hospitality.
Ogni prodotto è studiato per il benessere e il relax delle persone,
ottenuto in una filiera totalmente Made in Italy
e nel rispetto dell'ambiente.

*Design Relaxing outdoors.
The desire to be together and enjoy your leisure time.
For 30 years, Nardi has specialised in designing and producing
high-quality designer furniture in polypropylene for outdoor use
in the residential and hospitality sectors.
All its products, designed for people's wellbeing and relaxation,
are made in a production chain that is entirely "Made in Italy"
and eco-friendly.*

visione vision

Cultura del progetto open air, attitudine al design innovativo, attenzione verso le persone e impegno ambientale. Nardi promuove l'incontro tra un disegno originale e la tecnologia più all'avanguardia, l'alta qualità unita al well-being e al pensiero ecologico che si concretizza nella totale riciclabilità dei suoi prodotti e nel programma industriale Regeneration per il recupero e la rigenerazione della plastica obsoleta.

Outdoor design culture, an inclination for innovative design, a focus on people and environmental commitment. Nardi promotes the fusion of original design with cutting-edge technology, high quality combined with well-being and an eco-friendly approach that translates into the total recyclability of its products and the Regeneration industrial project for the recovery and regeneration of obsolete plastic.

prodotti products

Il polipropilene, lavorato con tecnologie di ultima generazione, è proposto in abbinamento con alluminio, vetro, tessuto sintetico e imbottiti per realizzare arredi dal disegno originale, pensati per stare all'esterno in qualsiasi stagione e condizione meteo, facilmente sanificabili e totalmente riciclabili. Fabbricate completamente in Italia e sottoposte a severi test qualitativi, le collezioni Nardi durano a lungo e, negli ultimi anni, hanno ricevuto numerosi riconoscimenti internazionali per design e sostenibilità ambientale.

Polypropylene, processed using the latest generation technology, is proposed in combination with aluminium, glass, synthetic fabrics and padded elements to create furniture with original design. This furniture is designed to be left outdoors in any season and weather conditions, is easily sanitized and completely recyclable. Made entirely in Italy and submitted to stringent quality tests, Nardi collections have a long life. In recent years, they have received many international awards for design and environmental sustainability.

index

10	<i>folio my special place</i>
36	<i>komodo modular system</i>
64	rio • trill • net
84	net collection
94	aria
102	alloro • palma
112	loto • ninfea
120	atlantico • pop
128	cube • erica
133	<i>schede tecniche/technical details</i>

Folio

my special place

Il morbido e piacevole abbraccio di una poltrona davvero speciale.

Folio è un'innovativa poltrona relax proposta a basa fissa o nella romantica versione a dondolo, reclinabile in due posizioni e completata dal poggiatesta/sgabello Poggio.

Uno stile curato nei dettagli, delineato dall'unione di linee pure, colori e imbottiti per incantevoli angoli di relax.

The soft and pleasant embrace of a very special armchair.

Folio is an innovative relaxing armchair available with a fixed base or in a romantic rocking version. It reclines to two positions and can be complemented with the Poggio footrest/stool.

Its style features meticulous details, highlighted by a combination of elegant lines, colours and padded elements that allow charming corners of relaxation to be created.





FOLIO ROCKING tabacco / felce
FOLIO tabacco / felce



FOLIO ROCKING tabacco / felce





FOLIO tabacco
POGGIO tabacco



FOLIO tabacco / felce
POGGIO tabacco



FOLIO tabacco



FOLIO antracite



FOLIO antracite / rosa quarzo
POGGIO antracite



FOLIO antracite / rosa quarzo



FOLIO antracite / rosa quarzo
POGGIO antracite
SPRITZ antracite



FOLIO agave / artic
POGGIO agave
SPRITZ agave





FOLIO agave / artic





POGGIO agave



FOLIO bianco / lino
FOLIO ROCKING bianco / lino
POGGIO bianco



Komodo *modular system*

Sistema di sedute imbottite modulari, componibili e configurabili a piacere. La struttura, ispirata ai rami degli alberi, connota l'arredo con carattere e accoglie soffici e colorati cuscini per creare la propria stanza a cielo aperto.

A modular upholstered seating system that can be arranged and configured as required. Its frame, inspired by tree branches, adds character to the furniture with soft colourful cushions to create your own open-air room.



GOOD DESIGN
AWARD 2019
winner





KOMODO agave / avocado - giungla
KOMODO TAVOLINO agave



KOMODO POLTRONA agave / giungla



KOMODO POLTRONA agave / avocado



KOMODO agave / avocado - giungla
KOMODO TAVOLINO agave





KOMODO bianco / canvas
KOMODO TAVOLINO VETRO bianco / vetro



KOMODO bianco / canvas
KOMODO TAVOLINO VETRO bianco / vetro

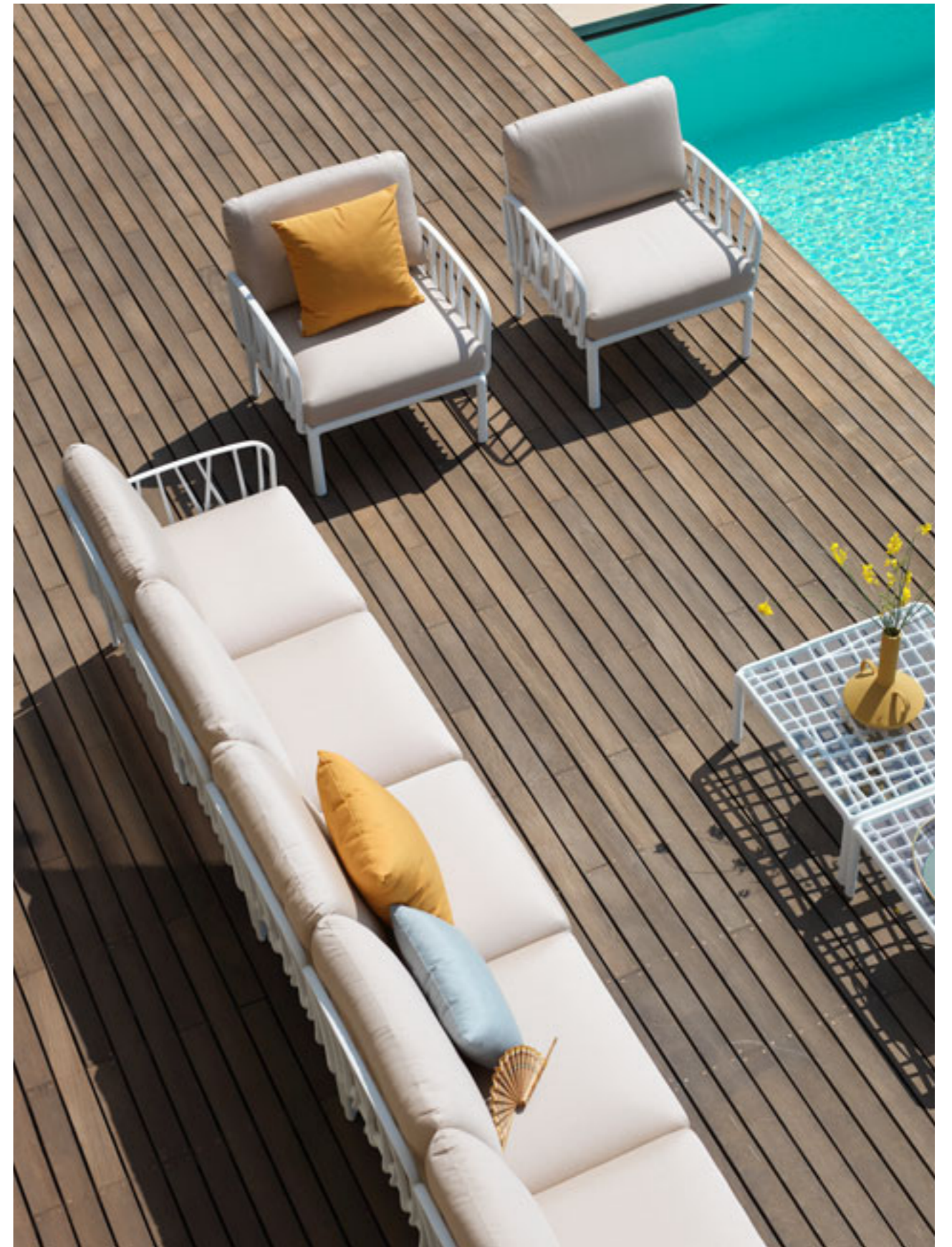

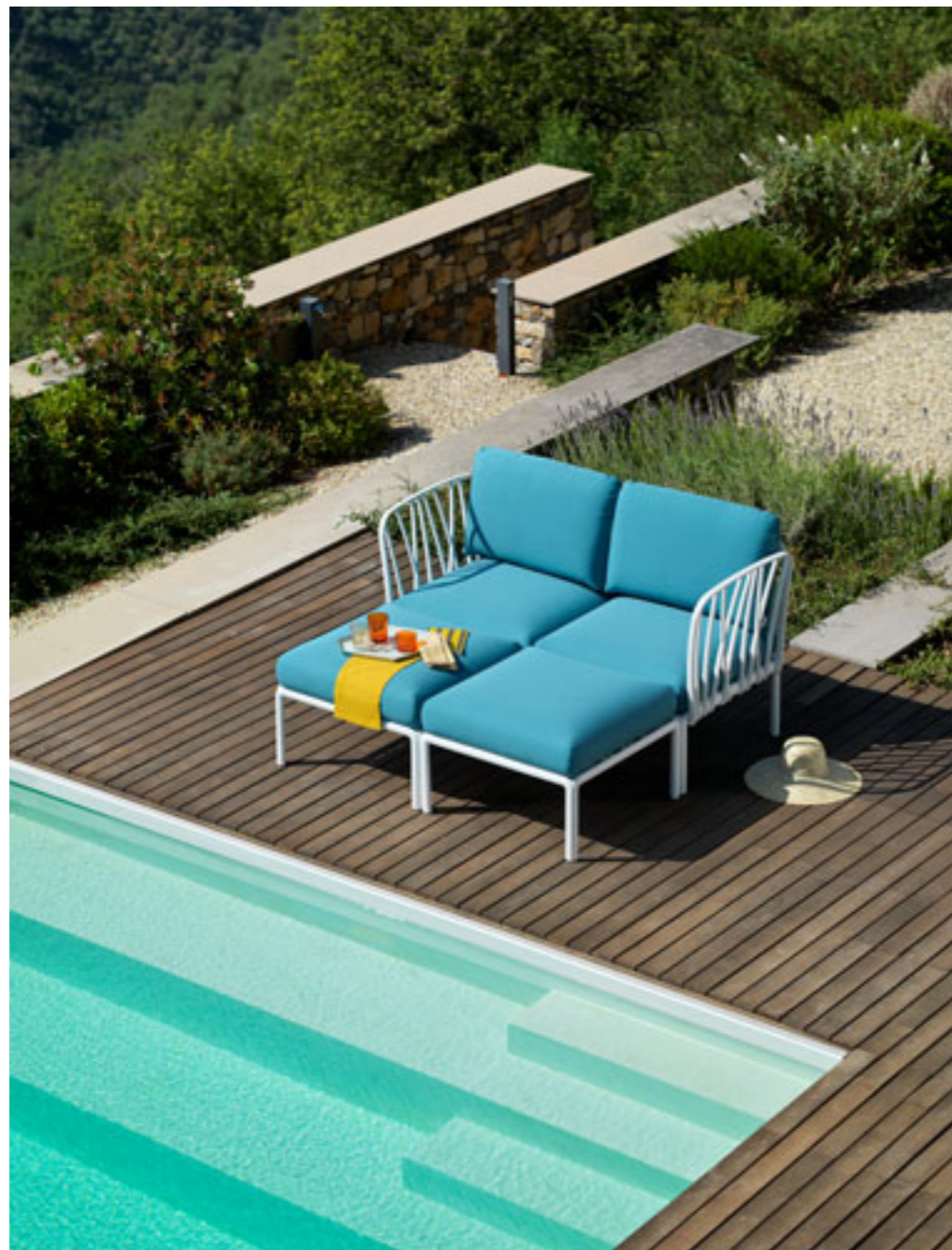

KOMODO bianco / adriatic





KOMODO TAVOLINO VETRO antracite / vetro



KOMODO antracite / rosa quarzo



KOMODO antracite / rosa quarzo
KOMODO TAVOLINO VETRO antracite / vetro

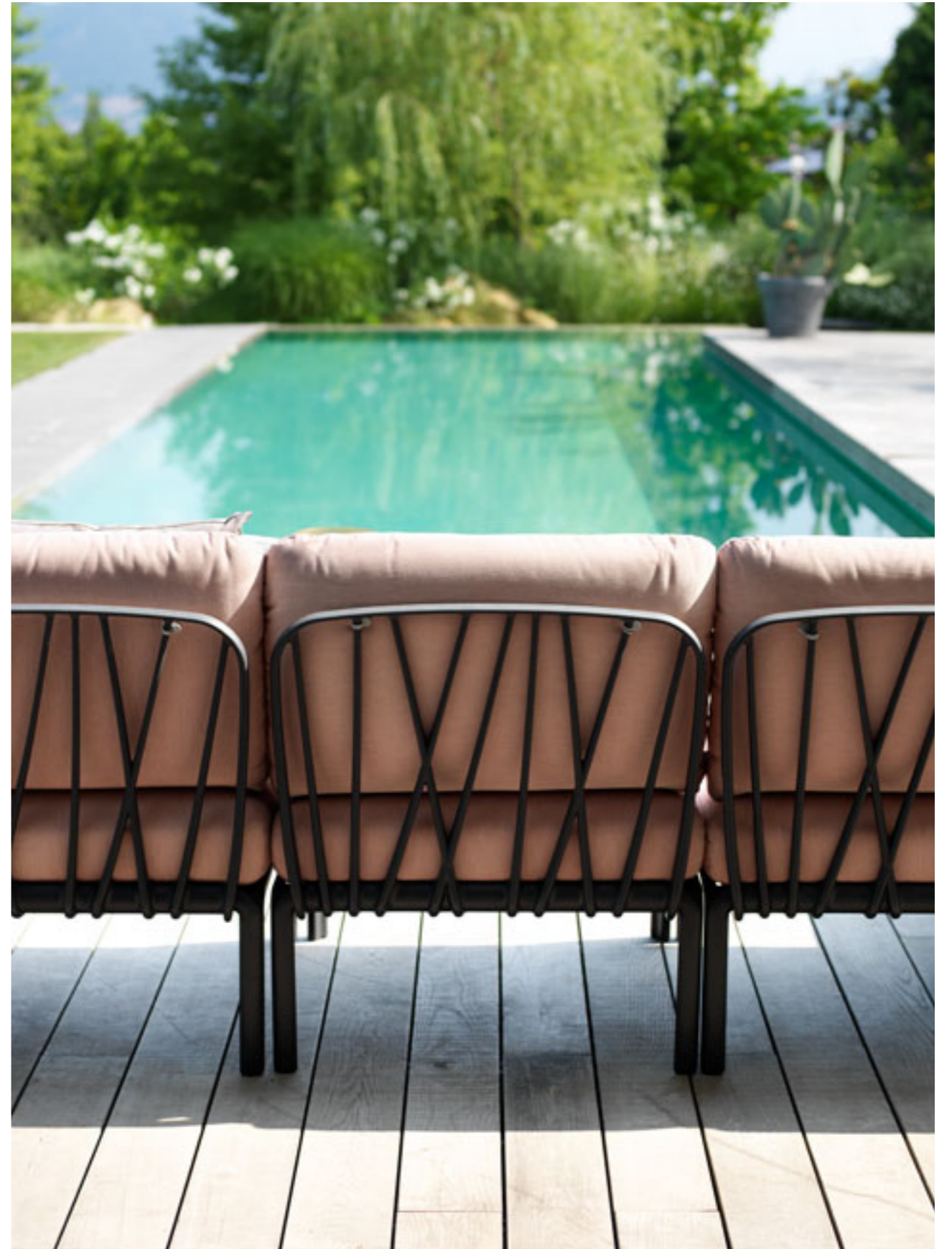



KOMODO antracite / rosa quarzo

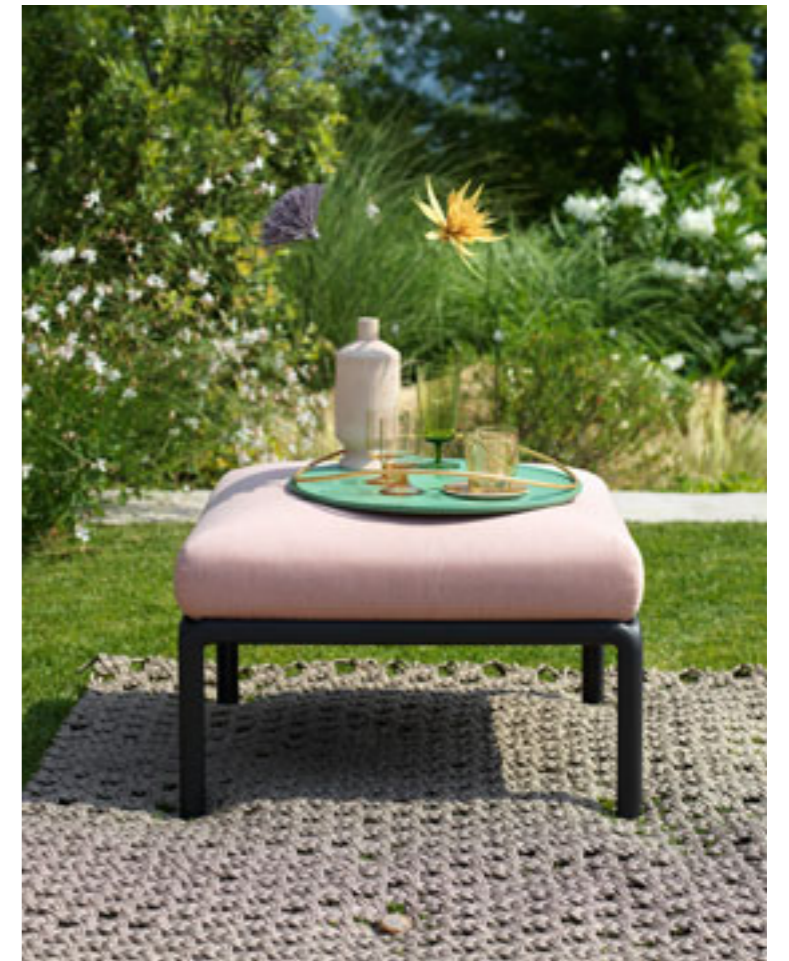

KOMODO POUF antracite / rosa quarzo

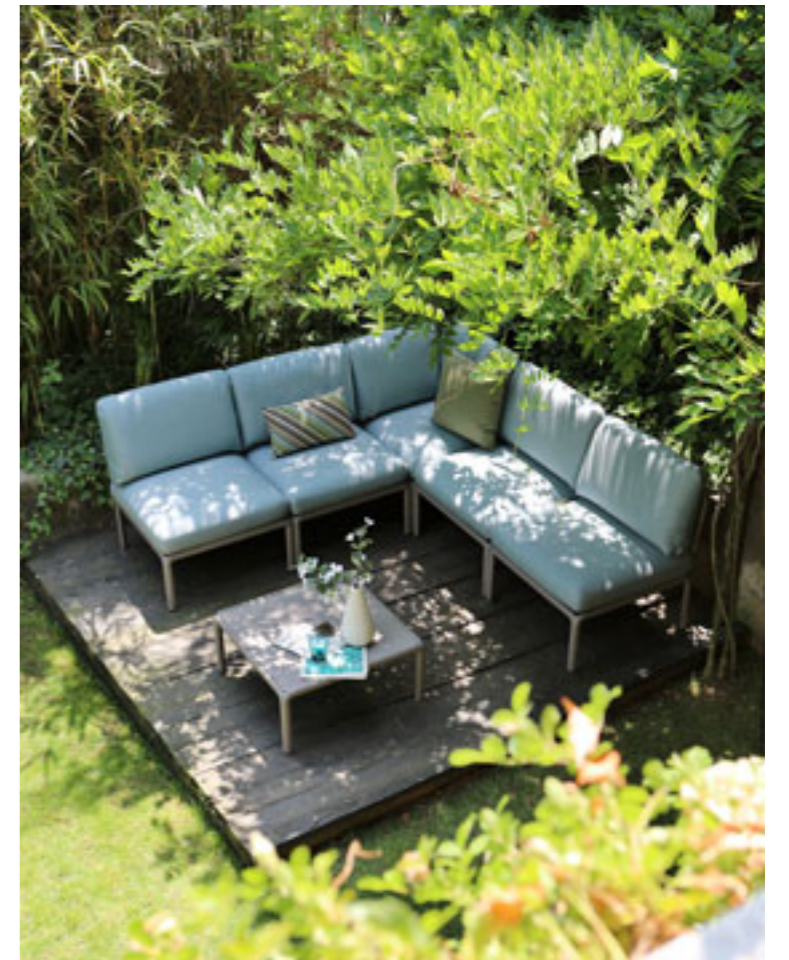

KOMODO 5 tortora / ghiaccio
KOMODO TAVOLINO tortora



KOMODO 5 tortora / ghiaccio





KOMODO POLTRONA bianco / grigio
KOMODO TAVOLINO VETRO bianco / vetro





KOMODO POLTRONA bianco / grigio
KOMODO TAVOLINO VETRO bianco / vetro



KOMODO TAVOLINO VETRO bianco / vetro

Rio • Trill • Net

Chiacchierare, ridere, raccontare, trovare sempre un posto per chi arriva all'improvviso. Tavoli allungabili dalla movimentazione facile e invisibile, sedute di diverse forme, colori e gradi di comfort che permettono di creare scenografie outdoor su misura.

Chatting, laughing and telling stories, always finding a place for those who turn up unexpectedly. Tables that extend with a simple concealed movement and chairs in various shapes, colours and levels of comfort that allow you to create customised outdoor settings.





RIO ALU 210 EXTENSIBLE antracite
TRILL ARMCHAIR agave



RIO ALU 210 EXTENSIBILE antracite



TRILL BISTROT ottanio



TRILL ARMCHAIR rosa bouquet



RIO ALU 210 EXTENSIBLE antracite
NET senape



NET senape



RIO ALU 210 EXTENSIBILE antracite
NET senape



RIO ALU 210 EXTENSIBLE antracite
NET senape



RIO ALU 210 EXTENSIBLE antracite



RIO 210 EXTENSIBLE tortora
NET RELAX tortora / rosa quarzo



RIO 210 EXTENSIBLE tortora
NET RELAX tortora / rosa quarzo



NET RELAX tortora
CUSCINO NET RELAX rosa quarzo
CUSCINO SHELL rosa quarzo



RIO 140 EXTENSIBLE bianco
BIT bianco



BIT salice

Net collection

Raffinato relax, interpretato da armoniche palette di colori che si compongono e contrappongono in un gioco di elementi - poltroncine, divanetti, tavolini e cuscini - che dialogano tra loro per personali look open air.

Refined relaxation is expressed with harmonious colour palettes that are combined and contrasted in an interplay of elements - armchairs, sofas, side tables and cushions - that come together for a personal open-air look.

NET RELAX awards



GOOD DESIGN
AWARD 2018
winner



reddot award 2018
winner



selected by
ADI DESIGN
INDEX 2017





NET BENCH salice / sardinia
NET RELAX salice / sardinia
NET TABLE 100 salice



NET RELAX salice / sardinia



NET TABLE 100 salice



NET BENCH bianco / grigio
NET RELAX bianco / grigio
NET TABLE 100 bianco



NET BENCH senape / denim
CUSCINO PASSEPARTOUT denim



NET BENCH senape / denim
NET RELAX senape / denim
NET TABLE 100 senape

Aria

Progettare salotti all'aperto per godere delle serate in compagnia, della brezza del mare, dell'aria fresca di montagna. Le doghe, fil rouge stilistico della collezione, disegnano poltroncine e tavolini personalizzabili con una vasta scelta di cuscini di diverse forme e colori.

Creating outdoor lounges for enjoying evenings in company, with a sea breeze or fresh mountain air.

Slats, the recurring stylistic theme of the collection, give shape to armchairs and side tables that can be customised with a wide choice of cushions in various shapes and colours.





ARIA POLTRONA bianco / sardinia
ARIA TAVOLINO 100 bianco



ARIA POLTRONA tortora / lime
ARIA TAVOLINO 100 tortora



ARIA TAVOLINO 100 tortora



ARIA POLTRONA tortora / lime

Alloro • Palma

Versatilità e facilità d'utilizzo sono le connotazioni dei tavoli allungabili Nardi che vantano alte prestazioni e disegnano conviviali scenari nel nome di tecnica e design. Le armoniose silhouette della struttura dei tavoli e delle sedute abbinata evocano quelle dei classici listelli di legno.

Nardi's extending tables are versatile and easy to use, offering high performance while creating convivial arrangements focused on technology and design.

The harmonious silhouettes of the table frames and matching chairs are reminiscent of classic wooden slats.





ALLORO 210 EXTENSIBLE tortora / tortora
PALMA tortora / tortora



ALLORO 210 EXTENSIBLE tortora / tortora
PALMA tortora / tortora



ALLORO 210 EXTENSIBLE tortora / tortora



ALLORO 140 EXTENSIBLE bianco / tortora
PALMA bianco / tortora



ALLORO 140 EXTENSIBLE bianco / tortora



PALMA bianco / tortora

Loto • Ninfea

Atmosfere contemporanee, create attraverso l'incontro di diversi materiali - vetro, metallo, resina - che sottolineano la qualità e la ricercatezza di una collezione che assolve alle tante esigenze del vivere gli spazi all'aperto.

Contemporary atmospheres, created by combining different materials - glass, metal, resin - that underline the quality and refinement of a collection that meets the many requirements of outdoor living.





LOTO DINNER 190 antracite / antracite
NINFEA DINNER antracite / antracite





LOTTO RELAX 95 bianco / bianco
NINFEA RELAX bianco / bianco



NINFEA RELAX bianco / bianco



LOTO RELAX 95 bianco / bianco

Atlantico • Pop

Rituali di benessere sia per gli occhi che per il corpo. Atlantico e Pop uniscono la massima ergonomia alla qualità di dettagli e materiali. Un concept estetico dalle linee pure ed essenziali in un'ampia scelta di colori.

Rituals of wellbeing for the eyes and the body.

Atlantico and Pop combine excellent ergonomics with quality details and materials. An aesthetic concept with simple elegant lines and a wide choice of colours.





ATLANTICO tortora / agave

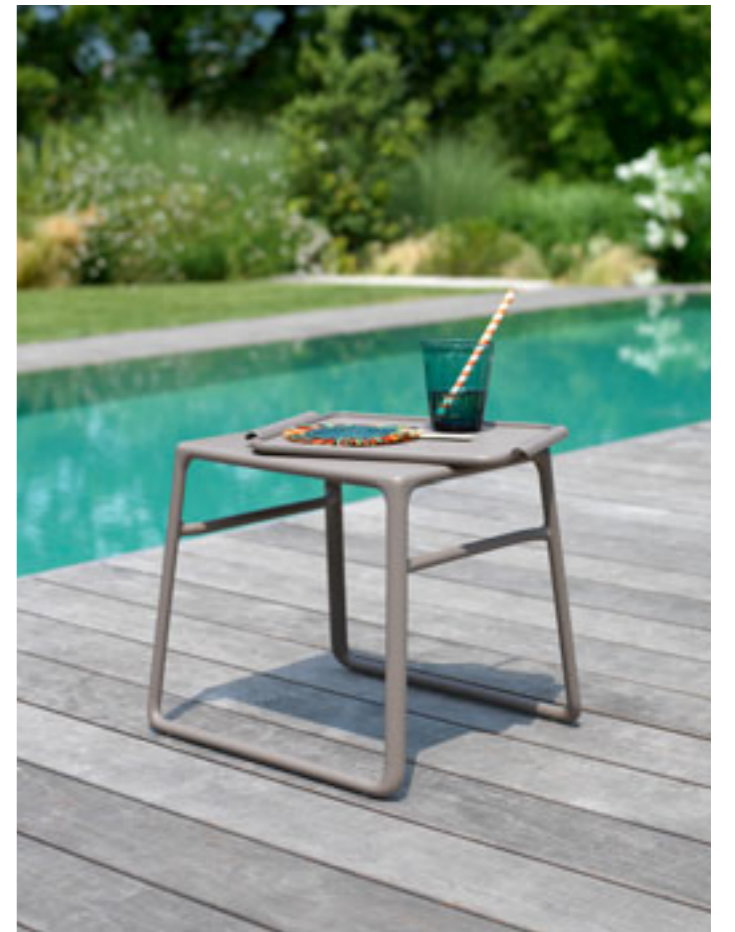

POP tortora



ATLANTICO bianco / bianco
POP bianco



ATLANTICO antracite / antracite
POP antracite

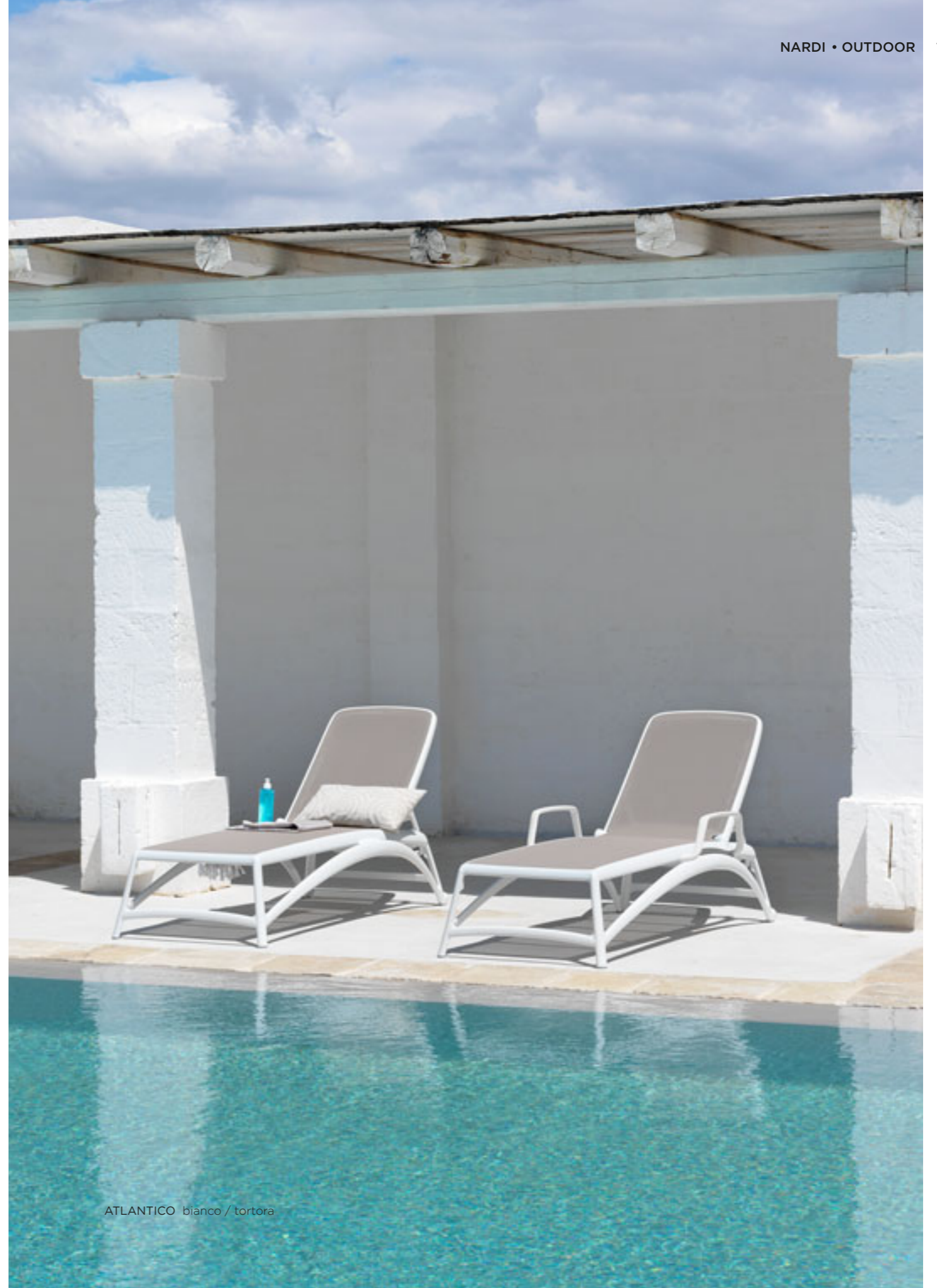

ATLANTICO bianco / tortora

Cube • Erica

Soluzioni per l'outdoor living all'insegna dei nuovi codici del vivere all'aperto che esigono versatilità e flessibilità.

Design rigoroso per una collezione di tavoli con piano squadrato, utilizzabili singolarmente o illimitatamente replicabili.

Outdoor living solutions based on new trends in open-air living that require versatility and adaptability.

A collection of tables in rigorous design with a square top. They can be used independently or endlessly aligned.





CUBE 140x80 caffè / caffè



CUBE 140x80 caffè / caffè
ERICA tortora

schede tecniche
technical details

FOLIO

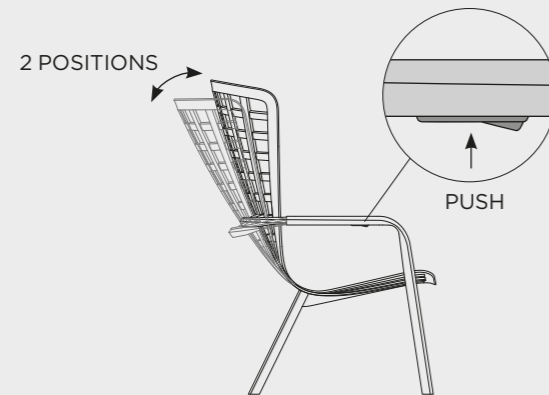

FOLIO ROCKING

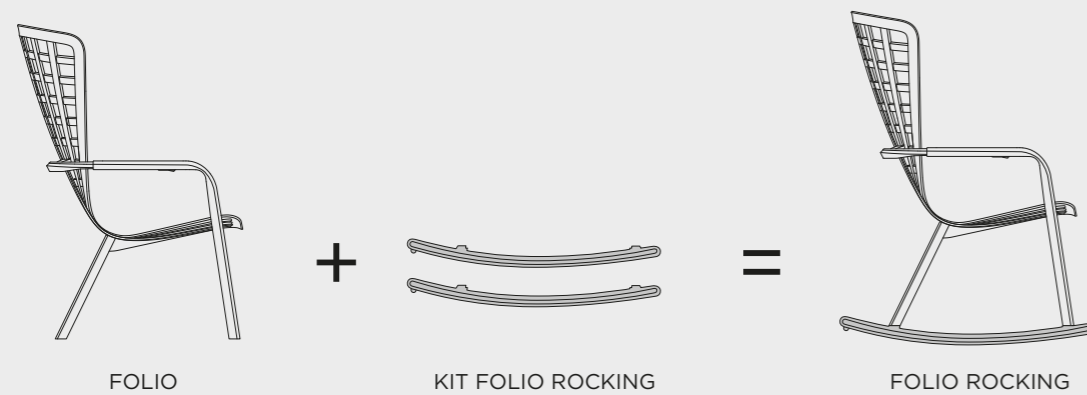

FOLIO è una innovativa poltrona relax a due posizioni pensata per l'outdoor, proposta su base fissa, con poggiatesta, oppure nella romantica versione a dondolo.

L'ampia scocca della poltrona è costituita da un unico foglio dal design sapientemente curvato in modo da permettere il movimento tra seduta e schienale sfruttando l'elasticità del materiale senza l'ausilio di elementi di congiunzione o di rotazione.

FOLIO is an innovative relaxing armchair, adjusting to two positions, designed for outdoor use.

It is available with a fixed base and a footrest, or in a romantic rocking version.

The large structure of the armchair is made from a single perforated sheet. It has an expertly curved design that allows movement between the seat and back, exploiting the flexibility of the material without requiring any linking or rotating elements.

FOLIO **new**

polipropilene fiberglass

KIT FOLIO ROCKING **new**

polipropilene fiberglass

POGGIO **new**

polipropilene fiberglass

CUSCINO FOLIO COMFORT **new**

tessuto



Variazioni di colore sono da ritenersi standard e naturali nei tessuti acrilici tinto filo. Posizionare in zone d'ombra - Colour variations are to be considered standard and natural in yarn-dyed acrylic fabrics. Position in shaded areas - Les variations de couleur des tissus acryliques au fil teint sont standard et naturelles. Placer dans des zones ombragées - Farbveränderungen sind als Standard und in im Garn gefärbten Acrylgeweben als natürlich zu betrachten. In schattigen Bereichen aufstellen - Las variaciones de color son normales y naturales en las telas acrílicas teñidas en hilo. Colocar en zonas de sombra - As variações de cor são consideradas standard e naturais nos tecidos acrílico tingidos com fio. Posicionar em zonas de sombra - Boyalı akrilik iplik kumaşlarda renk değişiklikleri standart ve doğal kabul edilir. Gölgeli alanlara yerleştiriniz - Изменения цвета следует считать нормой, они являются естественными в случае акриловых тканей с окрашенными волокнами. Размещать в тени.

KOMODO

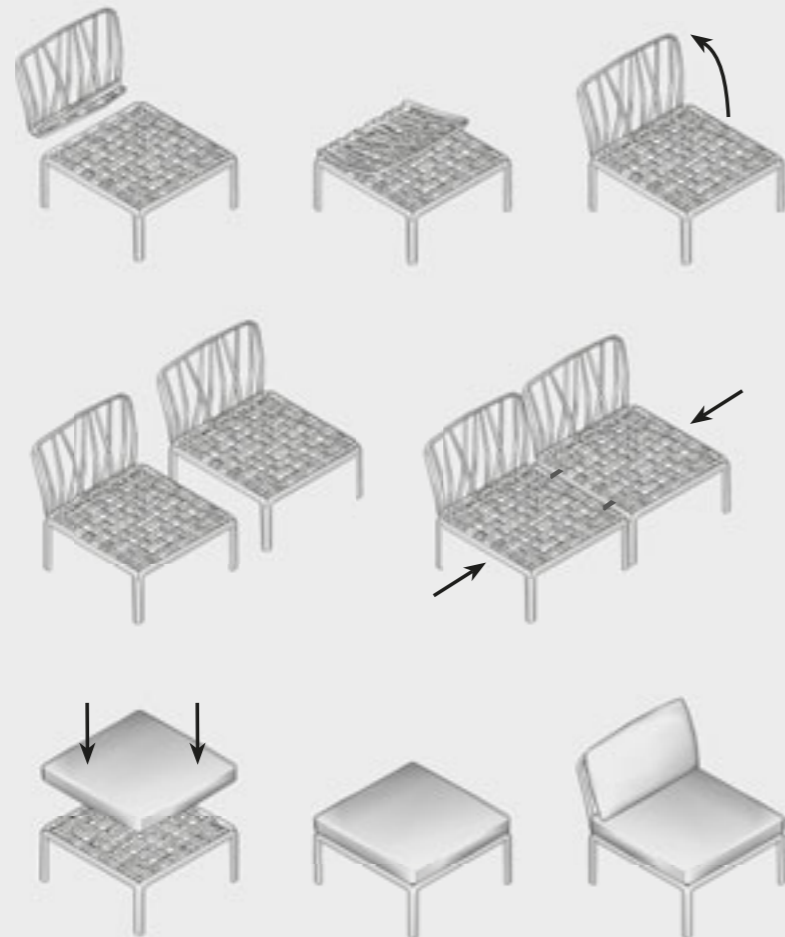

KOMODO è un sistema modulare di sedute configurabile a piacere. I moduli possono essere fissati tra loro e gli schienali e i braccioli sono agganciabili su tutti i lati della seduta.

Oltre alla versione standard KOMODO 5, è possibile configurare e ordinare la tua versione personalizzata elencando tutti i singoli elementi che la formano.

KOMODO is a modular system of upholstered seats which can be configured to suit your particular needs. The modules can be secured to one another and the backrests and armrests can be attached on all sides of the seat.

In addition to the standard KOMODO 5 version, you can configure and order your own customized version simply by listing all the individual elements you require.

KOMODO POLTRONA

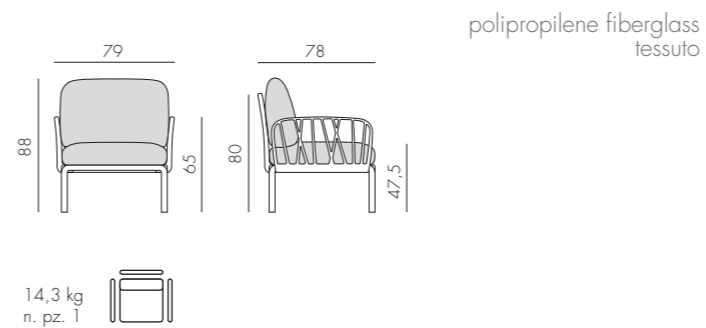

KOMODO ELEMENTO TERMINALE DX/SX

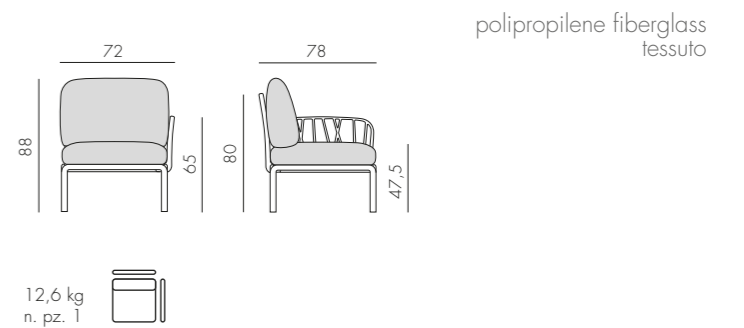

KOMODO ELEMENTO CENTRALE

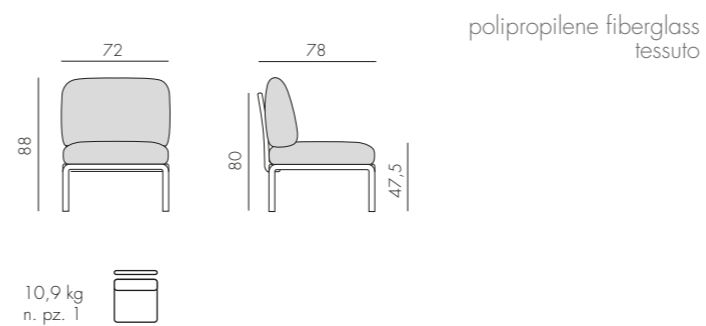

KOMODO ELEMENTO ANGOLO

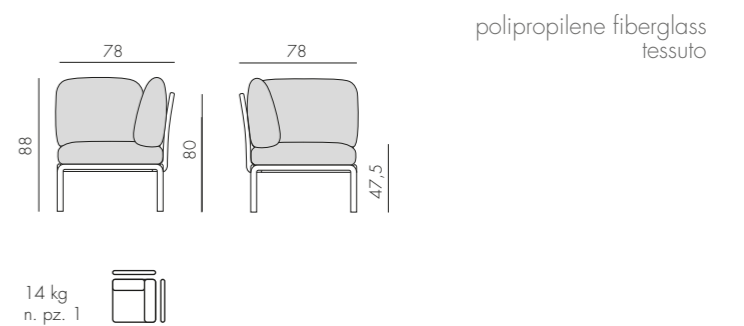

KOMODO POUF



KOMODO 5

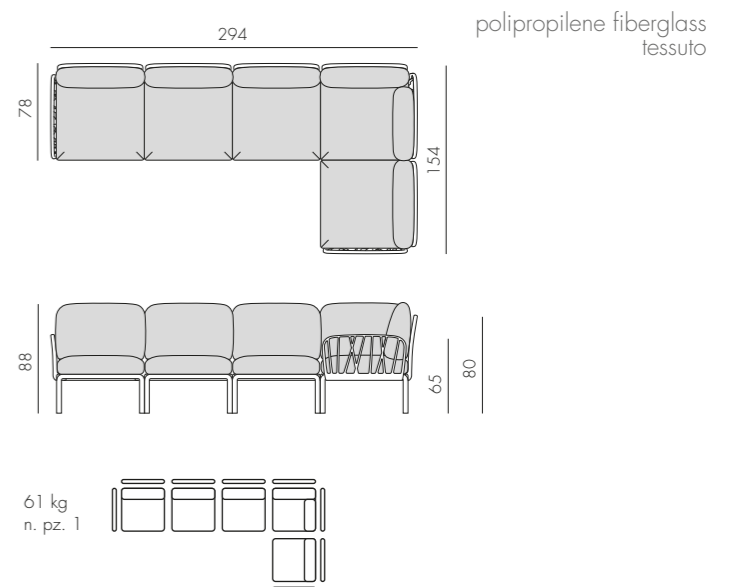



	POLTRONA	ELEMENTO TERMINALE DX/SX	ELEMENTO CENTRALE	ELEMENTO ANGOLO	POUF	KOMODO 5
BIANCO rosa quarzo #		40371.00.066	40372.00.066	40373.00.066	40374.00.066	40369.00.066 40370.00.066
ANTRACITE rosa quarzo #		40371.02.066	40372.02.066	40373.02.066	40374.02.066	40369.02.066 40370.02.066
TORTORA rosa quarzo #		40371.10.066	40372.10.066	40373.10.066	40374.10.066	40369.10.066 40370.10.066
AGAVE rosa quarzo #		40371.16.066	40372.16.066	40373.16.066	40374.16.066	40369.16.066 40370.16.066
BIANCO grigio #		40371.00.163	40372.00.163	40373.00.163	40374.00.163	40369.00.163 40370.00.163
ANTRACITE grigio #		40371.02.163	40372.02.163	40373.02.163	40374.02.163	40369.02.163 40370.02.163
TORTORA grigio #		40371.10.163	40372.10.163	40373.10.163	40374.10.163	40369.10.163 40370.10.163
AGAVE grigio #		40371.16.163	40372.16.163	40373.16.163	40374.16.163	40369.16.163 40370.16.163

Variazioni di colore sono da ritenersi standard e naturali nei tessuti acrilici tinto filo. Posizionare in zone d'ombra - Colour variations are to be considered standard and natural in yarn-dyed acrylic fabrics. Position in shaded areas - Les variations de couleur des tissus acryliques au fil teint sont standard et naturelles. Placer dans des zones ombragées - Farbveränderungen sind als Standard und in im Garn gefärbten Acrylgeweben als natürlich zu betrachten. In schattigen Bereichen aufstellen - Las variaciones de color son normales y naturales en las telas acrílicas teñidas en hilo. Colocar en zonas de sombra - As variações de cor são consideradas standard e naturais nos tecidos acrílico tingidos com fio. Posicionar em zonas de sombra - Boyalı akrilik iplik kumaşlarda renk değişiklikleri standart ve doğal kabul edilir. Gölgeli alanlara yerleştiriniz - Изменения цвета следует считать нормой, они являются естественными в случае акриловых тканей с окрашенными волокнами. Размещать в тени.



	POLTRONA	ELEMENTO TERMINALE DX/SX	ELEMENTO CENTRALE	ELEMENTO ANGOLO	POUF	KOMODO 5
BIANCO adriatic Sunbrella® *		40371.00.142	40372.00.142	40373.00.142	40374.00.142	40369.00.142 40370.00.142
ANTRACITE adriatic Sunbrella® *		40371.02.142	40372.02.142	40373.02.142	40374.02.142	40369.02.142 40370.02.142
TORTORA adriatic Sunbrella® *		40371.10.142	40372.10.142	40373.10.142	40374.10.142	40369.10.142 40370.10.142
AGAVE adriatic Sunbrella® *		40371.16.142	40372.16.142	40373.16.142	40374.16.142	40369.16.142 40370.16.142
BIANCO ghiaccio Sunbrella® *		40371.00.138	40372.00.138	40373.00.138	40374.00.138	40369.00.138 40370.00.138
ANTRACITE ghiaccio Sunbrella® *		40371.02.138	40372.02.138	40373.02.138	40374.02.138	40369.02.138 40370.02.138
TORTORA ghiaccio Sunbrella® *		40371.10.138	40372.10.138	40373.10.138	40374.10.138	40369.10.138 40370.10.138
AGAVE ghiaccio Sunbrella® *		40371.16.138	40372.16.138	40373.16.138	40374.16.138	40369.16.138 40370.16.138

* Trattamento laminato su richiesta con quantità minima. - Laminated finish available on request with a minimum quantity. - Traitement laminé sur demande avec une quantité minimum. - Laminierete Ausrüstung auf Anfrage mit einer Mindestmenge. - Tratamiento laminado bajo pedido con una cantidad mínima. - Tratamento laminado sob encomenda com quantidade mínima. - Talep üzerine minimum miktarda lamine işlem. - Ламинированная обработка по запросу с минимальным количеством.



	POLTRONA	ELEMENTO TERMINALE DX/SX	ELEMENTO CENTRALE	ELEMENTO ANGOLO	POUF	KOMODO 5
BIANCO avocado Sunbrella® *		40371.00.139	40372.00.139	40373.00.139	40374.00.139	40369.00.139 40370.00.139
ANTRACITE avocado Sunbrella® *		40371.02.139	40372.02.139	40373.02.139	40374.02.139	40369.02.139 40370.02.139
TORTORA avocado Sunbrella® *		40371.10.139	40372.10.139	40373.10.139	40374.10.139	40369.10.139 40370.10.139
AGAVE avocado Sunbrella® *		40371.16.139	40372.16.139	40373.16.139	40374.16.139	40369.16.139 40370.16.139
BIANCO giungla Sunbrella® *		40371.00.140	40372.00.140	40373.00.140	40374.00.140	40369.00.140 40370.00.140
ANTRACITE giungla Sunbrella® *		40371.02.140	40372.02.140	40373.02.140	40374.02.140	40369.02.140 40370.02.140
TORTORA giungla Sunbrella® *		40371.10.140	40372.10.140	40373.10.140	40374.10.140	40369.10.140 40370.10.140
AGAVE giungla Sunbrella® *		40371.16.140	40372.16.140	40373.16.140	40374.16.140	40369.16.140 40370.16.140

* Trattamento laminato su richiesta con quantità minima. - Laminated finish available on request with a minimum quantity. - Traitement laminé sur demande avec une quantité minimum. - Laminierete Ausrüstung auf Anfrage mit einer Mindestmenge. - Tratamiento laminado bajo pedido con una cantidad mínima. - Tratamento laminado sob encomenda com quantidade mínima. - Tolep üzzerine minimum miktarda lamine işlem. - Ламинированная обработка по запросу с минимальным количеством.



	POLTRONA	ELEMENTO TERMINALE DX/SX	ELEMENTO CENTRALE	ELEMENTO ANGOLO	POUF	KOMODO 5
BIANCO canvas Sunbrella® *		40371.00.141	40372.00.141	40373.00.141	40374.00.141	40369.00.141 40370.00.141
ANTRACITE canvas Sunbrella® *		40371.02.141	40372.02.141	40373.02.141	40374.02.141	40369.02.141 40370.02.141
TORTORA canvas Sunbrella® *		40371.10.141	40372.10.141	40373.10.141	40374.10.141	40369.10.141 40370.10.141
AGAVE canvas Sunbrella® *		40371.16.141	40372.16.141	40373.16.141	40374.16.141	40369.16.141 40370.16.141
BIANCO TECH panama		40371.00.131	40372.00.131	40373.00.131	40374.00.131	40369.00.131 40370.00.131
ANTRACITE TECH panama		40371.02.131	40372.02.131	40373.02.131	40374.02.131	40369.02.131 40370.02.131
TORTORA TECH panama		40371.10.131	40372.10.131	40373.10.131	40374.10.131	40369.10.131 40370.10.131
AGAVE TECH panama		40371.16.131	40372.16.131	40373.16.131	40374.16.131	40369.16.131 40370.16.131

* Trattamento laminato su richiesta con quantità minima. - Laminated finish available on request with a minimum quantity. - Traitement laminé sur demande avec une quantité minimum. - Laminierete Ausrüstung auf Anfrage mit einer Mindestmenge. - Tratamiento laminado bajo pedido con una cantidad mínima. - Tratamento laminado sob encomenda com quantidade mínima. - Tolep üzzerine minimum miktarda lamine işlem. - Ламинированная обработка по запросу с минимальным количеством.

KOMODO TAVOLINO

polipropilene fiberglass

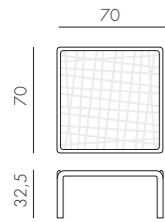
6,7 kg
n. pz. 1

BIANCO 40378.00.000 ANTRACITE 40378.02.000
TORTORA 40378.10.000 AGAVE 40378.16.000

KOMODO TAVOLINO VETRO

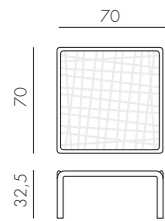
polipropilene fiberglass
vetro11,4 kg
n. pz. 1

BIANCO vetro 40368.00.501 ANTRACITE vetro 40368.02.501
TORTORA vetro 40368.10.501 AGAVE vetro 40368.16.501

KOMODO BRACCIOLO

polipropilene fiberglass

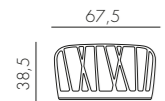
1,7 kg
n. pz. 2

BIANCO 40375.00.000 ANTRACITE 40375.02.000
TORTORA 40375.10.000 AGAVE 40375.16.000

KOMODO SCHIENALE

polipropilene fiberglass

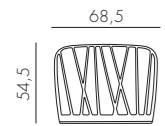
2 kg
n. pz. 4

BIANCO 40376.00.000 ANTRACITE 40376.02.000
TORTORA 40376.10.000 AGAVE 40376.16.000

CUSCINO SCHIENALE KOMODO

tessuto

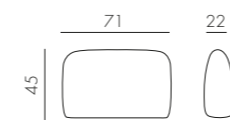
1,4 kg
n. pz. 1

rosa quarzo # 36370.52.066 grigio # 36370.52.163
adriatic Sunbrella®* 36370.52.142 ghiaccio Sunbrella®* 36370.52.138
avocado Sunbrella®* 36370.52.139



giungla Sunbrella®* 36370.52.140 canvas Sunbrella®* 36370.52.141
TECH panama 36370.52.131

CUSCINO SCHIENALE ANGOLO KOMODO

tessuto

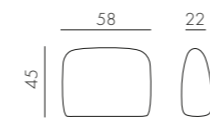
1,1 kg
n. pz. 1

rosa quarzo # 36370.54.066 grigio # 36370.54.163
adriatic Sunbrella®* 36370.54.142 ghiaccio Sunbrella®* 36370.54.138
avocado Sunbrella®* 36370.54.139



giungla Sunbrella®* 36370.54.140 canvas Sunbrella®* 36370.54.141
TECH panama 36370.54.131

Variazioni di colore sono da ritenersi standard e naturali nei tessuti acrilici tinto filo. Posizionare in zone d'ombra - Colour variations are to be considered standard and natural in yarn-dyed acrylic fabrics. Position in shaded areas - Les variations de couleur des tissus acryliques au fil teint sont standard et naturelles. Placer dans des zones ombragées - Farbveränderungen sind als Standard und in im Garn gefärbten Acrylgeweben als natürlich zu betrachten. In schattigen Bereichen aufstellen - Las variaciones de color son normales y naturales en las telas acrílicas teñidas en hilo. Colocar en zonas de sombra - As variações de cor são consideradas standard e naturais nos tecidos acrílico tingidos com fio. Posicionar em zonas de sombra - Boyalı akrilik iplik kumaşlarda renk değişiklikleri standart ve doğal kabul edilir. Gölgeli alanlara yerleştiriniz - Изменения цвета следует считать нормой, они являются естественными в случае акриловых тканей с окрашенными волокнами. Размещать в тени.

* Trattamento laminato su richiesta con quantità minima. - Laminated finish available on request with a minimum quantity. - Traitement laminé sur demande avec une quantité minimum. - Laminierter Ausrüstung auf Anfrage mit einer Mindestmenge. - Tratamiento laminado bajo pedido con una cantidad mínima. - Tratamento laminado sob encomenda com quantidade mínima. - Talep üzerine minimum miktarda lamine işlem. - Ламинированная обработка по запросу с минимальным количеством.

TRILL ARMCHAIR

polipropilene fiberglass

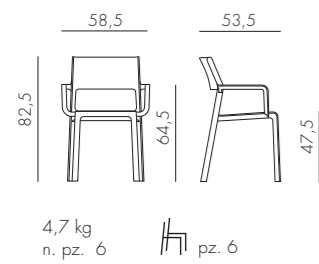

TRILL STOOL

polipropilene fiberglass

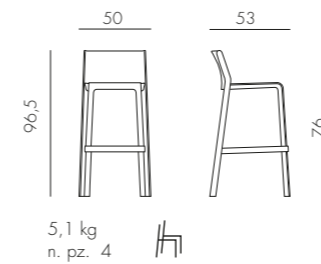

TRILL BISTROT

polipropilene fiberglass

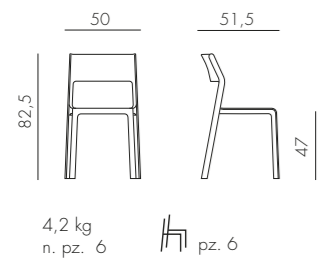

TRILL STOOL MINI

polipropilene fiberglass

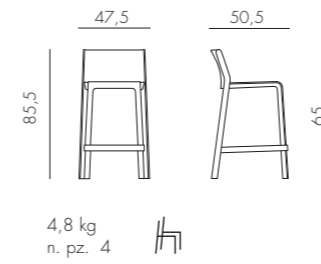

NET BENCH

polipropilene fiberglass

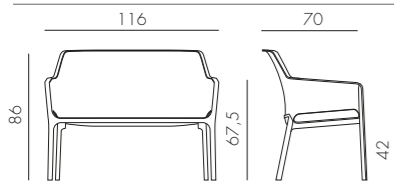

8,9 kg
n. pz. 20



BIANCO 40338.00.000 ANTRACITE 40338.02.000 SALICE 40338.04.000 TORTORA 40338.10.000 SENAPE 40338.56.000 CORALLO 40338.75.000

NET RELAX

polipropilene fiberglass

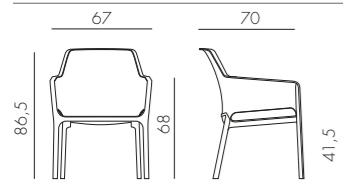

4,9 kg
n. pz. 20



pz. 6



BIANCO 40327.00.000 ANTRACITE 40327.02.000 SALICE 40327.04.000 TORTORA 40327.10.000 SENAPE 40327.56.000 CORALLO 40327.75.000

NET

polipropilene fiberglass

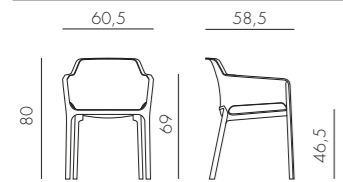

3,9 kg
n. pz. 6



pz. 6



BIANCO 40326.00.000.06 ANTRACITE 40326.02.000.06 SALICE 40326.04.000.06 TORTORA 40326.10.000.06 SENAPE 40326.56.000.06 CORALLO 40326.75.000.06

BIT

polipropilene fiberglass

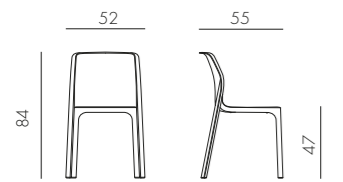

3,5 kg
n. pz. 6



pz. 6



BIANCO 40328.00.000.06 ANTRACITE 40328.02.000.06 SALICE 40328.04.000.06 TORTORA 40328.10.000.06 SENAPE 40328.56.000.06 CORALLO 40328.75.000.06

NET STOOL

polipropilene fiberglass

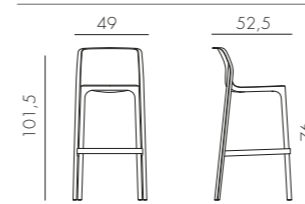

4,4 kg
n. pz. 4



BIANCO 40355.00.000 ANTRACITE 40355.02.000 SALICE 40355.04.000 TORTORA 40355.10.000 SENAPE 40355.56.000 CORALLO 40355.75.000

NET STOOL MINI

polipropilene fiberglass

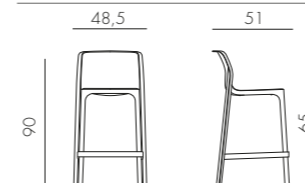

4,2 kg
n. pz. 4



BIANCO 40356.00.000 ANTRACITE 40356.02.000 SALICE 40356.04.000 TORTORA 40356.10.000 SENAPE 40356.56.000 CORALLO 40356.75.000

PALMA

polipropilene

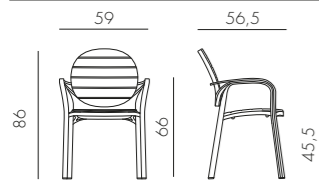
5,2 kg
n. pz. 6

BIANCO 40237.00.000
 BIANCO TORTORA 40237.00.010
 ANTRACITE 40237.02.002
 CAFFÈ 40237.05.005
 TORTORA 40237.10.010

ERICA

polipropilene

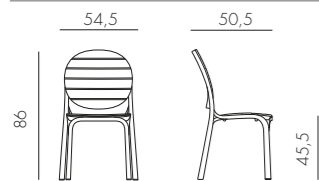
4,2 kg
n. pz. 22

BIANCO 40236.00.000
 BIANCO TORTORA 40236.00.010
 ANTRACITE 40236.02.002
 CAFFÈ 40236.05.005
 TORTORA 40236.10.010

NINFEA DINNER

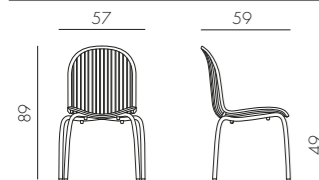
polipropilene
alluminio4,5 kg
n. pz. 6

ANTRACITE vernic. antracite 62052.02.000
 BIANCO vernic. bianco 62053.00.000

NINFEA RELAX

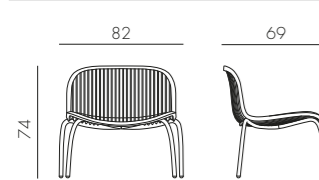
polipropilene
alluminio7,2 kg
n. pz. 2

ANTRACITE vernic. antracite 62252.02.000
 BIANCO vernic. bianco 62253.00.000

ARIA (POLTRONA ARIA + CUSCINO SEDUTA + CUSCINO ARREDO)

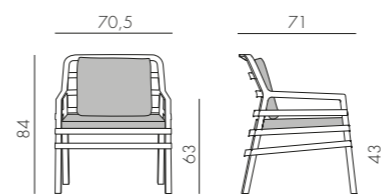
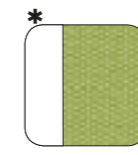
polipropilene
tessuto7,9 kg
n. pz. 1

BIANCO lime #
40330.00.061.061

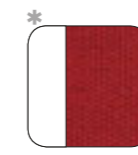

BIANCO cherry #
40330.00.065.065

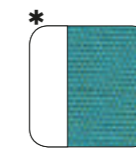

BIANCO sardinia #
40330.00.072.072

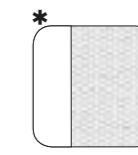

BIANCO bianco
40330.00.155.155

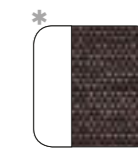

BIANCO caffè
40330.00.165.165

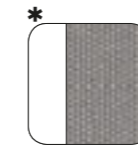

BIANCO grigio #
40330.00.163.163

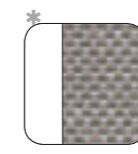

BIANCO grigio Sunbrella®
40330.00.136.136

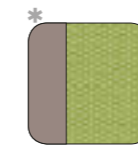

TORTORA lime #
40330.10.061.061

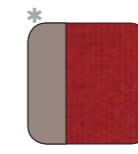

TORTORA cherry #
40330.10.065.065

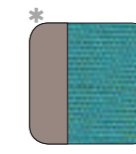

TORTORA sardinia #
40330.10.072.072

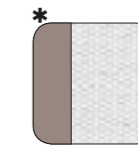

TORTORA bianco
40330.10.155.155

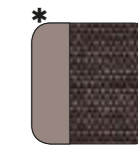

TORTORA caffè
40330.10.165.165

* Disponibile a magazzino
 Available ex-stock
 Disponible sur stock
 Ab Lager verfügbar
 Disponible en almacén habitualmente
 Disponivel em estoque
 Stokta mevcut
 Наличие на складе

* Disponibile su ordine
 Available to order
 Disponible sur commande
 Mit Auftrag verfügbar
 Disponible sólo sobre pedido
 Disponivel sob encomenda
 Sipariş göre hazırlanacaktır
 Под заказ

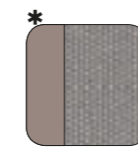

TORTORA grigio #
40330.10.163.163

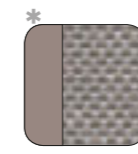

TORTORA grigio Sunbrella®
40330.10.136.136

ARIA FIT (POLTRONA ARIA + CUSCINO SEDUTA + CUSCINO FIT)

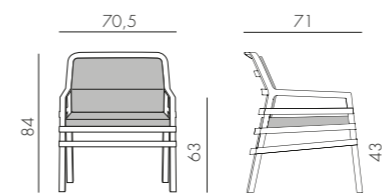
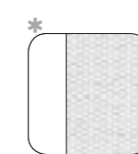
polipropilene
tessuto7,9 kg
n. pz. 1

BIANCO bianco
40330.00.155.FIT



BIANCO caffè
40330.00.165.FIT

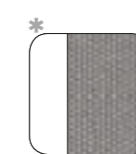

BIANCO grigio #
40330.00.163.FIT

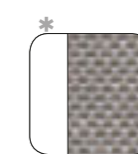

BIANCO grigio Sunbrella®
40330.00.136.FIT

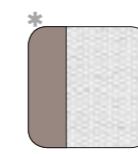

TORTORA bianco
40330.10.155.FIT



TORTORA caffè
40330.10.165.FIT

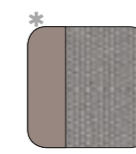

TORTORA grigio #
40330.10.163.FIT

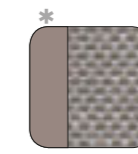

TORTORA grigio Sunbrella®
40330.10.136.FIT

* Disponibile su ordine
 Available to order
 Disponible sur commande
 Mit Auftrag verfügbar
 Disponible sólo sobre pedido
 Disponivel sob encomenda
 Sipariş göre hazırlanacaktır
 Под заказ

Variazioni di colore sono da ritenersi standard e naturali nei tessuti acrilici tinto filo. Posizionare in zone d'ombra - Colour variations are to be considered standard and natural in yarn-dyed acrylic fabrics. Position in shaded areas - Les variations de couleur des tissus acryliques au fil teint sont standard et naturelles. Placer dans des zones ombragées - Farbveränderungen sind als Standard und in im Garn gefärbten Acrylgeweben als natürlich zu betrachten. In schattigen Bereichen aufstellen - Las variaciones de color son normales y naturales en las telas acrílicas teñidas en hilo. Colocar en zonas de sombra - As variações de cor são consideradas standard e naturais nos tecidos acrílico tingidos com fio. Posicionar em zonas de sombra - Boyalı akrilik iplik kumaşlarda renk değişiklikleri standart ve doğal kabul edilir. Gölge alanlara yerleştiriniz - Изменения цвета следует считать нормой, они являются естественными в случае акриловых тканей с окрашенными волокнами. Размещать в тени.

ATLANTICO

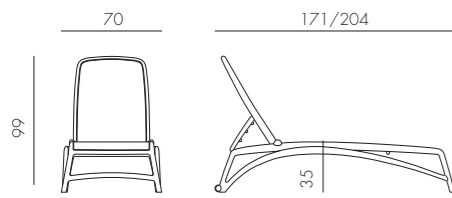

16 kg
n. pz. 20

Tessuto ricambiabile
Replaceable fabric
Tissu changeable
Auswechselbarer Stoff
Tela sustituible
Tecidos recambiables
Değiştirilebilen Kumaş
Съемная ткань



polipropilene fiberglass
tessuto sintetico

RICAMBIO atlantico

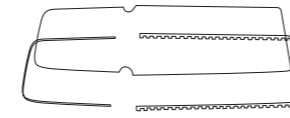

1,3 kg
n. pz. 1

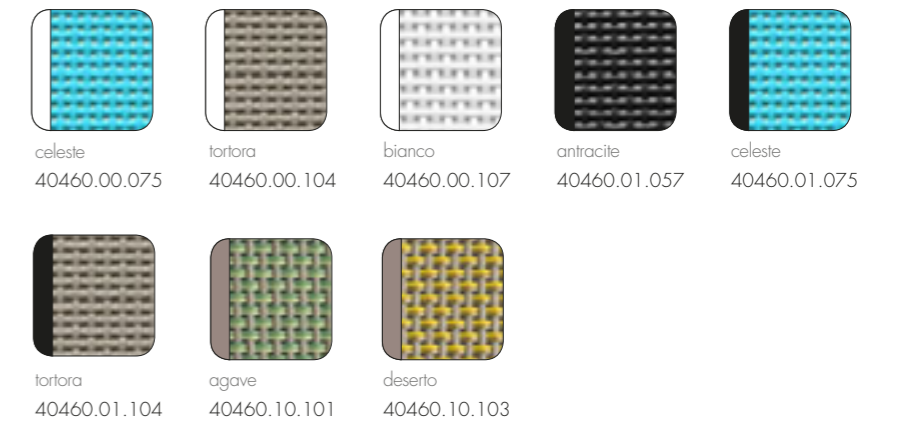

resina acetilica
tessuto sintetico

BRACCIOLO ATLANTICO

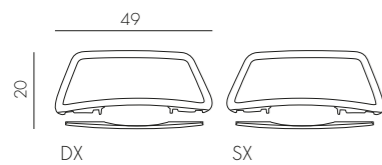

1,1 kg
n. pz. 1

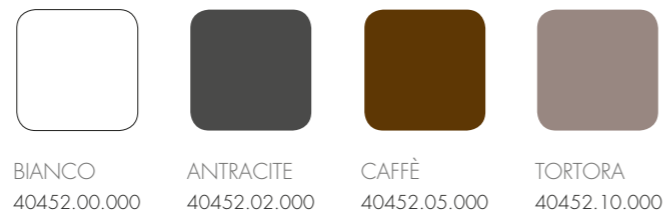

polipropilene fiberglass

RIO - RIO ALU

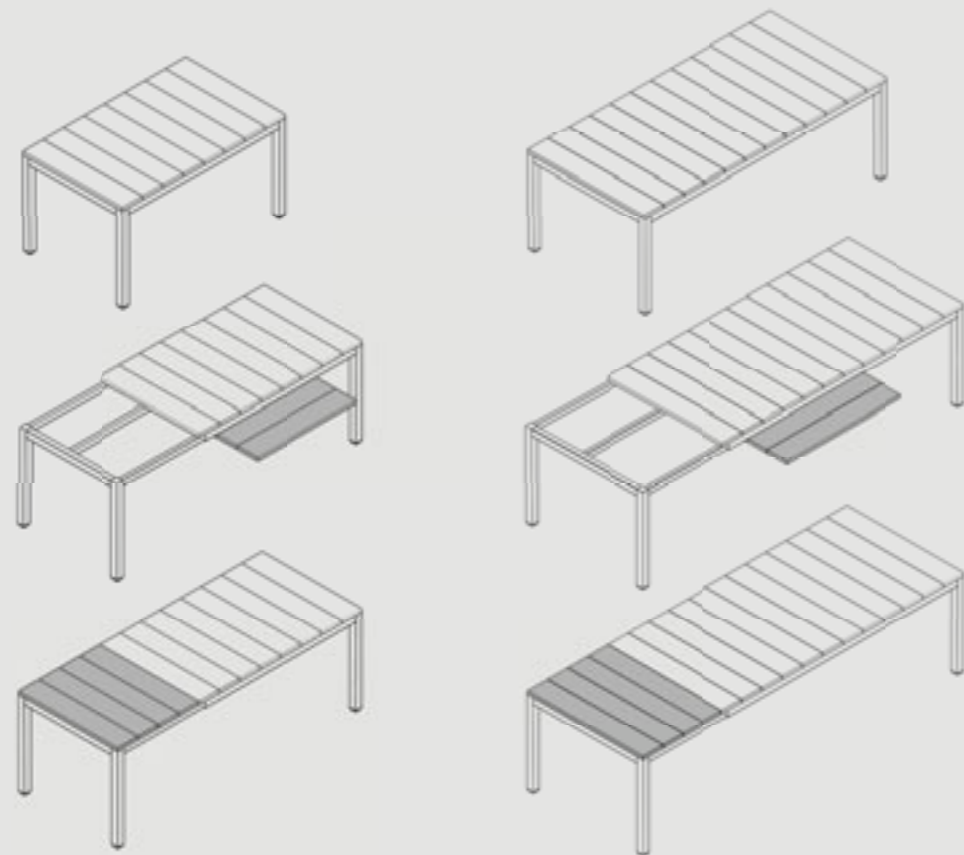

rio 140 extensible
6/8 140/210x85x76 cm

rio Alu 140 extensible
6/8 140/210x85x75 cm

rio 210 extensible
8/10 210/280x100x76 cm

rio Alu 210 extensible
8/10 210/280x100x75 cm

RIO ALU 210 EXTENSIBLE 8/10

alluminio

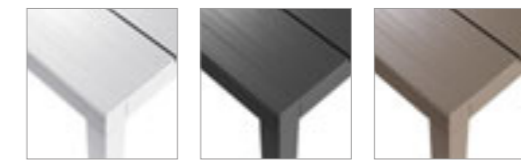
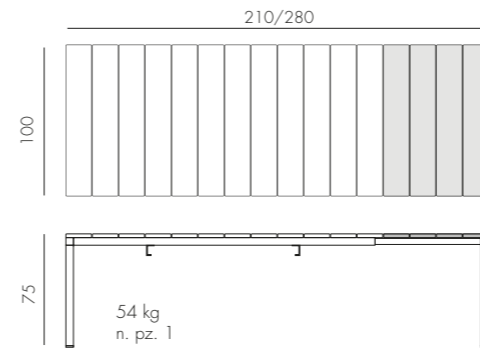

verniciato bianco
48853.00.000

verniciato antracite
48852.02.000

verniciato tortora
48859.10.000

RIO ALU 140 EXTENSIBLE 6/8

alluminio

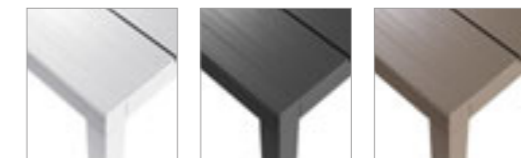
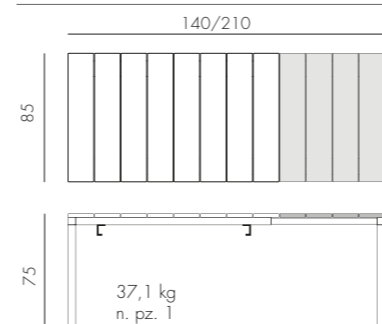

verniciato bianco
48653.00.000

verniciato antracite
48652.02.000

verniciato tortora
48659.10.000

RIO 210 EXTENSIBLE 8/10

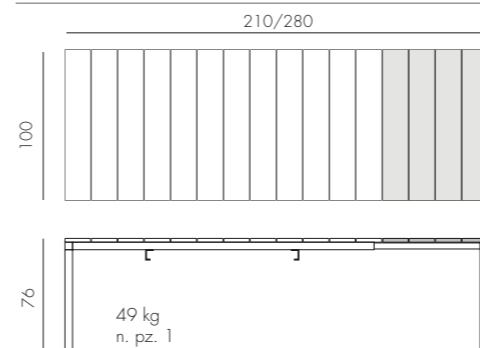
durelTOP - polipropilene
alluminio

BIANCO
verniciato bianco
48253.00.000

ANTRACITE*
verniciato antracite
48252.02.000

TORTORA
verniciato tortora
48259.10.000

RIO 140 EXTENSIBLE 6/8

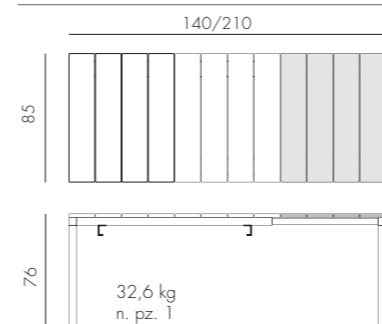
durelTOP - polipropilene
alluminio

BIANCO
verniciato bianco
48353.00.000

ANTRACITE*
verniciato antracite
48352.02.000

TORTORA
verniciato tortora
48359.10.000

* Posizionare in zona d'ombra - Only use table tops in shaded areas - Plateaux qui doivent être utilisés uniquement dans des zones ombragées - Tischplatten nur für beschatteten Einsatzbereich - Utilizar estos tableros sólo en áreas sombreadas - Colocar em local sombreado - Gölge alana koyun - Ставить в тени

ALLORO

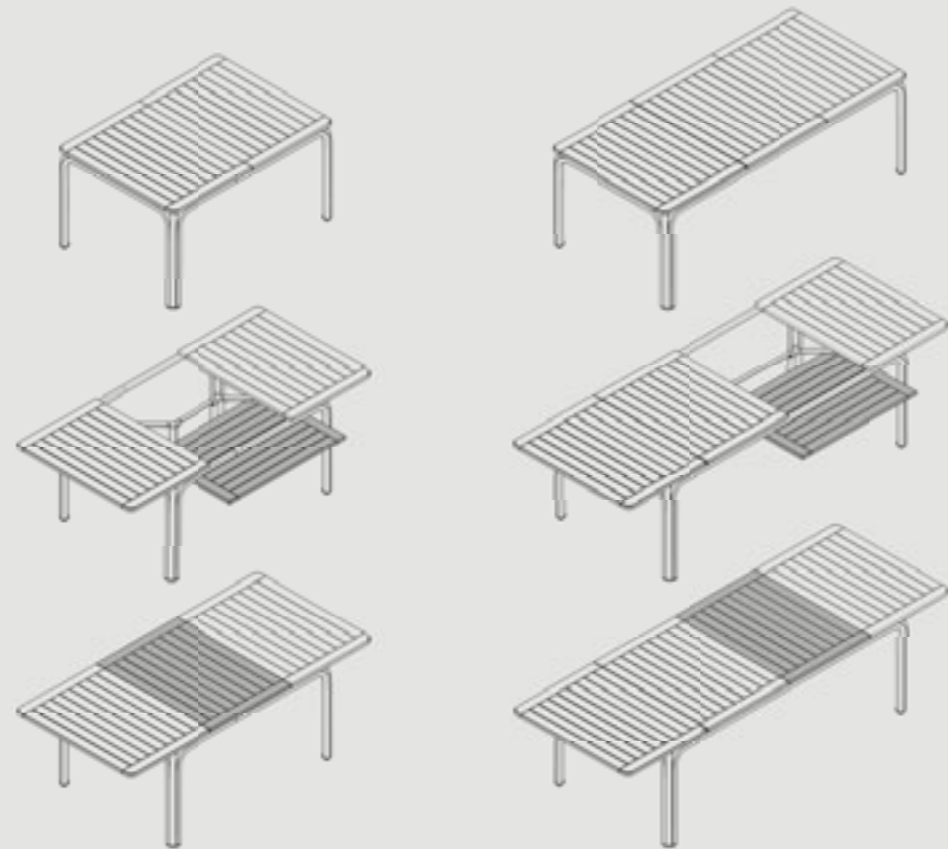

alloro 140 extensible
6/8 🧑‍🤝‍🧑 140/210x100x73 cm

alloro 210 extensible
8/10 🧑‍🤝‍🧑 210/280x100x73 cm

durelTOP - polipropilene
alluminio

ALLORO 210 EXTENSIBLE 8/10 🧑‍🤝‍🧑

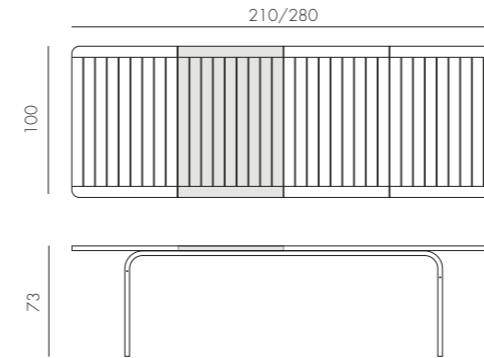

44,4 kg
n. pz. 1

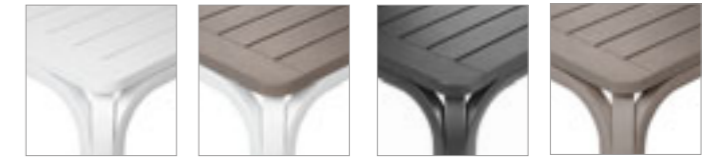

BIANCO
verniciato bianco
42853.00.000

TORTORA
verniciato bianco
42853.10.000

ANTRACITE*
verniciato antracite
42852.02.000

TORTORA
verniciato tortora
42859.10.000

ALLORO 140 EXTENSIBLE 6/8 🧑‍🤝‍🧑

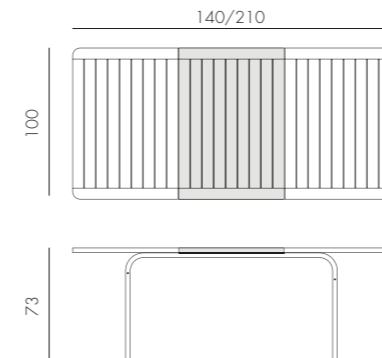

33,7 kg
n. pz. 1

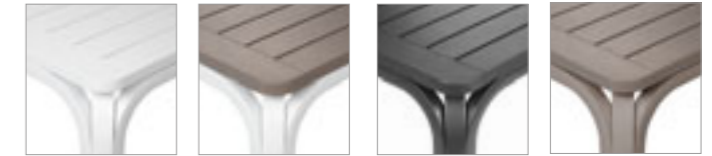

BIANCO
verniciato bianco
42753.00.000

TORTORA
verniciato bianco
42753.10.000

ANTRACITE*
verniciato antracite
42752.02.000

TORTORA
verniciato tortora
42759.10.000

durelTOP - polipropilene
alluminio

* Posizionare in zona d'ombra - Only use table tops in shaded areas - Plateaux qui doivent être utilisés uniquement dans des zones ombragées - Tischplatten nur für beschatteten Einsatzbereich - Utilizar estos tableros sólo en áreas sombreadas - Colocar em local sombreado - Gölge alana koyun - Ставить в тени

LOTO DINNER 190

vetro
alluminio

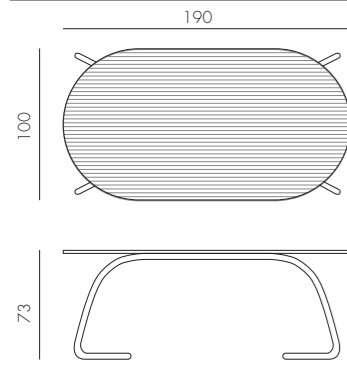

ANTRACITE
verniciato antracite
44052.02.000



BIANCO
verniciato bianco
44053.00.000

49,8 kg
n. pz. 1

LOTO DINNER Ø170

vetro
alluminio

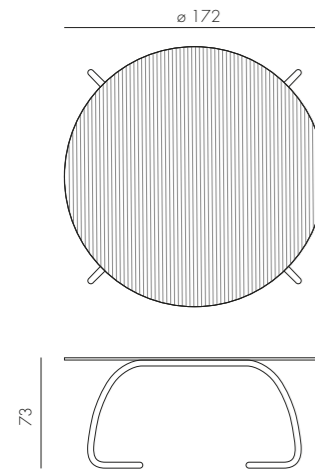

ANTRACITE
verniciato antracite
44452.02.000



BIANCO
verniciato bianco
44453.00.000

65,3 kg
n. pz. 1

LOTO RELAX 95

vetro
alluminio

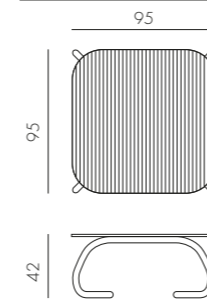

ANTRACITE
verniciato antracite
44752.02.000



BIANCO
verniciato bianco
44753.00.000

27 kg
n. pz. 1

LOTO RELAX 60

laminato
alluminio



ANTRACITE *
verniciato antracite
44652.00.303



BIANCO
verniciato bianco
44653.00.301

7 kg
n. pz. 1

* Posizionare in zona d'ombra - Only use table tops in shaded areas - Plateaux qui doivent être utilisés uniquement dans des zones ombragées - Tischplatten nur für beschatteten Einsatzbereich - Utilizar estos tableros sólo en áreas sombreadas - Colocar em local sombreado - Gölge alana koyun - Ставить в тени

CUBE 140X80

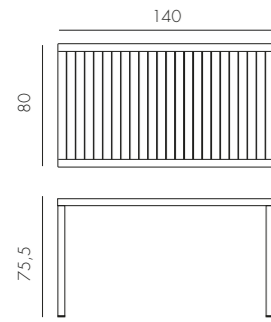
durelTOP - polipropilene
alluminio

BIANCO verniciato bianco 47753.00.000	ANTRACITE * verniciato antracite 47752.02.000	CAFFÈ * verniciato caffè 47757.05.000	TORTORA verniciato tortora 47759.10.000
---	---	---	---

16,9 kg
n. pz. 1

CUBE 80

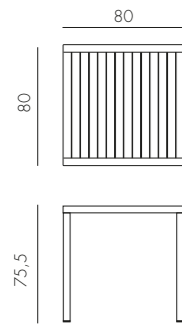
durelTOP - polipropilene
alluminio

BIANCO verniciato bianco 48053.00.000	ANTRACITE verniciato antracite 48052.02.000	CAFFÈ verniciato caffè 48057.05.000	TORTORA verniciato tortora 48059.10.000
---	---	---	---

11,5 kg
n. pz. 1

CUBE 70

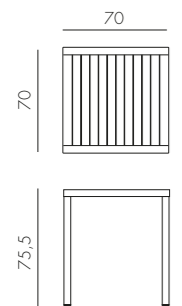
durelTOP - polipropilene
alluminio

BIANCO verniciato bianco 47853.00.000	ANTRACITE verniciato antracite 47852.02.000	CAFFÈ verniciato caffè 47857.05.000	TORTORA verniciato tortora 47859.10.000
---	---	---	---

9,5 kg
n. pz. 1

NET TABLE 100

polipropilene fiberglass

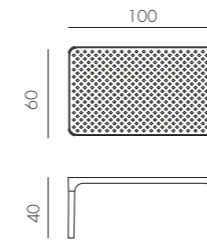
6,3 kg
n. pz. 1

BIANCO 40064.00.000	ANTRACITE 40064.02.000	SALICE 40064.04.000	TORTORA 40064.10.000	SENAPE 40064.56.000	CORALLO 40064.75.000
------------------------	---------------------------	------------------------	-------------------------	------------------------	-------------------------

ARIA TAVOLINO 100

polipropilene

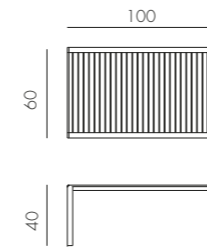
8 kg
n. pz. 1

BIANCO 40052.00.000	TORTORA 40052.10.000
------------------------	-------------------------

ARIA TAVOLINO 60

polipropilene

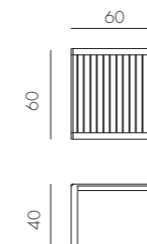
5 kg
n. pz. 1

BIANCO 40051.00.000	TORTORA 40051.10.000
------------------------	-------------------------

POP

polipropilene fiberglass

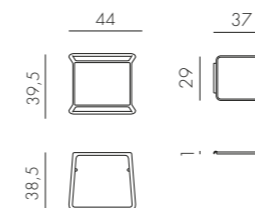
2,5 kg
n. pz. 4 

BIANCO 40048.00.000	ANTRACITE 40048.02.000	CAFFÈ 40048.05.000	TORTORA 40048.10.000
------------------------	---------------------------	-----------------------	-------------------------

* Posizionare in zona d'ombra - Only use table tops in shaded areas - Plateaux qui doivent être utilisés uniquement dans des zones ombragées - Tischplatten nur für beschatteten Einsatzbereich - Utilizar estos tableros sólo en áreas sombreadas - Colocar em local sombreado - Gölge alana koyun - Ставить в тени

CUSCINO NET BENCH

tessuto

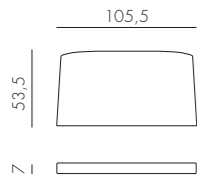
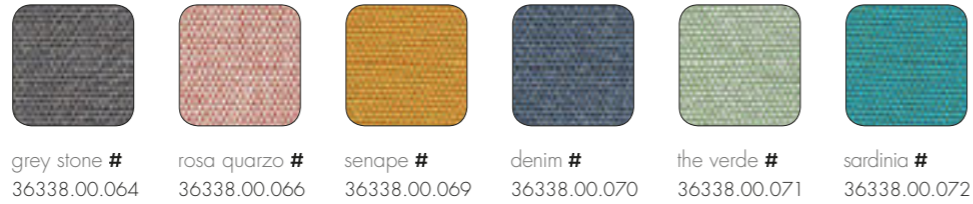
1,5 kg
n. pz. 4

CUSCINO NET RELAX

tessuto

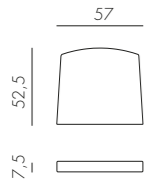
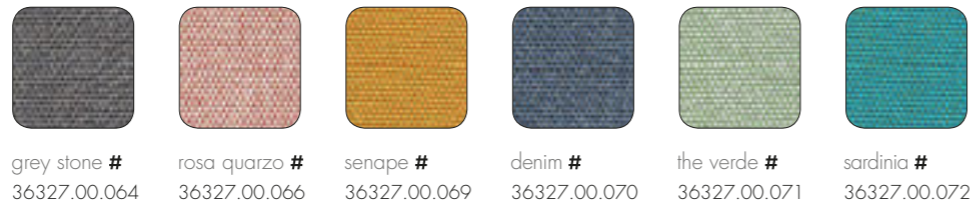
0,8 kg
n. pz. 4

Variazioni di colore sono da ritenersi standard e naturali nei tessuti acrilici tinto filo. Posizionare in zone d'ombra - Colour variations are to be considered standard and natural in yarn-dyed acrylic fabrics. Position in shaded areas - Les variations de couleur des tissus acryliques au fil teint sont standard et naturelles. Placer dans des zones ombragées - Farbveränderungen sind als Standard und in im Garn gefärbten Acrylgeweben als natürlich zu betrachten. In schattigen Bereichen aufstellen - Las variaciones de color son normales y naturales en las telas acrílicas teñidas en hilo. Colocar en zonas de sombra - As variações de cor são consideradas standard e naturais nos tecidos acrílico tingidos com fio. Posicionar em zonas de sombra - Boyalı akrilik iplik kumaşlarda renk değişiklikleri standart ve doğal kabul edilir. Gölge alanlara yerleştiriniz - Изменения цвета следует считать нормой, они являются естественными в случае акриловых тканей с окрашенными волокнами. Размещать в тени.

* Trattamento laminato su richiesta con quantità minima. - Laminated finish available on request with a minimum quantity. - Traitement laminé sur demande avec une quantité minimum. - Laminierete Ausrüstung auf Anfrage mit einer Mindestmenge. - Tratamiento laminado bajo pedido con una cantidad mínima. - Tratamento laminado sob encomenda com quantidade mínima. - Talep üzerine minimum miktarda lamine işlem. - Ламинированная обработка по запросу с минимальным количеством.

CUSCINO SHELL (NET RELAX)

tessuto

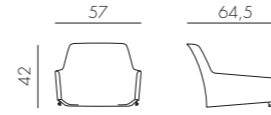
2,2 kg
n. pz. 2

Utilizzabile solo con cuscino Net Relax - Can only be used with Net Relax cushion - À utiliser uniquement avec le coussin Net Relax - Kann nur mit Net Relax Kissen verwendet werden - Se puede utilizar sólo con el cojín Net Relax - Só pode ser usada em conjunto com almofada de assento Net Relax - Sadece Net Relax minderiyile kullanılmalı - Можно использовать только с подушкой Net Relax.

CUSCINO NET

tessuto

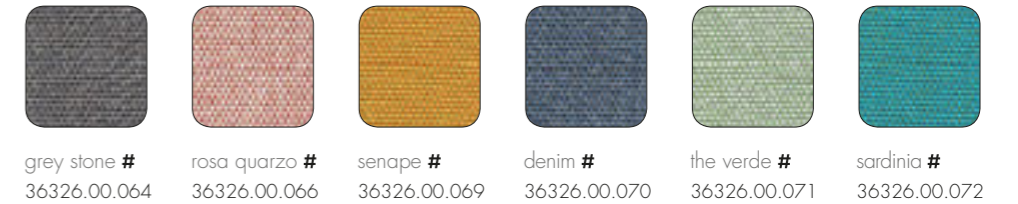
0,3 kg
n. pz. 4

CUSCINO TRILL

tessuto

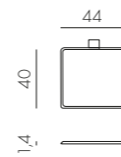
0,2 kg
n. pz. 4

Solo per sedia Trill Bistrot - Only for Trill Bistrot chair - Seulement pour la chaise Trill Bistrot - Nur für Trill Bistrot Stuhl - Sólo para silla Trill Bistrot - Apenas para cadeira Trill Bistrot - Sadece Trill Bistrot sandalyesi için - Только для кресла Trill Bistrot.

Variazioni di colore sono da ritenersi standard e naturali nei tessuti acrilici tinto filo. Posizionare in zone d'ombra - Colour variations are to be considered standard and natural in yarn-dyed acrylic fabrics. Position in shaded areas - Les variations de couleur des tissus acryliques au fil teint sont standard et naturelles. Placer dans des zones ombragées - Farbveränderungen sind als Standard und in im Garn gefärbten Acrylgeweben als natürlich zu betrachten. In schattigen Bereichen aufstellen - Las variaciones de color son normales y naturales en las telas acrílicas teñidas en hilo. Colocar en zonas de sombra - As variações de cor são consideradas standard e naturais nos tecidos acrílico tingidos com fio. Posicionar em zonas de sombra - Boyalı akrilik iplik kumaşlarda renk değişiklikleri standart ve doğal kabul edilir. Gölge alanlara yerleştiriniz - Изменения цвета следует считать нормой, они являются естественными в случае акриловых тканей с окрашенными волокнами. Размещать в тени.

* Trattamento laminato su richiesta con quantità minima. - Laminated finish available on request with a minimum quantity. - Traitement laminé sur demande avec une quantité minimum. - Laminierete Ausrüstung auf Anfrage mit einer Mindestmenge. - Tratamiento laminado bajo pedido con una cantidad mínima. - Tratamento laminado sob encomenda com quantidade mínima. - Talep üzerine minimum miktarda lamine işlem. - Ламинированная обработка по запросу с минимальным количеством.

CUSCINO PASSEPARTOUT

tessuto

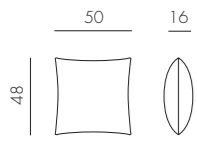
0,7 kg
n. pz. 4grey stone #
36000.01.064rosa quarzo #
36000.01.066senape #
36000.01.069denim #
36000.01.070the verde #
36000.01.071sardinia #
36000.01.072tropical
36000.01.081bianco
36000.01.155grigio #
36000.01.163grigio Sunbrella®
36000.01.136adriatic Sunbrella®
36000.01.142ghiaccio Sunbrella®
36000.01.138avocado Sunbrella®
36000.01.139giungla Sunbrella®
36000.01.140

CUSCINO RETTANGOLARE

tessuto

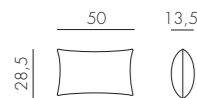
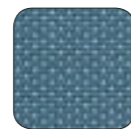
0,55 kg
n. pz. 4rosa quarzo #
36000.02.066grigio #
36000.02.163adriatic Sunbrella®
36000.02.142ghiaccio Sunbrella®
36000.02.138avocado Sunbrella®
36000.02.139giungla Sunbrella®
36000.02.140materiali
materials

Variazioni di colore sono da ritenersi standard e naturali nei tessuti acrilici tinto filo. Posizionare in zone d'ombra - Colour variations are to be considered standard and natural in yarn-dyed acrylic fabrics. Position in shaded areas - Les variations de couleur des tissus acryliques au fil teint sont standard et naturelles. Placer dans des zones ombragées - Farbveränderungen sind als Standard und in im Garn gefärbten Acrylgeweben als natürlich zu betrachten. In schattigen Bereichen aufstellen - Las variaciones de color son normales y naturales en las telas acrílicas teñidas en hilo. Colocar en zonas de sombra - As variações de cor são consideradas standard e naturais nos tecidos acrílico tingidos com fio. Posicionar em zonas de sombra - Boyalı akrilik iplik kumaşlarda renk değişiklikleri standart ve doğal kabul edilir. Gölgeli alanlara yerleştiriniz - Изменения цвета следует считать нормой, они являются естественными в случае акриловых тканей с окрашенными волокнами. Размещать в тени.

polipropilene

Polipropilene trattato anti-UV e colorato in massa. Riciclabile al 100%.
 Polypropylene with UV additives and is uniformly colored. 100% Recyclable resin.
 Polypropylène traité anti-UV et coloré dans la masse. Résine recyclable 100%.
 UV-beständigem Polypropylen, voll durchgefärbt. 100% Recyclebarer Kunststoff.
 Polipropileno tratado anti UV y teñido en masa. Resina reciclable 100%.
 Polipropileno com tratamento anti-UV colorido na totalidade. Resina reciclável 100%.
 Işığa dayanıklı ve boyalı olarak granül çekilmiş %100 geri dönüşümlü polipropilen kompozit hammadde.
 Полипропилен с обработкой анти-УФ, окрашенное в массу. На 100% пригодно для вторичной переработки.

polipropilene fiberglass

Polipropilene fiberglass trattato anti-UV e colorato in massa. Resina riciclabile al 100%.
 Uniformly colored fiberglass polypropylene resins with uv additives. 100% Recyclable resin.
 Polypropylène fiberglass traité anti-uv et coloré dans la masse. Résine recyclable 100%.
 UV-beständigem fiberglass Polypropylen, voll durchgefärbt. 100% Recyclebarer Kunststoff.
 Polipropileno fiberglass tratado anti UV y teñido en masa. Resina reciclable 100%.
 Polipropileno fiberglass com tratamento anti-UV colorido na totalidade. Resina reciclável 100%.
 Işığa dayanıklı ve boyalı olarak granül çekilmiş %100 geri dönüşümlü cam elyaf katkılı polipropilen kompozit hammadde.
 Полипропилен фиброволокно с обработкой анти-УФ, окрашенное в массу. На 100% пригодно для вторичной переработки.



BIANCO .00



GRIGIO .03



ANTRACITE .02



TORTORA .10



TABACCO .53



CAFFE' .05



OTTANIO .49



SALICE .04



AGAVE .16



SENAPE .56



ROSA BOUQUET .08



CORALLO .75

tessuto acrilico

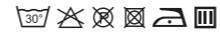

Fibra acrilica 100% tinto filo. Trattamento antimacchia, antimuffa. Solidità alla luce 5/8. Lavabile a 30°.

100% yarn dyed acrylic. Dirt repellent and anti-mould treatment. 5/8 light fastness. Washable at 30°.

100% fibre acrylique teintée en fils. Traitement anti-taches et anti-moisissure. Résistance à la lumière 5/8. Lavable à 30°.

100% garngefärbtes Polyacryl Gewebe. Gegen Flecken und Schimmel Ausrüstung. Lichtechtheit 5/8. Waschbar bei 30°.

100% hilo teñido acrílico. Protección antimanchas, antimoho. Solidez a la luz 5/8. Lavable a 30°.

100% fibra acrílica tingida com fio. Tratamento antimancha e antimoho. Resistência à luz 5/8. Lavável a 30°.

%100 akrilik elyaf boyalı iplik. Leke itici, küf önleyici ile muamele edilmiş. Işık haslığı 5/8. 30°de yıkanabilir.

Акриловое волокно 100% окрашенное в пряде. Пятноустойчивая и противоплесневая обработка. Светостойкость 5/8. Стирать при 30°.

Variazioni di colore sono da ritenersi standard e naturali nei tessuti acrilici tinto filo. Posizionare in zone d'ombra - Colour variations are to be considered standard and natural in yarn-dyed acrylic fabrics. Position in shaded areas - Les variations de couleur des tissus acryliques au fil teint sont standard et naturelles. Placer dans des zones ombragées - Farbveränderungen sind als Standard und in im Garn gefärbten Acrylgeweben als natürlich zu betrachten. In schattigen Bereichen aufstellen - Las variaciones de color

son normales y naturales en las telas acrílicas teñidas en hilo. Colocar en zonas de sombra - As variações de cor são consideradas standard e naturais nos tecidos acrílico tingidos com fio. Posicionar em zonas de sombra - Boyalı akrilik iplik kumaşlarda renk değişiklikleri standart ve doğal kabul edilir. Gölge alanlara yerleştiriniz - Изменения цвета следует считать нормой, они являются естественными в случае акриловых тканей с окрашенными волокнами. Размещать в тени.

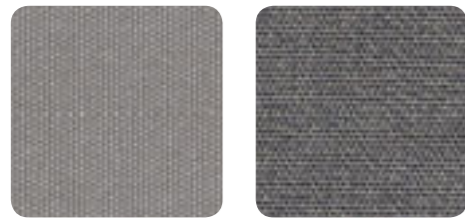

grigio .163
240 gr/m²

grey stone .064
240 gr/m²



artic .161
240 gr/m²

sardinia .072
240 gr/m²

denim .070
240 gr/m²

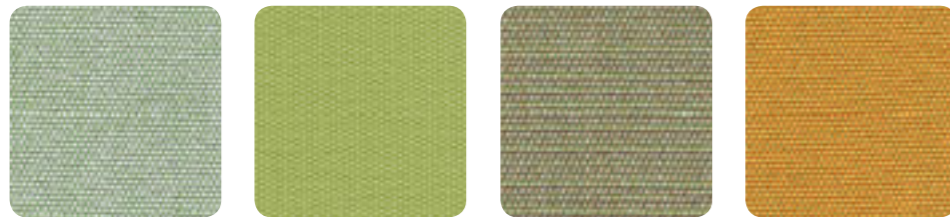

the verde .071
240 gr/m²

lime .061
240 gr/m²

felce .162
240 gr/m²

senape .069
240 gr/m²

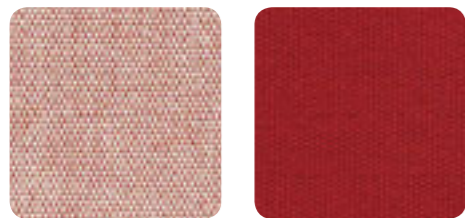

rosa quarzo .066
240 gr/m²

cherry .065
240 gr/m²

tessuto acrilico Sunbrella®



100% fibra acrilica Sunbrella® tinto in massa. Trattamento idrorepellente, antimacchia, antimuffa. Solidità alla luce 8/8. Lavabile a 40°.

100% Sunbrella® acrylic fiber mass dyed. Water repellent treatment, dirt repellent and anti-mould treatment. 8/8 light fastness. Washable at 40°.

100% fibre acrylique Sunbrella® teintée en masse. Traitement imperméable, anti-taches et anti-moisissure. Résistance à la lumière 8/8. Lavable à 40°.

100% fasergefärbtes Sunbrella® Polyacryl. Wasserabweisend Ausrüstung, gegen Flecken und Schimmel ausgerüstet. Lichtechtheit 8/8. Waschbar bei 40°.

100% fibra acrílica Sunbrella® tintada en masa. Tratamiento por la repelencia al agua, protección antimanchas, antimoho. Solidez a la luz 8/8. Lavable a 40°.

100% fibra acrílica Sunbrella® tingida em massa. Tratamento hidrorrepelente, antimancha e antimoho. Resistência à luz 8/8. Lavável a 40°.

%100 akrilik elyaf Sunbrella® çözelti halindeyken boyanmış. Su itici, leke itici, küf önleyici ile muamele edilmiş. Işık haslığı 8/8. 40°de yıkanabilir.

100% акриловое волокно Sunbrella®, окрашенное в массе. Водоотталкивающая, пятноустойчивая и противоплесневая обработка. Светостойкость 8/8. Стирать при 40°.

★ 50% fibra acrilica Sunbrella® riciclata tinto in massa, 47% fibra acrilica Sunbrella® tinto in massa, 3% poliester.

50% blended Sunbrella® acrylic fiber mass dyed, 47% Sunbrella® acrylic fiber mass dyed, 3% polyester.

50% fibre acrylique Sunbrella® recyclée teintée en masse, 47% fibre acrylique Sunbrella® teintée en masse, 3% de polyester.

50% fasergefärbtes Sunbrella® Polyacryl, 47% fasergefärbtes Sunbrella® Polyacryl, 3% Polyester.

50% fibra acrílica Sunbrella® reciclada tintada en masa, 47% fibra acrílica Sunbrella® tintada en masa, 3% poliéster.

50% fibra acrílica Sunbrella® reciclada tingida em massa, 47% fibra acrílica Sunbrella® tingida em massa, 3% de poliéster.

%50 geri dönüştürülmüş akrilik elyaf Sunbrella® çözelti halindeyken boyanmış, %47 akrilik elyaf Sunbrella® çözelti halindeyken boyanmış, %3 polyester.

50% переработанное акриловое волокно Sunbrella®, окрашенное в массе, 47% акриловое волокно Sunbrella®, окрашенное в массе, 3% полиэстер.

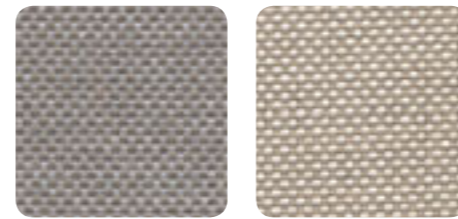

grigio
Sunbrella® .136
275 gr/m²

canvas
Sunbrella® .141
275 gr/m²

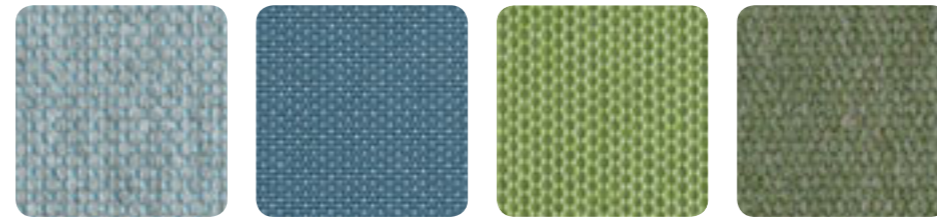

ghiaccio
Sunbrella® .138
275 gr/m²

adriatic
Sunbrella® .142
260 gr/m²

avocado
Sunbrella® .139
260 gr/m²

giungla
Sunbrella® .140 ★
340 gr/m²

tessuto acrilico tinto massa

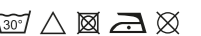

100% fibra acrilica tinto in massa. Trattamento idrorepellente, antimacchia, antimuffa. Solidità alla luce 7/8. Lavabile a 30°.

100% acrylic fiber mass dyed. Water repellent treatment, dirt repellent and anti-mould treatment. 7/8 light fastness. Washable at 30°.

100% fibre acrylique teintée en masse. Traitement imperméable, anti-taches et anti-moisissure. Résistance à la lumière 7/8. Lavable à 30°.

100% fasergefärbtes Polyacryl. Wasserabweisend Ausrüstung, gegen Flecken und Schimmel ausgerüstet. Lichtechtheit 7/8. Waschbar bei 30°.

100% fibra acrílica tintada en masa. Tratamiento hidropelente, protección antimanchas, antimoho. Solidez a la luz 7/8. Lavable a 30°.

100% fibra acrílica tingida em massa. Tratamento hidrorrepelente, antimancha e antimoho. Resistência à luz 7/8. Lavável a 30°.

%100 akrilik elyaf çözelti halindeyken boyanmış. Su itici, leke itici, küf önleyici ile muamele edilmiş. Işık haslığı 7/8. 30°de yıkanabilir.

100% акриловое волокно окрашенное в массе. Водоотталкивающая, пятноустойчивая и противоплесневая обработка. Светостойкость 8/8. Стирать при 30°.



lino .152
280 gr/m²

trattamento laminato

(Su richiesta - On request - Sur demande - Auf Anfrage - Bajo pedido - Sob encomenda - İstek üzerine - По запросу)

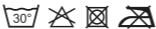

Il tessuto è accoppiato internamente con un film in poliuretano che lo rende impermeabile. La parte accoppiata in poliuretano non deve essere esposta al sole. Applicabile su richiesta con quantità minima su tessuti acrilici Sunbrella®.

The fabric is bonded with a polyurethane film that makes it waterproof. The polyurethane laminated surface should not be exposed to direct sunlight. Applicable on Sunbrella® acrylic fabrics on request with a minimum quantity.

Le tissu est doublé en interne avec un film de polyuréthane qui le rend imperméable. La partie en polyuréthane ne doit pas être exposée au soleil. Applicable sur demande avec une quantité minimale sur les tissus acryliques Sunbrella®.

Das Gewebe ist innen mit einer Polyurethanfolie verbunden, die es wasserdicht macht. Das mit Polyurethan verbundene Teil darf nicht der Sonne ausgesetzt werden. Auf Anfrage mit Mindestmenge auf Sunbrella® Polyacryl Gewebe anwendbar.

El tejido está acoplado internamente con una película de poliuretano que lo hace impermeable. La parte acoplada de poliuretano no debe exponerse al sol. Aplicable bajo pedido con una cantidad mínima en tejidos acrílicos Sunbrella®.

O tecido é dublado com filme interno de poliuretano que o torna impermeável. O lado que possui o filme de poliuretano não pode ser exposta ao sol. Aplicável sob encomenda, com quantidade mínima, em tecidos acrílicos Sunbrella®.

Kumaş, su geçirmez hale getiren bir poliüretan film ile dahili olarak birleştirilmiştir. Birleştirilmiş poliüretan bölümler güneşe maruz bırakılmamalıdır. Sunbrella® akrilik kumaşlar üzerine minimum miktarda istek üzerine uygulanabilir.

Ткань внутренне соединена с полиуретановой пленкой, которая делает ее водонепроницаемой. та часть, где имеется добавка полиуритана не выставлять на солнце. Применяется по запросу с минимальным количеством на акриловых тканях Sunbrella®.

tessuto acrilico stampato



Fibra acrilica 100% stampa digitale. Solidità alla luce ó. Lavabile a 30°.

100% acrylic fiber with digital print. ó light fastness. Washable at 30°.

100% fibre acrylique impression numérique. Résistance à la lumière ó. Lavable à 30°.

100% Polyacrylfaser mit Digitaldruck. Lichtechtheit ó. Waschbar bei 30°.

100% fibra acrílica impresión digital. Solidez a la luz ó.Lavable a 30°.

100% fibra acrílica estampa digital. Resistência à luz ó. Lavável a 30°.

%100 dijital baskı akrilik elyaf. Işık haslıđı ó. 30°de yıkanabilir.

100% акриловое волокно с цифровым рисунком, окрашенное в процессе производства.

Светостойкость б. Стирка при 30°.



tropical .081

190 gr/m²

TECH

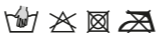

50% vinile e 50% poliestere. Trattamento idrorepellente, antimacchia, antimuffa, ignifugo e antibatterico. Solidità alla luce ó. Lavare a mano in acqua fredda. Alla base dei cuscini seduta comodo TECH panama viene applicata una rete a maglia larga in poliestere per permettere la traspirazione.

50% vinyl and 50% polyester. The treatment makes the coating: water repellent, and resistant to staining, resistant to mold, fire retardant, and antibacterial. ó light fastness. Hand wash in cold water. At the bottom of the Komodo seat cushions, made with TECH panama, the fabric is a polyester wide mesh to allow breathability.

50% vinyle et 50% polyester. Traitement imperméable, anti-taches, anti-moisissures, ignifugé et antibactérien. Résistance à la lumière ó. Laver à la main à l'eau froide. À la base des coussins d'assise komodo TECH panama, un filet de polyester à larges mailles est appliqué pour évacuer la transpiration.

50% Vinyl und 50% Polyester. Wasserabweisend, gegen Flecken und Schimmelbildung ausgerüstet, feuerfest und antibakteriell. Lichtechtheit ó. Handwäsche in kaltem Wasser. Auf der Unterseite der TECH panama Komodo-Sitzkissen ist ein atmungsaktives Polyesternetz mit großer Maschenweite angebracht, um Luftaustausch zu ermöglichen.

50% vinilo y 50% poliéster. Tratamiento para repeler el agua, ignífugo y antibacteriano, protección antimanchas, antimoho. Solidez a la luz ó. Lavar a mano en agua fría. En la base de los cojines de asiento del comodo TECH panama, se aplica una red de poliéster de malla ancha para permitir la transpiración.

50% de vinil e 50% de poliéster. Tratamento hidrorrepelente, antimancha e antimofó, resistente ao fogo e antibacteriano. Resistência à luz ó. Lavar à mão em água fria. Na base das almofadas do assento de comodo TECH panama, é aplicada uma tela de poliéster de malha larga para permitir a transpiração.

% 50 vinil ve % 50 polyester. Su Geçirmez Uygulama,kir tutmaz ve küf önleyici uygulama,yanğın geciktirici ve antibakteriyel uygulama. Işık haslıđı ó. Gerekliğinde, el ile soğuk suda yıkanabilir. Hava alması için Komodo'nun altındaTECH panama minderle, geniş fileli polyester uygulanmıştır.

50% винил и 50% полиэстер. типы обработки: водоталкивающая,пятноталкивающая,пленсеньоталкивающая,невозгораемая и антибактериальная устойчивость к . Светостойкость б. Ручная стирка в холодной воде. в основе подушек комодо материал Tech panama добавлена сетка с широкой вязкой из полиэстера, чтобы материал проветривался.



TECH panama .131

830 gr/m²

cuscino Trill termoformato



Tessuto Sunbrella® Terry: 76% fibra acrilica Sunbrella® tinto in massa e 24% poliestere. Trattamento antimacchia, antimuffa. Solidità alla luce 7/8. Senza cuciture. Lavabile a 30°. Imbottitura: poliuretano espanso rivestito da una membrana TPU waterproof. Densità 40 kg/m³. Sunbrella® Terry Fabric: 76% Sunbrella® acrylic fiber mass dyed and 24% polyester. Dirt repellent and anti-mould treatment. 7/8 light fastness. Seamless. Washable at 30°. Padding: polyurethane foam with a TPU waterproof membrane coating. Density 40 kg/m³.

Sunbrella® Terry Tissu: 76% fibre acrylique Sunbrella® teintée en masse et 24% polyester. Traitement anti-taches et anti-moisissure. Résistance à la lumière 7/8. Sans couture. Lavable à 30°. Rembourrage: mousse polyuréthane revêtu d'une membrane TPU imperméable. Densité 40 kg/m³.

Sunbrella® Terry Gewebe: 76% fasergefärbtes Polyacryl Sunbrella® und 24% Polyester. Gegen Flecken und Schimmel Ausrüstung. Lichtechtheit 7/8. Ohne Nähte. Waschbar bei 30°. Polsterung: Polyurethanschaum mit einer wasserdichten TPU-Membran abgedeckt. Dichte 40 kg/m³.

Tejido Sunbrella® Terry: 76% fibra acrílica Sunbrella® tintada en masa y 24% poliester. Protección antimanchas, antimoho. Solidez a la luz 7/8. Sin costuras. Lavable a 30°. Relleno: espuma de poliuretano recubierto con una membrana de TPU impermeable. Densidad 40 kg/m³.

Tecido Sunbrella® Terry: 76% fibra acrílica Sunbrella® tingida em massa e 24% poliéster. Tratamento antimancha e antimofó. Resistência à luz 7/8. Sem costuras. Lavável a 30°. Enchimento: espuma de poliuretano com cobertura de membrana TPU impermeável. Densidade 40 kg/m³.

Sunbrella® Terry Kumaş: %76 akrilik elyaf Sunbrella® çözüli halindeyken boyanmış ve %24 polyester. Leke itici, küf önleyici ile muamele edilmiş. Işık haslıđı 7/8.Dikişsiz. 30°de yıkanabilir. Dolgu malzemesi: TPU waterproof film ile kaplanmış poliüretan köpük. Yoğunluk 40 kg/m³.

Ткань Sunbrella® Terry: 76% акриловое волокно Sunbrella®, окрашенное в массе и 24% полиэстера. Пятноустойчивая и противоглесневая обработка. Светостойкость 7/8. Без швов. Стирать при 30°. Навивка: пенополиуретан с покрытием из водостойкой мембраны TPU. Плотность 40 кг/м³.



cenere .132

550 gr/m²

tessuto 100% Olefin



100% Olefin tinto in massa. Trattamento antimacchia, antimuffa. Solidità alla luce 7/8. Lavabile a 40°.

100% Olefin mass dyed. Dirt repellent and anti-mould treatment. 7/8 light fastness.

Washable at 40°.

100% Olefin teintée en masse. Traitement anti-taches et anti-moisissure. Résistance à la lumière 7/8. Lavable à 40°.

100% fasergefärbtes Olefin. Gegen Flecken und Schimmel Ausrüstung. Lichtechtheit 7/8. Waschbar bei 40°.

100% Olefin tintada en masa. Protección antimanchas, antimoho. Solidez a la luz 7/8.

Lavable a 40°.

100% Olefin tingida em massa. Tratamento antimancha e antimofó. Resistência à luz

7/8. Lavável a 40°.

%100 Olefin çözüli halindeyken boyanmış. Leke itici, küf önleyici ile muamele edilmiş. Işık haslıđı 7/8. 40°de yıkanabilir.

100% Olefin, окрашенный в массе. Пятноустойчивая и противоглесневая обработка. Светостойкость 7/8. Стирать при 40°.



bianco .155

190 gr/m²



caffè .165

190 gr/m²

tessuto sintetico

Tessuto in filo di poliestere rivestito in pvc.
Fabric is made of a polyester fiber, with a pvc coating.
Tissu en fil de polyester revêtu de pvc.
Gewebe aus PVC-ummantelten Polyesterfasern.

Tejido en hilo de poliéster recubierto de pvc.
Tecido de fibra polyester com cobertura pvc.
PVC kaplı polyester elyaf tekstil.
Ткань из полиэфирных нитей с покрытием из ПВХ.

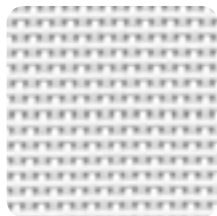

bianco .107
tela 1x1

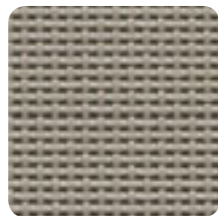

tortora .104
tela 1x1

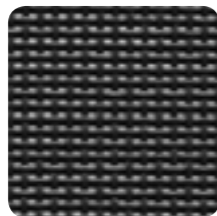

antracite .057
tela 1x1

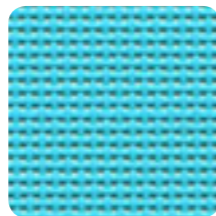

celeste .075
tela 1x1

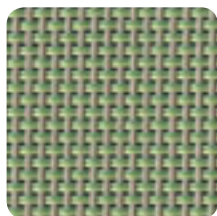

agave .101
tela 2x1

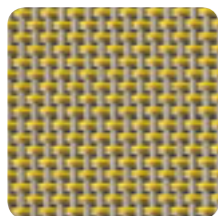

deserto .103
tela 2x1

imbottitura

CUSCINO FOLIO COMFORT

Poliuretano espanso (densità 18 kg/m³) rivestito da fibra di poliestere accoppiata al tessuto. Polyurethane foam (density 18 kg/m³) with a polyester fiber coating bonded to the fabric. Mousse polyuréthane (densité 18 kg/m³) revêtu de fibre de polyester couplé au tissu. Polyurethanschaum (Dichte 18 kg/m³) mit Polyesterfasern beschichtet, gekoppelt mit dem Gewebe. Espuma de poliuretano (densidad 18 kg/m³) cubierta con fibras de poliéster acoplada con el tejido. Espuma de poliuretano (densidade 18 kg/m³) com cobertura fibras de poliéster acoplada ao tecido. Kumaşa birleştirilmiş polyester elyafı kaplanmış genişletilmiş poliüretan (yoğunluk 18 kg/m³). Расширенный полиуретан (плотность 18 кг/м³), покрытый полиэфирным волокном, соединенным с тканью.

CUSCINO NET BENCH - CUSCINO NET RELAX - CUSCINO NET - CUSCINO FIT ARIA

Poliuretano espanso. Densità 28 kg/m³. Polyurethane foam. Density 28 kg/m³. Mousse polyuréthane. Densité 28 kg/m³. Polyurethanschaum. Dichte 28 kg/m³. Espuma de poliuretano. Densidad 28 kg/m³. Espuma de poliuretano. Densidade 28 kg/m³. Poliüretan köpük. Yoğunluk 28 kg/m³. Пенополиуретан. Плотность 28 кг/м³.

CUSCINO SEDUTA ARIA

Poliuretano espanso. Densità 25 kg/m³. Polyurethane foam. Density 25 kg/m³. Mousse polyuréthane. Densité 25 kg/m³. Polyurethanschaum. Dichte 25 kg/m³. Espuma de poliuretano. Densidad 25 kg/m³. Espuma de poliuretano. Densidade 25 kg/m³. Poliüretan köpük. Yoğunluk 25 kg/m³. Пенополиуретан. Плотность 25 кг/м³.

CUSCINO SHELL NET RELAX

Poliuretano espanso su struttura rigida di polipropilene. Densità 70 kg/m³. Polyurethane foam over solid polypropylene frame. Density 70 kg/m³. Mousse polyuréthane sur structure rigide de polypropylène. Densité 70 kg/m³. Polyurethanschaum auf steifer Polypropylengestell. Dichte 70 kg/m³. Espuma de poliuretano sobre estructura rígida de polipropileno. Densidad 70 kg/m³. Espuma de poliuretano sobre estrutura rígida de polipropileno. Densidade

70 kg/m³. Sert polipropilen gövde üzerinde poliüretan köpük minder. Yoğunluk 70 kg/m³. Пенополиуретан. на жесткой конструкции из полипропилена. Плотность 70 кг/м³.

CUSCINO PASSEPARTOUT - CUSCINO RETTANGOLARE

Fibra di poliestere. Polyester fiber. Fibre de polyester. Polyesterfasern. Fibras de poliéster. Fibras de poliéster. Polyester elyaf. Обшивка из полиэстера.

CUSCINO SEDUTA KOMODO - CUSCINO ARREDO ARIA

Poliuretano espanso (densità 25 kg/m³) rivestito da fibra di poliestere (densità 450 gr/m²). Polyurethane foam (density 25 kg/m³) with a polyester fiber coating (density 450 gr/m²). Mousse polyuréthane (densité 25 kg/m³) revêtu de fibre de polyester (densité 450 gr/m²). Polyurethanschaum (Dichte 25 kg/m³) mit Polyesterfasern beschichtet (Dichte 450 gr/m²). Espuma de poliuretano (densidad 25 kg/m³) cubierta con fibras de poliéster (densidad 450 gr/m²). Espuma de poliuretano (densidade 25 kg/m³) com cobertura fibras de poliéster (densidade 450 gr/m²). Polyester elyaf (Yoğunluk 450 gr/m²) kaplı köpük poliüretan (Yoğunluk 25 kg/m³). Пенополиуретан (Плотность 25 кг/м³) с покрытием из обшивки из полиэстера (Плотность 450 гр/м²).

CUSCINO SCHIENALE KOMODO - CUSCINO SCHIENALE ANGOLO KOMODO

Poliuretano espanso (densità 21 kg/m³) rivestito da fibra di poliestere (densità 450 gr/m²). Polyurethane foam (density 21 kg/m³) with a polyester fiber coating (density 450 gr/m²). Mousse polyuréthane (densité 21 kg/m³) revêtu de fibre de polyester (densité 450 gr/m²). Polyurethanschaum (Dichte 21 kg/m³) mit Polyesterfasern beschichtet (Dichte 450 gr/m²). Espuma de poliuretano (densidad 21 kg/m³) cubierta con fibras de poliéster (densidad 450 gr/m²). Espuma de poliuretano (densidade 21 kg/m³) com cobertura fibras de poliéster (densidade 450 gr/m²). Polyester elyaf (Yoğunluk 450 gr/m²) kaplı köpük poliüretan (Yoğunluk 21 kg/m³). Пенополиуретан (Плотность 21 кг/м³) с покрытием из обшивки из полиэстера (Плотность 450 гр/м²).

alluminio verniciato

La verniciatura è a polvere di poliestere.
The painting is with polyester powder.
La peinture est à poudre de polyester.
Die Epoxierung erfolgt mit Polyesterpulver.

El pintado se realiza con polvo de poliéster.
O pó de poliéster é usado para envernizar.
Boyası polyester tozla yapılır.
Окраска производится при помощи порошкового полиэстера.



verniciato bianco .53



verniciato tortora .59



verniciato caffè .57



verniciato antracite .52

laminato HPL

Laminato decorativo ad alta pressione, compatto, omogeneo, non poroso, ad alta densità. Decorative high pressure laminate, solid, homogeneous, non-porous and with a high density. Stratifié décoratif à haute pression, condensé, homogène, pas poreux, haute densité. HPL-Laminat, beständig, homogen, hoch verdichtet.

Laminado decorado a alta presión, compacto, homogéneo, no poroso y de alta densidad. Decorativo e laminado a alta pressão, sólido, homogêneo, não poroso e de grande densidade. Dekoratif yüksek basınçlı laminat, masif, gözeneksiz ve yüksek yoğunluklu. Декоративный ламинат высокого давления, компактный, однородный, непористый, с высокой плотностью.



BIANCO .301
sp. 12 mm



ANTRACITE .303
sp. 12 mm

vetro

Vetro float temperato serigrafato e vetrificato a 700°C. Spessore 10 mm.
Tempered float glass, screen-printed and vitrified at 700° C. 10 mm thick.
Verre float trempé sérigraphié et vitrifié à 700°C. Epaisseur 10 mm.
Sicherheitsglas mit innenliegendem Dekorsiebdruck, verglast bei 700°. Dicke 10 mm.



BIANCO .00



ANTRACITE .02

Vidrio float, templado, serigrafiado y vetrificado a 700°C. Espesor 10 mm.
Vidro float temperado, impresso e vitrificado a 700°C. Espessura 10 mm.
Temperli, üstü baskılı ve 700° C vitrifiye edilmiş. Kalınlık 10 mm.
Сериграфированное закаленное стекло float, производимое при 700°C. Толщина 10 мм.

vetro

Vetro extrachiaro temperato. Spessore 6 mm.
Extra-clear tempered glass. 6 mm thick.
Verre trempé extra clair. Epaisseur 6 mm.
Extra klares gehärtetes Glas. Dicke 6 mm.



vetro .501

Vidrio templado extra claro. Espesor 6 mm.
Vidro temperado extra claro. Espessura 6 mm.
Ekstra nef temperli cam. Kalınlık 6 mm.
Особо прозрачное закаленное стекло. Толщина 6 мм.

durelTOP

DurelTOP è un sistema innovativo di produzione di piani per tavoli studiati per raggiungere i più elevati livelli di praticità, resistenza, robustezza ed eleganza. I piani DurelTOP sono ad alto spessore, formati da un doppio strato tamburato perfettamente chiuso. Prodotti in polipropilene di prima qualità, sono inalterabili all'acqua, resistenti al sole e facili da pulire. DurelTOP è il risultato di una lunga ricerca tecnologica e dell'esperienza decennale nella lavorazione delle materie plastiche della NARDI, da sempre all'avanguardia nell'ambiente contract e giardino.

The DurelTOP is an innovative new system in the production of tabletops developed to reach the highest levels of practicality, resistance, and elegance. The DurelTOP tabletops have a greater thickness, formed by a double layer enclosure perfectly closed. Produced in first quality polypropylene, they are resistant to water, resistant to sunlight, and are easy to clean. DurelTOP is a result of a decade's long research and development in plastics by Nardi, always a leader in the contract and garden sectors.

DurelTOP est un système innovateur de production de plateaux de tables, il est étudié pour retrouver le meilleur niveau de pratique de résistance et d'élégance. Les plateaux DurelTOP sont très épais, formés de doubles couches parfaitement finies. Ce sont des produits en polypropylène de première qualité, ils sont inaltérables à l'eau, résistant au soleil et faciles à nettoyer. DurelTOP est le résultat d'une longue recherche technologique et une expérience décennale dans le travail des matières plastique de la Sté NARDI, toujours à l'avant-garde dans le secteur du contract et jardin.

DurelTOP ist ein neu entwickeltes System für die Produktion von Tischplatten, um ein Höchstmaß an Funktionalität, Widerstandsfähigkeit und Eleganz zu erreichen. Durch das innen verstärkte "Zwei-Schichten-Hohlraum-System" erreicht die DurelTOP Tischplatte einen stärkeren Querschnitt und damit ein Höchstmaß an Festigkeit. Hergestellt aus hochwertigem Qualitätspolypropylen ist sie resistent gegen Wasser und Sonnenlicht und dabei leicht zu reinigen. DurelTOP ist das Ergebnis von 10 Jahren Forschung und Entwicklung auf dem Kunststoffsektor durch Nardi, immer der führende im Bereich Contract und Gartenmöbel.

DurelTOP es un nuevo sistema de fabricación de tableros de mesa estudiado para alcanzar los mas altos niveles de practicidad, resistencia, robustez y elegancia. Los tableros DurelTOP de gran solidez, estan formados por una doble capa perfectamente unida y sellada. Fabricados en polipropileno de primera calidad son inalterables al agua, resistentes al sol y de fácil limpieza. DurelTOP es el resultado de una prolongada investigación tecnológica y de la experiencia acumulada en los mas de diez años que Nardi lleva produciendo materias plasticas, siempre innovando en ambientes contract y jardín.

DurelTOP é um sistema de inovação da produção de tampos de mesa concebidos para atingir a máxima resistência,práticos e elegantes. Os tampos de mesa DurelTOP são formados poruma camada dupla e perfeitamente unida. Produzidos em polipropileno de primeira qualidade, são resistentes ao sol e fáceis de limpar. DurelTOP é o resultado de uma longa investigação tecnológica em materiais plásticos da Nardi, leader em mobiliário de jardim.

DurelTOP, masa tablalarının üretiminde kullanılan yeni bir sistem olup, yüksek seviyede pratiklik, direnç ve de şıklık sunmak amacıyla geliştirilmiştir. DurelTOP masa tablaları fevkalade bir inceleğe sahip olup, kusursuz kapanan çift tabaka çevirme sistemiyle oluşturulmuştur. Nitelikli çamşakından üretilmiş olup, suya ve güneş ışığına karşı dirençli ve temizlenmesi kolaydır. DurelTOP sistemini Contract ve de Bahçe sektöründe her zaman lider olan Nardi'nin uzun araştırmalarının sonucundan doğan, plastikte gelişim olarak adlandırabiliriz.

DurelTOP — это инновационная система производства столешниц, позволяющая изготавливать практичные, прочные, крепкие и эlegantные столешницы. Столешницы DurelTOP обладают высокой плотностью и состоят из двойной панели с мелкопустотным заполнением, полностью закрытой. Изделия из полипропилен высокого качества устойчивы к воде, солнцу и просты в уходе. DurelTOP — это результат многолетних технологических исследований и десятилетнего опыта NARDI в обработке пластмасс, лидера в производстве садовой мебели и контрактном секторе.



impilabile stackable empilable stapelbar apilable empilhável istiflenebilir стекируемые



reclinabile reclining dossier réglable verstellbare Rückenlehne reclinable reclinável sırt pozisyonlu откидной

Tutte le sedute sono dotate di piedini antiscivolo. All chairs are equipped with non-slip feet. Tous les sièges sont équipés avec patins anti-dérapants. Alle Stühle sind mit rutschfesten Fußkappen ausgestattet. Todos los asientos están equipados con tapones antideslizantes. Todos os assentos estão equipados com pés antiderrapantes. Bütün sandalyeler kaymaz ayaklıdır. Ножи всех стульев оснащены противоскользящей резиновой подложкой.

Sui colori scuri, ombre ed altri difetti minori sono più evidenti rispetto ai colori chiari e sono da ritenersi standard. On dark colors, shadows and other minor faults are more evident than on lighter colors and are therefore standard. Sur les couleurs sombres, les ombres et les autres petits défauts sont plus marqués que sur les couleurs claires et sont tout à fait standards. Auf dunklen Farben sind Schatten und andere kleinere Mängel sichtbarer als auf hellen Farben und sind daher als Standard zu betrachten. Las sombras y demás defectos menores son más evidentes sobre los colores oscuros respecto a los colores claros y tienen que considerarse como estándares. Em cores escuras, sombras e outros defeitos menores são mais evidentes do que em cores claras e devem ser considerados standard. Koyu renkler üzerinde, gölgeler ve diğer küçük defolar açık renkler üzerinde olduklarından daha belirginleşmekte ve bu nedenle normal olarak değerlendirilmelidirler. По сравнению со светлыми цветами на темных цветах тени и другие небольшие дефекты более заметны и должны считаться нормой.

Il peso (kg), le misure (cm) e i colori riportati sono indicativi. La NARDI si riserva il diritto di apportare modifiche o varianti senza preavviso. Tutti i modelli sono depositati. Weights (kg), dimensions (cm) and colors are indicative only. NARDI reserves the right to make changes or variations without notice. All models are patented. Le poids (kg), les dimensions (cm) et les coloris indiqués sont fournis purement à titre indicatif. La Firma NARDI se réserve le droit d'apporter toute modification ou variation sans aucun préavis. Tous les modèles sont déposés. Alle Farb-, Maß- (cm) und Gewichtsangaben (kg) sind nicht als fest bindend anzusehen Firma NARDI behält sich das Recht von Änderungen Alle Modelle sind gesetzlich geschützt. El peso (kg), las medidas (cm) y los colores detallados, son indicativos. La firma NARDI se reserva el derecho de modificaciones o variaciones sin previo aviso. Todos los modelos llevan nuestra marca. O peso (kg), as medidas (cm) e as cores indicadas, são indicativos. A NARDI reservase o direito de aportar modificações ou variações sem préaviso. Todos os modelos estão depositados. Ağırlık (Kg), boyutlar (cm) ve renkler gösterme amaçlıdır. NARDI'nin önceden bildirmeden değişiklik yapma hakkı vardır. Bütün modeller patentlidir. Приведенный вес (кг), размеры (см) и цвета являются ориентировочными. Компания NARDI оставляет за собой права вносить изменения и вариации без предварительного предупреждения. Все модели зарегистрированы.



1138 Budapest, Váci út
144-150.(Váci Corner)
Tel. +36 1 611 7646
Fax . +36 1 611 7647
Mobil. +36 30 985 9283
Email. budapest@vivax.hu



4031 Debrecen, István utca 6.
Tel. +36 52 524 540
Fax. +36 52 524 541
Mobil. +36 70 671 0377
Email. vivax@vivax.hu,
tervezes@vivax.hu

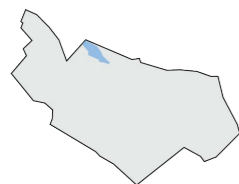

2045 Törökbálint, Tópark utca 1/a.
(MaxCity Lakberendezési
Áruház, II. em. 232.)
Tel . +36 23 444 707
Fax . +36 23 444 708
Mobil. +36 30 968 5232
Email. budapest@vivax.hu



3525 Miskolc, Széchenyi utca 99.
Tel. +36 46 413 920
Fax. +36 46 413 921
Mobil. +36 30 903 9255
Email. vivaxmiskolc@vivax.hu



10101111